

The International Pharmacopoeia

THIRD EDITION

*Pharmacopoea internationalis
Editio tertia*

Volume 5

*Tests and general requirements for dosage forms
Quality specifications for pharmaceutical substances
and tablets*



World Health Organization
Geneva
2003

WHO Library Cataloguing-in-Publication Data

The International pharmacopoeia. Vol. 5, Tests and general requirements for dosage forms; Quality specifications for pharmaceutical substances and dosage forms. – 3rd ed.

1. Dosage forms – standards 2. Pharmaceutical preparations – analysis 3. Pharmaceutical preparations – standards 4. Antimalarials – standards 5. Tablets – standards I. World Health Organization II. Title: Tests and general requirements for dosage forms III. Title: Quality specifications for pharmaceutical substances and dosage forms.

ISBN 92 4 154536 4

(NLM classification: QV 738 MW6)

© World Health Organization 2003

All rights reserved. Publications of the World Health Organization can be obtained from Marketing and Dissemination, World Health Organization, 20 Avenue Appia, 1211 Geneva 27, Switzerland (tel: +41 22 791 2476; fax: +41 22 791 4857; email: bookorders@who.int). Requests for permission to reproduce or translate WHO publication – whether for sale or for noncommercial distribution – should be addressed to Publications, at the above address (fax: +41 22 791 4806; email: permissions@who.int).

The designations employed and the presentation of the material in this publication do not imply the expression of any opinion whatsoever on the part of the World Health Organization concerning the legal status of any country, territory, city or area or of its authorities, or concerning the delimitation of its frontiers or boundaries. Dotted lines on maps represent approximate border lines for which there may not yet be full agreement.

The mention of specific companies or of certain manufacturers' products does not imply that they are endorsed or recommended by the World Health Organization in preference to others of a similar nature that are not mentioned. Errors and omissions excepted, the names of proprietary products are distinguished by initial capital letters.

The World Health Organization does not warrant that the information contained in this publication is complete and correct and shall not be liable for any damages incurred as a result of its use.

Contents

Preface	vii
History	xi
Acknowledgements	xiv
General notices	1
Abbreviations and symbols	2
Tests, methods, and general requirements	5
Monographs for pharmaceutical substances	37
Monographs for tablets	147
Monographs for antimalarial drugs	185
List of reagents, test solutions, and volumetric solutions	235
Amendments and corrigenda to Volumes 1, 2, 3, and 4	255
Supplementary information	315
Index	343

Tests, methods, and general requirements 5

General requirements for dosage forms	7
Ophthalmic preparations	7
Requirements for specific types of ophthalmic preparations	9
Suppositories	11
Tests for dosage forms	14
Disintegration test for suppositories	14
Dissolution test for solid oral dosage forms	18
Test for extractable volume for parenteral preparations	27
Microbial purity of pharmaceutical preparations	28
Test for bacterial endotoxins	30
Test for sterility of non-injectable preparations	32
Visual inspection of particulate matter in injectable preparations	33

Monographs for pharmaceutical substances (Latin names)	37
Albendazolum	39
Alcuronii chloridum	41
Amoxicillinum trihydricum	43
Atenololum	47
Benznidazolum	49
Benzoylis peroxidum cum aqua	51
Captoprilum	54
Chlorali hydras	57
Chloramphenicoli natrii succinas	58
Ciclosporinum	62
Ciprofloxacini hydrochloridum	65
Ciprofloxacinum	68
Clindamycini phosphas	71
Dacarbazinum	74
Diethyltoluamidum	77
Dinitrogenii oxidum	78
Dithranolum	86
Erythromycini lactobionas	90
Etoposidum	92
Heparinum calcicum	95
Heparinum natricum	99
Idoxuridinum	102
Isosorbidi dinitras dilutus	105
Ketoconazolum	108
Levamisoli hydrochloridum	110
DL-Methioninum	112
Methylrosanilini chloridum	114
Metronidazoli benzoas	117
Nifedipinum	119
Nonoxinolum 9	122
Oxygenium	126
Prednisoloni natrii phosphas	132
Protamini sulfas	135
Retinolum densatum oleosum	138
Selenii disulfidum	140
Sulfadiazinum argentum	142
Tropicamidum	144

Monographs for tablets (Latin names) 147

Allopurinoli compressi	149
Carbamazepini compressi	150
Codeini phosphatis compressi	152
Colchicini compressi	153
Dexamethasoni compressi	155
Diloxanidi furoatis compressi	157
Doxycyclini hyclatis compressi	159
Erythromycini ethylsuccinatis compressi	161
Erythromycini stearatis compressi	163
Ethambutoli hydrochloridi compressi	165
Ibuprofeni compressi	167
Indometacini compressi	168
Isoniazidi compressi	170
Morphini sulfatis compressi	171
Pethidini hydrochloridi compressi	172
Phenobarbitali compressi	174
Phenytoini natrici compressi	176
Praziquanteli compressi	177
Prednisoloni compressi	179
Pyranteli embonatis compressi	181

Monographs for antimalarial drugs (Latin names) 185

Artemetherum	187
Artemetheri capsulae	190
Artemetheri compressi	193
Artemetheri injectio	195
Artemisininum	198
Artemisinini capsulae	202
Artemisinini compressi	205
Artemotilum	209
Artemotili injectio	212
Artenimolum	215
Artenimoli compressi	218
Artesunatum	222
Artesunati compressi	225
Mefloquini hydrochloridum	228
Proguanili hydrochloridum	231

Supplementary information	315
<hr/>	
Annotated references	317
List of available International Chemical Reference Substances	319
List of available International Infrared Reference Spectra	326
General guidelines for the establishment, maintenance, and distribution of chemical reference substances	328

Preface

*The International Pharmacopoeia*¹ comprises a collection of recommended procedures for analysis and specifications for the determination of pharmaceutical substances, excipients, and dosage forms that is intended to serve as source material for reference or adaptation by any WHO Member State wishing to establish pharmaceutical requirements. The pharmacopoeia, or any part of it, shall have legal status only if a national authority expressly introduces it into appropriate legislature.

The policies and aims of the third edition of *The International Pharmacopoeia*, together with general notices and methods of analysis, are set out in detail in the prefaces of previous volumes.² It has been emphasized that pharmacopoeial specifications represent only one element of the quality assurance of drugs. Increasingly, the selection of monographs is determined by those substances included in the current *WHO Model List of Essential Drugs*.³

Pharmaceutical substances and dosage forms for human use, as described in a monograph of *The International Pharmacopoeia*, should be manufactured according to the requirements of Good Manufacturing Practices (GMP), whether those recommended by WHO or those laid down by the competent national (regional) authority in the country of manufacture. The processes, premises, equipment, and installations should also comply with the provisions of the product licence or marketing authorization, relevant regulations and, in the case of products destined for export, with any binding international norms that would affect their entry onto the market. In many cases this compliance cannot be verified by analysing a sample of the final product against a pharmacopoeial monograph. The national authority will need to ensure that these instructions have been followed by any means at its disposal, including use of appropriate certificates, inspection of the manufacturing site or testing of samples beyond specifications.

Pharmaceutical preparations that are produced on a large scale and will

¹ Published in accordance with World Health Assembly resolution WHA3.10, *WHO Handbook of Resolutions and Decisions*, Vol. 1, 1977, p. 127.

² *The International Pharmacopoeia*, 3rd ed. Geneva, World Health Organization.

Volume 1: *General methods of analysis*, 1979.

Volume 2: *Quality specifications*, 1981.

Volume 3: *Quality specifications*, 1988.

Volume 4: *Tests, methods, and general requirements. Quality specifications for pharmaceutical substances, excipients, and dosage forms*, 1994.

³ WHO Technical Report Series, No. 882, 1998.

be stored before use should undergo testing to show physical and chemical stability during storage over the claimed shelf-life.¹ The requirements of the monographs are not framed to detect all possible impurities. The present tests are designed to determine impurities on which attention should be focused, to fix the limits of those that are tolerable to a certain extent, and to indicate methods for ensuring the absence of those that are undesirable. It is therefore not to be presumed that an impurity can be tolerated because it has not been precluded by the prescribed tests. In some purity tests, limits are indicated additionally in brackets in percentage terms: such limits are given for information only.

The degree of protection provided by compendial standards will depend not only on their technical content but also to a great extent on how they are utilized. The specified tolerances and limits allow for the inherent variations that occur during production and packaging, as well as for subsequent degradation within normal handling and storage conditions and for any acceptable variance of analytical results.

When pharmaceutical standards are used to establish the compliance of products with regulatory requirements, the following principles should apply:

- The interpretation of a monograph must be in accordance with all general requirements and testing methods, texts, or notices pertaining to it as found in this edition.
- No further tolerances are to be applied to the limits prescribed.
- A product is not of pharmaceutical quality unless it complies with all the requirements stated.

As stated in the Twenty-sixth Report of the WHO Expert Committee on Specifications for Pharmaceutical Preparations,² a distinction exists between pharmacopoeial standards and manufacturers' release specifications. Although release specifications must be based on and be compatible with pharmacopoeial specifications, they may differ in several respects, and it is generally the case that manufacturers' specifications for a drug are more exacting than corresponding pharmacopoeial requirements. The manufacturer is entitled to use other methods for routine testing and, on occasions, certain analytical procedures can be omitted by the manufacturer when testing for compliance with pharmacopoeial standards as long as in-process controls and manufacturing process validation studies have already provided the necessary assurances.

The present volume contains quality specifications for 37 pharmaceutical substances and 20 dosage forms as tablets. There is a new and separate section on antimalarial drugs (7 substances and 8 dosage forms, as identified by the Malaria Unit of WHO), which was included in order to help combat malaria.

¹ *Quality assurance of pharmaceuticals: a compendium of guidelines and related materials*. Volume 1. Geneva, World Health Organization, 1997.

² WHO Technical Report Series, No. 614, 1977, p. 18.

These specifications were developed with the help of special advisers and experts in the field.

There are also general requirements for dosage forms for ophthalmic preparations and for suppositories, and seven additional tests for dosage forms. The specific requirements for the dissolution test for tablets and capsules are still being developed and the Secretariat of *The International Pharmacopoeia* therefore recommends that dissolution requirements for individual monographs be established with regard to the actual biopharmaceutical characteristics of the representative products on the world market. Until publication of specific requirements, the limits provided by the world's leading compendia should be followed.

The new guidelines for microbial purity of pharmaceutical preparations are intended only to provide information and guidance for manufacturers, essentially for process validation, and those involved in quality assurance within the drug distribution system, for periodic monitoring of finished products.

The test method for bacterial endotoxins is intended for substances for parenteral or sterile administration, and replaces the pyrogen test used so far. The limits are currently being evaluated and, where appropriate, have been added to certain monographs. The test for visible particulate contamination is provided for use only as a simple batch acceptance criterion in commerce, and occasionally for random checking of products in the distribution system to ensure quality control during storage. It should be noted that this test is not suitable for use by manufacturers for the purposes of batch release.

Changes to monographs published in Volumes 2, 3, and 4 have been included in the Amendments, which also provide an updated text on "High-performance liquid chromatography". This brings the method into line with the current situation. Modern analytical techniques such as high-performance liquid chromatography have been recognized in some cases to be more sensitive, more rapid, and more robust, and could potentially save costs. Where resources permit, the more technically advanced methods might be provided as the first choice and the less advanced methods as the alternative.

Reagents presenting a potential health risk, such as chloroform, have been replaced as far as possible.

Furthermore, the present volume has an entirely new section of "Supplementary information", which includes lists of available International Chemical Reference Substances and International Infrared Reference Spectra and guidelines for establishing and distributing International Chemical Reference Substances. There are also annotated references to information on International Nonproprietary Names (INN) for pharmaceutical substances and how they are devised and selected, and to information on how to represent chemical formulae graphically in INN publications.

A questionnaire on how *The International Pharmacopoeia* was used was included in Volume 4, which was published in 1994; the same questionnaire was distributed to a number of relevant institutions in WHO Member States. Results showed that *The International Pharmacopoeia* was generally used by both

industrialized and developing countries as a reference source for developing national standards, for quality testing imported pharmaceutical products, and for quality testing locally manufactured drugs. Other uses included its partial or total adoption, mostly in developing countries, as the national pharmacopoeial or similar standard for product licensing and procurement of pharmaceuticals.

The International Chemical Reference Substances referred to in the monographs may be obtained from the WHO Collaborating Centre for Chemical Reference Substances, Apoteket AB, Produktion & Laboratorier, Centrallaboratoriet (ACL), Prismavägen 2, S-141 75 Kungens Kurva, Sweden. International Infrared Reference Spectra are available from the same source. The purpose of chemical reference substances and infrared reference spectra is to achieve the accuracy and reproducibility of analytical results that are required in the context of pharmacopoeial testing and pharmaceutical control in general.

All comments and suggestions concerning the contents of *The International Pharmacopoeia* will be examined and, should amendments be proposed, they will be considered for inclusion in subsequent volumes.

History

The history of *The International Pharmacopoeia* dates back to 1874 when the need to standardize terminology and to specify dosages and composition of drugs led to attempts to produce an international pharmacopoeial compendium. The first conference, called by the Belgian Government and held in Brussels in 1902, resulted in the Agreement for the Unification of the Formulae of Potent Drugs, which was ratified in 1906 by 19 countries. The outcome considerably influenced the subsequent publication of national pharmacopoeias.

A second agreement, the Brussels Agreement, was drawn up in 1925 and ratified in 1929. This 41-article agreement stipulated that the League of Nations would be responsible for the administrative work to produce a unified pharmacopoeia, and a permanent secretariat of an international organization would coordinate the work of national pharmacopoeial commissions. General principles for the preparation of galenicals, maximal doses, nomenclature, and biological testing of arsenobenzones were included in the articles of this agreement, as was a table of dosage strengths and descriptions for 77 drug substances and preparations.

In response to repeated calls from pharmaceutical experts in various countries that the Brussels Agreement be revised and extended to cover an international pharmacopoeia, the Health Organization of the League of Nations set up a Technical Commission of Pharmacopoeial Experts in 1937. This first committee comprised seven experts from Belgium, Denmark, France, Netherlands, Switzerland, the United Kingdom (Chairman), and the United States of America.

In 1947 the Interim Commission of WHO took over the work on pharmacopoeias previously undertaken by the Health Organization of the League of Nations, and set up an Expert Committee on the Unification of Pharmacopoeias to continue the work of the League's Technical Commission. The aim of the Expert Committee was to produce a draft international agreement for the unification of pharmacopoeias, modifying and extending the existing Agreement for the Unification of the Formulae of Potent Drugs.

In 1948 the First World Health Assembly approved the establishment of the Expert Committee by the Interim Commission. In 1951 this became the Expert Committee on the International Pharmacopoeia; and subsequently, in 1959, the Expert Committee on Specifications for Pharmaceutical Preparations. The panel has always been named the WHO Expert Advisory Panel on the International Pharmacopoeia and Pharmaceutical Preparations.

Article 2 of the WHO Constitution states that one of the functions of the Organization is “to develop, establish and promote international standards with respect to food, biological, pharmaceutical and similar products”. *The International Pharmacopoeia* falls clearly into this category. In this context also the Third World Health Assembly in 1950 adopted a resolution to create the International Nonproprietary Names (INN) Programme in order to identify pharmaceutical substances unambiguously on a worldwide basis and to provide a single non-proprietary name to be used in monographs.

First edition

The Third World Health Assembly, held in May 1950, formally approved the publication of the *Pharmacopoea Internationalis* and recommended, in accordance with Article 23 of the WHO Constitution, “the eventual inclusion of its provisions by the authorities responsible for the pharmacopoeias”. It was thus recommended that the *Pharmacopoea Internationalis* was not intended to be a legal pharmacopoeia in any country unless adopted by the pharmacopoeial authority of that country. From that moment the World Health Organization constituted the Permanent International Pharmacopoeia Secretariat.

The first edition, published with the aim of creating a worldwide, unified pharmacopoeia, relied on collaboration with national pharmacopoeia commissions for its preparation. It was published in two volumes (1951 and 1955) and a supplement (1959) in English, French and Spanish, and was also translated into German and Japanese. Altogether, it included 344 monographs on drug substances, 183 monographs on dosage forms (capsules, injections, tablets and tinctures) and 84 tests, methods, and general requirements.

A large number of national pharmacopoeias and official lists were examined and assistance was also obtained from the International Pharmaceutical Federation (FIP) to determine the selection of substances and products to be described in the pharmacopoeia. Latin was chosen for the monograph titles because of its distinction as an international language. Experts collaborated with the WHO Expert Committee on Biological Standardization with regard to biological products, and with those working in specific divisions, e.g. malaria, maternal and child health, mental health, and venereal diseases, to help collate the required information.

Second edition

The second edition was published in 1967 as *Specifications for the Quality Control of Pharmaceutical Preparations*, with a subtitle classifying it as the second edition of *The International Pharmacopoeia*.

Owing to the development of new analytical techniques such as infrared spectroscopy, chromatography (column, paper and thin-layer), non-aqueous titration, and radioactivity, the second edition incorporated numerous alterations and constituted a revision of the first edition.

The selection of monographs and appendices was based largely on the availability, at the time of preparation, of specifications intended for publication in

national pharmacopoeias and in other volumes of specifications for pharmaceutical quality control. Specifications for 162 pharmaceutical preparations not included in the first edition were introduced in the second edition, while 114 monographs were deleted, based on feedback from the first edition. New analytical methods were also added. The specifications and methods in the monographs were tested in a number of national pharmacopoeial and pharmaceutical quality control laboratories, in pharmaceutical manufacturers' laboratories, and at various pharmacopoeial institutes.

Special thanks were expressed to the authorities of the British Pharmacopoeia and the United States Pharmacopoeia.

Third edition

In 1975 the purpose of *The International Pharmacopoeia* was reconsidered. It was decided that the publication should focus more on the needs of developing countries and recommend only simple, classical chemical techniques that had been shown to be sound. Priority would be given to drugs that were widely used throughout the world, with emphasis on the therapeutic value of these drugs. High priority would be accorded to drugs important to WHO health programmes, and to those likely to contain impurities arising from degradation or due to difficulties in their manufacture. Wherever possible, classical procedures would be used in the analytical methods so that the pharmacopoeia could be applied without the need for expensive equipment. Where a sophisticated analytical method was suggested, an alternative, less complex method would also be proposed.

Since 1979, the drugs appearing in *The International Pharmacopoeia* have been selected from the list of essential drugs based on the first report of the WHO Expert Committee on the Selection of Essential Drugs. Specifications are provided in the monographs for the identification, purity, and content of the essential drugs appearing in the WHO Model List of Essential Drugs, and their updates.

The International Pharmacopoeia currently stands at five volumes: Volume 1 contains general methods of analysis; Volumes 2 and 3, quality specifications for the majority of essential drug substances in the WHO Model List of Essential Drugs; and Volume 4, information on tests, methods, and general requirements and quality specifications for pharmaceutical substances, excipients, and dosage forms. Volume 5, the present volume, contains tests and general requirements for dosage forms and quality specifications for pharmaceutical substances and tablets, which will practically complete the list of monographs for active pharmaceutical substances, and a section on antimalarial drug substances and their most widely used dosage forms.

Acknowledgements

The specifications included in Volume 5 of the third edition were developed during the period 1990–1998 in collaboration with members of the WHO Expert Advisory Panel on the International Pharmacopoeia and Pharmaceutical Preparations, other specialists, and the WHO Collaborating Centres on quality control.

Thanks are also due to the Controller of Her Majesty's Stationery Office, the European Pharmacopoeia Commission and the United States Pharmacopeial Convention, Inc. for providing valuable background material.

The following specialists participated both in person and by correspondence in the preparation of this volume: Professor H.Y. Aboul-Enein, Bioanalytical and Drug Development Laboratory, Department of Biological and Medical Research, King Faisal Specialist Hospital and Research Centre, Riyadh, Saudi Arabia; Professor I. Addae-Mensah, Vice-Chancellor, University of Ghana, Legon, Accra, Ghana; Professor J.-M. Aiache, Laboratory of Biopharmacy, Faculty of Pharmacy, University of Clermont-Ferrand, Clermont-Ferrand, France; Dr K. Akalin, Ministry of Health, Ankara, Turkey; Professor P.I. Akubue, Department of Pharmacology and Toxicology, University of Nigeria, Nsukka, Lagos, Nigeria; Dr H. Ali, Novartis Pharma Ltd, Basel, Switzerland; Dr S.L. Ali, Association of German Pharmacists' Central Laboratory, Eschborn, Germany; Professor H.R. Altorfer, Department of Pharmacy, Swiss Federal Institute of Technology, Zurich, Switzerland; Dr P. Arends, Skagen Apotek, Skagen, Denmark; Dr A. Artiges, European Directorate for the Quality of Medicines, Council of Europe, Strasbourg, France; Dr K. Bailey, Bureau of Drug Research, Health and Welfare, Health Protection Branch, Ottawa, Ontario, Canada; Professor I. Bayer, Budapest, Hungary; Mr J.Y. Binka, Accra, Ghana; Professor H. Blume, Bad Homburg, Germany; Dr Y. Boer, Laboratory of the Dutch Pharmaceutical Society, The Hague, Netherlands; Dr R. Boudet-Dalbin, Faculty of Pharmaceutical Sciences, René Descartes University, Paris, France; Professor D.D. Breimer, Center for Bio-Pharmaceutical Sciences, Sylvius Laboratories, Leiden, Netherlands; Dr Briskot, Bayer AG, Wuppertal, Germany; Dr T. Burat, Drug and Cosmetics Research Department, Central Institute of Hygiene, Ankara, Turkey; Dr M.N. Caetano Pisciotano, Department of Pharmacy, Federal University of Pernambuco, Recife, Brazil; Dr D.H. Calam, National Institute for Biological Standards and Control, Potters Bar, Herts., England; Dr R. Carter, Knoll AG, Basel, Switzerland; Dr G.P. Chiu, The Upjohn Company, Kalamazoo, MI, USA; Dr J.A. Clements, Scientific and Technical Services Division,

Royal Pharmaceutical Society of Great Britain, London, England; Mrs E.M. Cortes Montejano, Ministry of Health and Consumer Affairs, Madrid, Spain; Professor P.F. Coville, School of Pharmacy, University of Otago, Dunedin, New Zealand; Dr E. Demant, Bayer, Pharmaceutical Division, West Haven, CT, USA; Dr A. Dobrotvorsky, Ministry of Health and Medical Industry State Pharmacopoeia Committee, Moscow, Russian Federation; Professor E. Doelker, Vice-Rector Department of Pharmaceutics, University of Geneva, Geneva, Switzerland; Dr Doll, Aventis Pharma HG, Frankfurt am Main, Germany; Professor J.B. Dressman, Institute for Pharmaceutical Technology, Johann Wolfgang Goethe University, Frankfurt am Main, Germany; Dr P.O. Emafo, Benin City, Nigeria; Dr R.R. Engle, Fort Myers, FL, USA; Dr K. Florey, Princeton, NJ, USA; Dr R. Freimanis, Arlington Heights, IL, USA; Dr H. Fukuda, Society of Japanese Pharmacopoeia, Tokyo, Japan; Professor D. Ganderton, Cheriton Bishop, England; Mr C. Ghilardi, Novartis Pharma Ltd, Basel, Switzerland; Dr L.T. Grady, Drug Standards Division, The United States Pharmacopeial Convention, Inc., Rockville, MD, USA; Dr S.A. Hanna, Bristol-Myers Squibb, New Brunswick, NJ, USA; Dr H. Hauth, Novartis Pharma Ltd, Basel, Switzerland; Dr P. Hayes, School of Pharmacy, University of Otago, Dunedin, New Zealand; Dr W. Hecker, Novartis Pharma Ltd, Basel, Switzerland; Dr H. Heimbach, Bayer AG, Wuppertal, Germany; Mr J.-P. Helenport, Rhône-Poulenc Rorer Doma, Antony Cedex, France; Dr M. Hessel, Messer Griesheim GmbH, Duisburg, Germany; Mr A. Holbrook, Zeneca Pharmaceuticals, Macclesfield, Cheshire, England; Mr R.K. Howard, Therapeutic Goods Administration Laboratories, Department of Community Services and Health, Woden, ACT, Australia; Dr Hyung Kook Kim, Division of Drug Standardization, National Institute of Health, Seoul, Republic of Korea; Professor Jin Shaohong, National Institute for the Control of Pharmaceutical and Biological Products, Ministry of Health, Beijing, People's Republic of China; Dr P. Kashemsant, Department of Medical Sciences, Ministry of Public Health, Nonthaburi, Thailand; Dr A. Kaukinen, Helsinki, Finland; Dr E. Keller, Novartis Pharma Ltd, Basel, Switzerland; Mr I. Keuser, Novartis Pharma Ltd, Basel, Switzerland; Dr J. Kincaid, Merck, Manufacturing Division, Westpoint, PA, USA; Mr R.H. King, Division of Standards Development, The United States Pharmacopeial Convention, Inc., Rockville, MD, USA; Mr M. Krummen, Mepha AG, Aesch, Basel, Switzerland; Dr C.S. Kumkumian, Center for Drug Evaluation and Research, Food and Drug Administration, Rockville, MD, USA; Dr T.P. Layloff, The United States Pharmacopeial Convention Inc., Rockville, MD, USA; Mr M.A. Lee, Analytical Sciences Development, SmithKline Beecham Pharmaceuticals, Worthing, England; Dr P. Lim, Palo Alto, USA; Dr K.L. Loening, Topterm, North American Division, Columbus, OH, USA (deceased); Dr H. Ludwig, Novartis Pharma Ltd, Basel, Switzerland; Dr C.B. Lugt, Artecef BV, Maarssen, Netherlands; Dr W. Lund, Royal Pharmaceutical Society of Great Britain, London, England; Dr G. Maillard, The French Pharmaceutical Manufacturers Association, Paris, France; Dr M.K. Majumdar, Jadavpur, Calcutta, India; Dr G. Maldener, Bayer AG, Wuppertal, Germany; Associate Professor L. Martinec, State Institute for Control of Drugs, Bratislava, Slovakia; Dr I.N. Matondo, Scientific Liaison

Office, Harare, Zimbabwe; Mr F. Maxl, Novartis Pharma Ltd, Basel, Switzerland; Dr I.J. McGilveray, Biopharmaceutics Section, Health Protection Branch, Ottawa, Ontario, Canada; Dr J.H.McB Miller, European Directorate for the Quality of Medicines, Council of Europe, Strasbourg, France; Dr N. Miyata, Division of Organic Chemistry, National Institute of Health Sciences, Tokyo, Japan; Mr M.G. Moester, Inspectorate of Health Care, Ministry of Health, Welfare and Sport, Rijswijk, Netherlands; Dr H. Möller, Aventis Pharma Ltd, Frankfurt am Main, Germany; Mr G. Mondain-Monval, Air Liquide Santé France, Paris, France; Mrs Z.J. Montbrun de Reinfeld, National Institute of Hygiene Rafael Rangel, Caracas, Venezuela; Mrs A.B. Moraes da Silva, Escola Nacional de Saúde Pública-Fiocruz, Manguinhos, Rio de Janeiro, Brazil; Professor R.C. Moreau, Paris, France (deceased); Dr H. Müller, Messer Griesheim GmbH, Duisburg, Germany; Mr R.D. Munro, Therapeutic Goods Administration, Woden, ACT, Australia; Dr M. Negwer, Berlin, Germany; Dr Ng Tju Lik, Department of Scientific Services, Institute of Science and Forensic Medicine, Singapore; Dr J.D. Nicholson, Medicines Testing Laboratory, Department of Pharmaceutical Sciences, Royal Pharmaceutical Society of Great Britain, Edinburgh, Scotland; Professor L. Ogunlana, Lanpharm Laboratories, Lagos, Nigeria; Professor T.L. Paál, National Institute of Pharmacy, Budapest, Hungary; Dr P.R. Pabrai, New Delhi, India; Dr H. Partenheimer, Novartis Pharma Ltd, Basel, Switzerland; Professor X. Perlia, Pharmaceutical Institute, Swiss Federal Institute of Technology, Zurich, Switzerland; Dr M. Pesez, Villemomble, France; Dr Pham Hoang Ngoc, National Center for Scientific Research, Institute of Chemistry, Hanoi, Viet Nam; Ms A. Poompanich, Division of Drug Analysis, Department of Medical Sciences, Ministry of Public Health, Nonthaburi, Thailand; Miss M.L. Rabouhans, British Pharmacopoeia Commission, London, England; Professor M. Rafiee-Tehrani, Industrial Pharmacy Research Laboratory, Tehran University of Medical Sciences, Tehran, Islamic Republic of Iran; Professor J. Richter, Berlin, Germany; Dr K. Satiadarma, Bandung, Indonesia; Dr M. Scheiwe, Mepha AG, Aesch, Basel, Switzerland; Dr P.J. Schorn, Offenburg, Germany; Dr G. Schwartzman, Sarasota, FL, USA; Dr K. Sinivuo, National Agency for Medicines, Helsinki, Finland; Dr C.J.P. Siregar, National Quality Control Laboratory of Drug and Food, Ministry of Health, Jakarta, Indonesia; Dr M. Smíd, State Institute for Drug Control, Prague, Czech Republic; Dr R. Soliman, Alexandria, Egypt; Dr J.-M. Spieser, European Directorate for the Quality of Medicines, Council of Europe, Strasbourg, France; Dr H.D. Spitz, International Product Support, The R.W. Johnson Pharmaceutical Research Institute, Raritan, NJ, USA; Dr L. Stefanini-Orešić, Croatian Institute for Medicines Control, Zagreb, Croatia; Dr A. Sulistiowati, National Quality Control Laboratory of Drug and Food, Ministry of Health, Jakarta, Indonesia; Dr S. Sur, Central Laboratory for Quality Control of Medicines, Kiev, Ukraine; Dr Y. Takeda, Society of Japanese Pharmacopoeia, Tokyo, Japan; Professor Tang Lin-hua, Institute of Parasitic Diseases, Chinese Academy of Preventive Medicine, Shanghai, People's Republic of China; Professor K. Thoma, University of Munich, Munich, Germany; Dr W.G. Thomas, Royal Pharmaceutical Society of Great Britain, London, England; Dr H.G. Tölle, F. Hoffman-La Roche Ltd,

Basel, Switzerland; Dr H. Tomankova, International Pharmacopoeia Department, State Institute for Drug Control, Prague, Czech Republic; Dr I. Török, Quality Control Division, National Institute of Pharmacy, Budapest, Hungary; Mrs A.M. Trapletti, F. Hoffman-La Roche Ltd, Basel, Switzerland; Dr P.G. Treaugust, SmithKline Beecham Pharmaceuticals, Worthing, West Sussex, England; Mr R.B. Trigg, British Pharmacopoeia Commission, London, England; Professor Trin Van Quy, National Institute of Drug Quality Control, Hanoi, Viet Nam; Professor Tu Guoshi, Division of Pharmaceutical Chemistry, National Institute for the Control of Pharmaceutical and Biological Products, Ministry of Health, Beijing, People's Republic of China; Professor L. Turakka, National Agency for Medicines, Helsinki, Finland; Dr M. Uchiyama, Japan Pharmacists Education Center, Tokyo, Japan; Dr V. Uziely, Institute for the Standardization and Control of Pharmaceuticals, Ministry of Health, Jerusalem, Israel; Dr J. van Rompay, Quality Assurance, Janssen Research Foundation, Beerse, Belgium; Mr L. Virgili, Bristol-Myers Squibb Company, New Brunswick, NJ, USA; Dr J.P. Vora, Bangalore, India; Professor B. Vrhovac, Department of Medicine, University Hospital Medical School, Zagreb, Croatia; Dr I. Vukušić, Podravka-Food, Pharmaceuticals and Cosmetics Industries, Zagreb, Croatia; Dr E. Wachberger, F. Hoffman-La Roche Ltd, Basel, Switzerland; Mr Wang Cunzhi, Kunming Pharmaceutical Corporation, Kunming, People's Republic of China; Dr B. Warren, Canberra Analytical Laboratories Pty Ltd, Erindale Centre, ACT, Australia; Mrs M. Westermark, Astra Zeneca, Södertälje, Sweden; Professor W. Wieniawski, Polish Pharmacopoeia Commission, Warsaw, Poland; Mr G.T. Williams, Dragon Pharmaceuticals Ltd, Merthyr Tydfil, Wales; Dr J. Withell, Therapeutic Goods Administration Laboratories, Department of Community Services and Health, Woden, ACT, Australia; Dr C. Wongpinairat, Bureau of Laboratory Quality Standard, Department of Medical Sciences, Ministry of Public Health, Nonthaburi, Thailand; Dr Woo Soo On, Pharmaceutical Laboratory, Department of Scientific Services, Institute of Science and Forensic Medicine, Singapore; Professor Xiao-Yu Li, Shanghai Institute of Materia Medica, Chinese Academy of Sciences, Shanghai, People's Republic of China; Professor Yang Zhong-Yuan, Guangzhou Municipal Institute for Drug Control, Guangzhou, People's Republic of China.

Furthermore, comments were obtained from the International Federation of Pharmaceutical Manufacturers Associations, Geneva, Switzerland; the World Self-Medication Industry, London, England; Pharmacopoeial Commissions, national institutes for quality control of drugs, and drug research laboratories, and from the following WHO Collaborating Centres: WHO Collaborating Centre for Drug Quality Control, Therapeutic Goods Administration Laboratories, Department of Community Services and Health, Woden, ACT, Australia; WHO Collaborating Centre for Drug Quality Assurance, National Institute for the Control of Pharmaceutical and Biological Products, Beijing, People's Republic of China; WHO Collaborating Centre for Biopharmaceutical Aspects of Drug Quality Control, Laboratory of Biopharmacy, Faculty of Pharmacy, University of Clermont-Ferrand, Clermont-Ferrand, France; WHO Collaborating Centre for Stability Studies of Drugs, Regional University Hospital,

Nantes, France; WHO Collaborating Centre for Drug Information and Quality Assurance, Budapest, Hungary; WHO Collaborating Centre for Quality Assurance of Essential Drugs, Central Drugs Laboratory, Calcutta, India; WHO Collaborating Centre for Quality Assurance of Essential Drugs, Directorate General of Drug and Food Control, Ministry of Health, Jakarta, Indonesia; WHO Collaborating Centre for Drug Quality Control, State Research Institute for the Standardization and Control of Drugs, Ministry of Health, Moscow, Russian Federation; WHO Collaborating Centre for Drug Quality Assurance, Institute of Science and Forensic Medicine, Singapore; WHO Collaborating Centre for Chemical Reference Substances, National Corporation of Swedish Pharmacies, Central Laboratory, Kungens Kurva, Sweden; WHO Collaborating Centre for International Infrared Reference Spectra, Swiss Federal Institute of Technology, Zurich, Switzerland; WHO Collaborating Centre for Quality Assurance of Essential Drugs, Drug Analysis Division, Department of Medical Sciences, Ministry of Public Health, Nonthaburi, Thailand.

The World Health Organization takes this opportunity to express its gratitude to all those people and institutions involved in the preparation of this Volume 5 and its special thanks to Dr P.O. Emafo, Professor T.L. Paál, and Miss M.L. Rabouhans who also served as Chairpersons of the WHO Expert Committee on Specifications for Pharmaceutical Preparations from 1990 to 1999. Members of the Secretariat involved in the elaboration of the publication were Dr A.P. Mechkovski, Chief, Quality Assurance (until December 1994), Dr S. Kopp-Kubel, Responsible Officer, Quality Assurance, Miss M. Schmid, Technical Officer, Quality Assurance, Dr P. Vanbel, Technical Officer, Quality Assurance and Safety: Medicines and Mrs W. Bonny, Quality Assurance and Safety: Medicines.

General notices

Please refer to The International Pharmacopoeia, Volume 4, pp. 1–8 for an explanation of the presentation of information to be found in this volume.

Abbreviations and symbols

- [α] Angle of rotation in polarized light.
- [α]_D^{20°C} Specific optical rotation, angle of rotation (α) of a liquid or of a substance in solution, measured in degrees (°) of rotation at the wavelength of the sodium D-line (589.3 nanometres) and at a temperature of 20 ± 0.5 °C. For liquids it is calculated with reference to a path length of 100 millimetres and divided by the relative density at 20 °C; for substances in solution it is calculated with reference to a path length of 100 millimetres of a solution containing 1 gram of the substance per millilitre.
- A Absorbance, extent of radiation absorbed by a solution expressed in logarithm, decimal, of the reciprocal of the transmittance.
- $A_{1\text{cm}}^{1\%}$ Specific absorbance, absorbance of a solution containing 1 gram of substance in 100 millilitres of solution (1% solution) and measured at a path length of 1 centimetre.
- ATCC American Type Culture Collection, 10801 University Boulevard, Manassas, VA 20110-2209, USA.
- CAS Reg. Registration Number established by the Chemical Abstracts Service of the American Chemical Society.
- C.I. Colour Index Number (British).
- CIP Collection de Bactéries de l'Institut Pasteur, 25 rue du Docteur Roux, F-75724 Paris Cedex 15, France.
- Cm Culture medium (see "List of reagents, test solutions, and volumetric solutions").
- d* Relative density, dimensionless, ratio of the density (ρ) of a substance to that of a reference substance under specified conditions.

d_{20}^{20}	Relative density, ratio of the mass of a given volume of the substance to that of an equal volume of water, both at 20 °C.
$E_{1\text{cm}}^{1\%}$	This symbol has been replaced by $A_{1\text{cm}}^{1\%}$
IU	International Units.
mol/l	Concentration, amount of substance of solute per 1000 millilitres of solution.
n	Refractive index for electromagnetic radiation in a given medium, dimensionless, ratio of the sine of the angle of incidence of electromagnetic radiation on a medium to the sine of its angle of refraction in the medium.
n_D^{20}	Refractive index, value measured at the wavelength of the sodium D-line (589.3 nanometres) and at a temperature of 20 ± 0.5 °C.
NCIMB	National Collections of Industrial, Food and Marine Bacteria Ltd, 23 St Machar Drive, Aberdeen AB24 3RY, Scotland.
NCTC	National Collection of Type Cultures, Central Public Health Laboratory, Colindale Avenue, London NW9 5HT, England.
NCYC	National Collection of Yeast Cultures, AFRC Food Research, Colney Lane, Norwich NR4 7UA, England.
P	Probability of an event in statistical estimations.
pH	Dimensionless, physical quantity expressing the acidity or alkalinity of a solution, measured as the negative logarithm of the hydrogen-ion concentration or hydrogen-ion activity expressed in moles per litre. The scale, 0–14, represents the acidity and alkalinity, 7 indicating the neutral state, numbers below 7 an increasing acidity, and numbers above 7 an increasing alkalinity.
ρ	Mass density, mass divided by volume.
ρ_{20}	Mass density, the mass of one unit volume of the substance, expressed in kilograms per cubic metre (in <i>The International Pharmacopoeia</i> as grams per millilitre) measured at a temperature of 20 °C.
R	Reagent (see “List of reagents, test solutions, and volumetric solutions”).

The International Pharmacopoeia

R_f	Ratio of fronts, related to fronts. In paper or thin-layer chromatography, ratio of the distance travelled by the substance to that travelled by the mobile phase.
R_r	In chromatography, ratio of the distances travelled by the substance to that of the reference substance.
RS	Reference substance (see “List of reagents, test solutions, and volumetric solutions”).
SI	International System of Units (<i>Système international d’Unités</i>).
TS	Test solution (see “List of reagents, test solutions, and volumetric solutions”).
VS	Volumetric solution (see “List of reagents, test solutions, and volumetric solutions”).

Tests, methods, and
general requirements

General requirements for dosage forms

Ophthalmic preparations

Ophthalmic preparations (eye preparations) are sterile, liquid, semi-solid, or solid preparations that may contain one or more active pharmaceutical ingredient(s) intended for application to the conjunctiva, the conjunctival sac or the eyelids.

The choice of base and any excipients used for the preparation of ophthalmic preparations must be proven through product development studies not to affect adversely either the stability of the final product or the availability of the active ingredients at the site of action. The addition of colouring agents is not recommended.

The different categories of ophthalmic preparations include drops consisting of emulsions, solutions or suspensions, and ointments.

Manufacture

The manufacturing processes should meet the requirements of Good Manufacturing Practices, especially with regard to cross-contamination. The following information is intended to provide very broad guidelines concerning the main steps to be followed during production, indicating those that are the most important.

Throughout manufacturing, certain procedures should be validated and monitored by carrying out appropriate in-process controls. These should be designed to guarantee the effectiveness of each stage of production. In-process controls during production of ophthalmic preparations should include monitoring environmental conditions (especially with respect to particulate and microbial contamination), pyrogens (use of a limulus amoebocyte lysate (LAL) test may be advantageous), pH and clarity of solution, and integrity of container (absence of leakage, etc.). Appropriate limits should be set for the particle size of the active ingredient(s).

It is essential that ophthalmic preparations are sterile. An aseptic manufacturing process is usually employed when the dosage form does not allow routine sterilization methods to be used.¹

Packaging must be adequate to protect ophthalmic preparations from light, moisture, microbial contamination, and damage due to handling and transportation.

General requirements

Containers

The materials for containers and closures should not adversely affect the quality of the preparation or allow diffusion of any kind into or across the material of the container into the preparation. The container should be fitted with a closure

¹ "Methods of sterilization", *The International Pharmacopoeia*, 3rd ed., Volume 4, p. 18.

that minimizes microbial contamination and a device that reveals whether the container has ever been opened.

Visual inspection

Inspect the ointments, aqueous or oily solution, suspensions, or emulsions.

Evidence of physical and/or chemical instability is demonstrated by noticeable changes in colour and odour.

Sterility

Ophthalmic preparations should comply with the “Test for sterility” (Vol. 4, p. 15).

Particle size

Ophthalmic preparations containing dispersed solid particles should comply with the following test.

Take a quantity of the preparation (shake the container gently if necessary) corresponding to at least 10 µg of solid active ingredient and place in a counting cell or spread in a thin layer on a slide. Firmly apply a cover-glass and scan the whole area of the sample under a microscope.¹

For each 10 µg of solid active substance not more than 20 particles should have a maximum dimension greater than 25 µm and not more than two of these particles should have a maximum dimension greater than 50 µm. None of the particles should have a maximum dimension greater than 90 µm.

Labelling

Every pharmaceutical preparation must comply with the labelling requirements established by Good Manufacturing Practices.

The label on the immediate container should include:

- (1) the name of the pharmaceutical product;
- (2) the name(s) of the active ingredient(s); International Nonproprietary Names (INN) should be used wherever possible;
- (3) the concentration(s) of the active ingredient(s) and the amount or the volume of preparation in the container;
- (4) the batch (lot) number assigned by the manufacturer;
- (5) the expiry date, the utilization period, and, when required, the date of manufacture;
- (6) any special storage conditions or handling precautions that may be necessary;
- (7) if applicable, the period of use after opening the container;
- (8) directions for use, warnings and precautions that may be necessary;

¹ For practical reasons, the whole sample is first scanned at low magnification (e.g. ×50) and particles >25 µm are identified. The larger particles can then be measured at a higher magnification (e.g. ×200–×500).

- (9) the name and address of the manufacturer or the person responsible for placing the product on the market;
- (10) if applicable, the name(s) and concentration(s) of antimicrobial agent(s) and/or antioxidant(s) incorporated in the preparation; and
- (11) the statement “This preparation is sterile”.

For single-dose containers the following minimum information should appear on the container (provided that the label on the packaging bears the information stated above):

- (1) the name(s) of the active ingredient(s); International Nonproprietary Names (INN) should be used wherever possible;
- (2) the concentration(s) of the active ingredient(s) and the volume of the preparation in the container;
- (3) the name of the manufacturer; and
- (4) the type of preparation.

Multidose preparations

Unless the active ingredient itself has antimicrobial activity, ophthalmic preparations supplied as multidose preparations may include a suitable antimicrobial agent. The antimicrobial activity should remain effective throughout the entire period of use.

Storage

Ophthalmic preparations should maintain their integrity throughout their shelf-life when stored at the temperature indicated on the label. If not otherwise stated, the storage temperature should not exceed 25°C. Special storage recommendations or limitations are indicated in individual monographs.

Requirements for specific types of ophthalmic preparations

Ophthalmic drops

Ophthalmic drops (eye drops) are sterile aqueous or oily solutions, suspensions, or emulsions intended for instillation into the conjunctival sac.

Ophthalmic drops should be clear and practically free from particles when examined under suitable conditions of visibility.

“Water for injections” (Vol. 4, p. 132) should be used in the manufacture of aqueous ophthalmic drops.

The preparation of aqueous ophthalmic drops requires careful consideration of the need for isotonicity, a certain buffering capacity, the desired pH, the addition of antimicrobial agents and/or antioxidants, the use of viscosity-increasing agents, and the choice of appropriate packaging.

Ophthalmic drops are considered isotonic when the tonicity is equal to that of a 0.9% solution of sodium chloride. The eye can usually tolerate solutions equivalent to 0.5–1.8% of sodium chloride.

Ideally, the pH of ophthalmic drops should be equivalent to that of tear fluid, which is 7.4. However, the decision to add a buffering agent should be based on stability considerations. The pH selected should be the optimum for both stability of the active pharmaceutical ingredient and physiological tolerance. If a buffer system is used, it must not cause precipitation or deterioration of the active ingredient. The influence on the lachrymal flow should also be taken into account.

Visual inspection

Evidence of physical instability is demonstrated by the cloudiness of aqueous solutions, due to the formation of a precipitate.

Containers

Ophthalmic drops are normally supplied in suitable multidose containers that allow successive drops of the preparation to be administered. The container should be fitted with a tamper-evident device. The maximum volume of the preparation in such a container should be no more than 10 ml, unless otherwise specified and authorized. Multidose ophthalmic drop preparations may be used for up to 4 weeks after the container is initially opened. Droppers supplied separately should also comply with the “Test for sterility” (Vol. 4, p. 15).

Ophthalmic drops may also be provided in suitable single-dose containers that will maintain the sterility of the contents and the applicator up to the time of use.

It is recommended that single-dose containers for surgical use should not include any antimicrobial agents.

Ophthalmic emulsions

Ophthalmic emulsions are generally dispersions of oily droplets in an aqueous phase. There should be no evidence of breaking or coalescence.

Ophthalmic suspensions

Ophthalmic suspensions contain solid particles dispersed in a liquid vehicle; they must be homogeneous when shaken gently and remain sufficiently dispersed to enable the correct dose to be removed from the container. A sediment may occur, but this should disperse readily when the container is shaken, and the size of the dispersed particles should be controlled. The active ingredient and any other suspended material must be reduced to a particle size small enough to prevent irritation and damage to the cornea.

Visual inspection

Evidence of physical instability is demonstrated by the formation of agglomerates or precipitates in aqueous solutions (suspensions) that do not disperse when the solution is shaken gently.

Ophthalmic ointments

Ophthalmic ointments are sterile, homogeneous, semi-solid preparations intended for application to the conjunctiva or the eyelids.

They are usually prepared from non-aqueous bases, e.g. soft paraffin (Vaseline), liquid paraffin, and wool fat. They may contain suitable additives, such as antimicrobial agents, antioxidants, and stabilizing agents.

Organoleptic inspection

Evidence of physical instability is demonstrated by:

- a noticeable change in consistency, such as excessive “bleeding” (separation of excessive amounts of liquid) or formation of agglomerates or grittiness;
- discoloration;
- emulsion breakdown;
- crystal growth;
- shrinking due to evaporation of water; or
- evidence of microbial growth.

Uniform consistency

Ophthalmic ointments should be of uniform consistency. When a sample is rubbed on the back of the hand, no solid components should be noticed.

Containers

Ophthalmic ointments are normally supplied in small, sterilized, collapsible tubes fitted with a tamper-evident applicator. The containers or the nozzles of the tubes are shaped so that the ointment can be applied without contaminating what remains in the tube. The content of such a container is limited to not more than 5 g of the preparation.

Suitable single-dose containers may also be used.

Suppositories

Suppositories are solid preparations which may contain one or more active pharmaceutical ingredient(s) intended for rectal application. They are normally used for local action or systemic absorption of the active ingredient(s). They usually melt, soften, or dissolve at body temperature.

Suppositories are usually prepared from excipients or bases such as cocoa butter, hard fat, glycerinated gelatin, hydrogenated vegetable oils and macrogols. They may also contain additives, such as adsorbents, surface-active agents, viscosity-influencing agents, antioxidants, antimicrobials, and authorized colouring agents.

Any excipients used for the preparation of suppositories must be proven through product development studies not to affect adversely either the stability of the final product or the availability of the active ingredient(s) at the site of action; incompatibility between any of the components of the dosage form should be avoided.

Manufacture

The manufacturing processes should meet the requirements of Good Manufacturing Practices, especially with regard to cross-contamination. The following information is intended to provide very broad guidelines concerning the main steps to be followed during production, indicating those that are the most important.

Throughout manufacturing, certain procedures should be validated and monitored by carrying out appropriate in-process controls. These should be designed to guarantee the effectiveness of each stage of production.

Where the active ingredient is suspended in the suppository base, appropriate limits should be set for the particle size.

Suppositories may be manufactured by moulding or compressing powdered material into a suitable shape, or by encapsulating a semi-solid mass into soft gelatin. Rectal capsules are in general similar to soft capsules, except that they may have lubricating coatings.

Moulded suppositories are the most common type. They are usually obtained by pouring the medicated mass, sufficiently liquefied by heating, into suitable moulds. The suppositories solidify on cooling. In certain cases, it is also possible to use the cold-moulding compression procedure in a suitable press.

Packaging must be adequate to protect suppositories from light, excessive temperature, moisture, and damage due to handling and transportation. It is necessary to ensure that the suppositories can be released from the packaging material easily and without damage.

General requirements

Visual inspection

Suppositories are elongated, smooth and have a uniform texture and appearance. They may also consist of several layers.

Evidence of physical and/or chemical instability is demonstrated by noticeable changes in:

- surface texture or form; and
- colour and odour.

Disintegration

Suppositories should comply with the “Disintegration test for suppositories” (p. 14), unless intended for modified release. Unless otherwise stated in the individual monograph, for each of the three suppositories, examine the state of the sample after 30 minutes for fat-based suppositories and rectal capsules, and after 60 minutes for water-soluble based suppositories.

Uniformity of mass

See the general requirements for “Uniformity of mass for single-dose preparations” (Vol. 4, p. 47). Not more than two of the individual masses should deviate from the average mass by more than 5%, and none by more than 10%.

Uniformity of content

See the general requirements for “Uniformity of content for single-dose preparations” (Vol. 4, p. 46). Preparations with an active ingredient content of less than 2 mg, or less than 2% of the total mass, comply with the test, unless otherwise described in the individual monograph and authorized. If the preparation has more than one active ingredient, the requirement applies only to those active ingredients that fall into the above category. If the test for uniformity of content is prescribed for all active ingredients, the test for uniformity of mass is not required.

Containers

Suppositories should be supplied in a well-closed container. The container material should not adversely affect the quality of the preparation, nor should it allow diffusion into or across the material of the container or yield foreign substances into the preparation.

Labelling

Every pharmaceutical preparation must comply with the labelling requirements established by Good Manufacturing Practices.

The label on the immediate container should include:

- (1) the name of the pharmaceutical product;
- (2) the name(s) of the active ingredient(s); International Nonproprietary Names (INN) should be used wherever possible;
- (3) the amount of the active ingredient(s) in each suppository and the number of suppositories in the container;
- (4) the batch (lot) number assigned by the manufacturer;
- (5) the expiry date and, when required, the date of manufacture;
- (6) any special storage conditions or handling precautions that may be necessary;
- (7) directions for use, warnings and precautions that may be necessary;

- (8) the name and address of the manufacturer or the person responsible for placing the product on the market; and
- (9) if applicable, the names and concentrations of the antimicrobial agents and/or antioxidants incorporated in the preparation.

Storage

Suppositories should maintain their shape throughout their shelf-life when stored at the temperature indicated on the label. The storage temperature should not exceed 25 °C or, depending on climatic conditions, up to 30 °C.

Tests for dosage forms

Disintegration test for suppositories

The disintegration test determines whether suppositories soften or disintegrate within a prescribed time when placed in an immersion fluid using the experimental conditions described below.

Disintegration is considered to be achieved when:

- dissolution is complete;
- the components of the suppositories have separated, e.g. melted fatty substances have collected on the surface of the liquid, insoluble powders have fallen to the bottom, and soluble components have dissolved or are distributed in one or more of the ways described in Methods 1 and 2;
- there is softening of the test sample, usually accompanied by an appreciable change of shape without complete separation of the components. The softening process is such that a solid core no longer exists when pressure is applied with a glass rod; or
- rupture of the gelatin shell or rectal capsule occurs resulting in release of the contents.

Method 1 (for water-soluble, hydrodispersible and fat-based suppositories):

This test measures the time elapsed for a suppository placed in water to disintegrate.

Apparatus

The apparatus (Fig. 1) consists of a 60-mm long cylinder of glass or transparent plastic and a metal device consisting of two perforated stainless steel discs, held about 30 mm apart. These discs each have 39 holes, 4 mm in diameter, which are evenly spaced in a concentric pattern. The diameter of the discs is

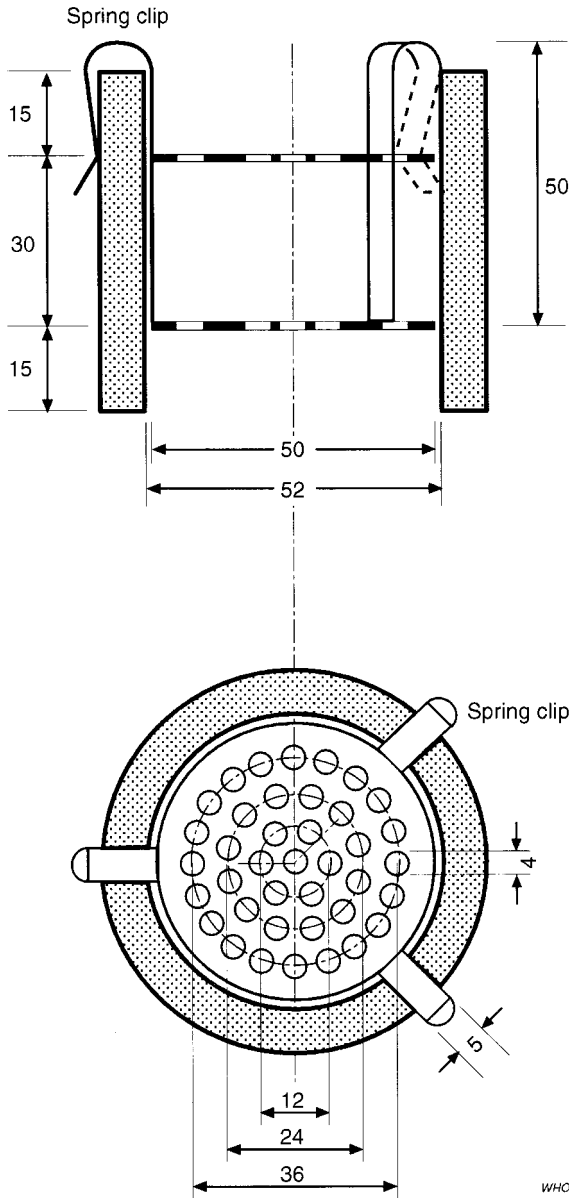

Figure 1. Apparatus for water-soluble, hydrodispersible, and fat-based suppositories
A. Horizontal view
B. Vertical view
Measurements in mm.

British Pharmacopoeia, 1999, Crown copyright material. Reproduced with the permission of the Controller of Her Majesty's Stationery Office.

marginally inferior to that of the interior of the cylinder. Once inserted into the cylinder, the metal device is attached to the rim of the cylinder by means of three spring clips. The test is carried out using three such apparatuses, each containing a single test sample. Each apparatus is placed in a beaker with a minimum capacity of 4 litres filled with water unless otherwise prescribed. The beaker is fitted with a slow stirrer and a support that holds the apparatus vertically 90 mm below the surface of the water so that it can be inverted without emerging from the water.

Recommended procedure

Unless otherwise described in the individual monograph, use water maintained at a temperature of 36–37°C as the immersion fluid. The test requires three suppositories and the procedure is applied to each of the suppositories.

Place the sample on the lower disc of the metal device and then insert it into the cylinder. Place the apparatus into the beaker and invert it every 10 minutes without removing it from the liquid. Repeat the operation with the remaining two suppositories. Record the time required for the disintegration of the suppositories.

Unless otherwise stated in the individual monograph, for each of the three suppositories, examine the state of the sample after 30 minutes for fat-based suppositories and rectal capsules, and after 60 minutes for water-soluble suppositories.

Method 2 (alternative for fat-based suppositories):

This test measures the time elapsed for a suppository placed in water to soften to the extent that it no longer offers resistance when a defined weight is applied.

Apparatus

The apparatus (Fig. 2) consists of a flat-bottomed glass tube about 140 mm long with an internal diameter of 15.5 mm and a two-part rod. The tube is closed with a removable plastic cover that has an opening 5.2 mm in diameter. The rod has two parts: both made of plastic, or the lower part made of plastic and the upper of metal. The rod is 5 mm in diameter and widens at the lower end to a diameter of 12 mm. To the bottom of the lower end is fixed a metal needle 2 mm long and 1 mm in diameter. The upper part of the rod has an adjustable sliding ring and a weighted disc is attached to the top. The two parts are held tightly together for the manual version or separated for the automatic version. The weight of the entire rod should be 30 g ± 0.1 g.

Recommended procedure

Unless otherwise described in the individual monograph, use water maintained at a temperature of 36–37°C as the immersion fluid. The test requires three suppositories and the procedure is applied to each of the suppositories.

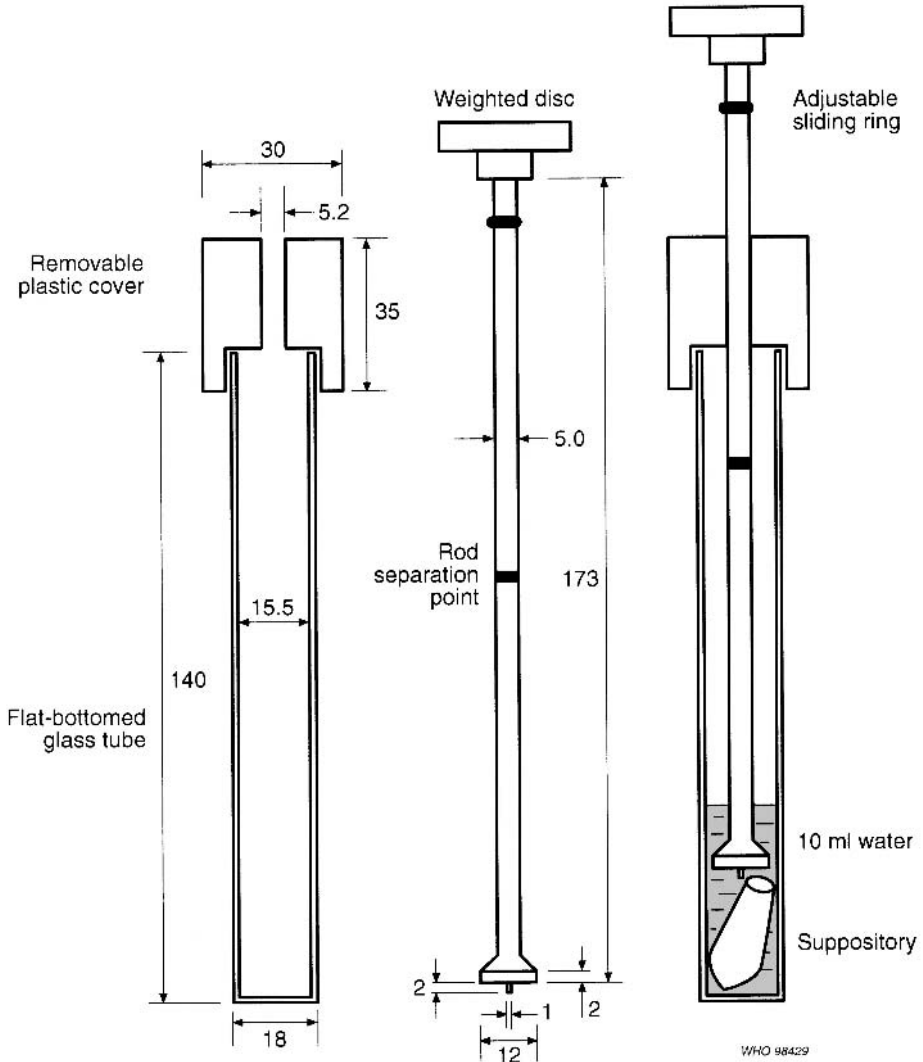

Figure 2. Alternative apparatus for fat-based suppositories
Measurements in mm.

Reproduced with the permission of the European Pharmacopoeia Commission, European Directorate for the Quality of Medicines, Council of Europe.

Place the glass tube containing 10 ml of water in the water-bath and equilibrate at $36.5 \pm 0.5^\circ\text{C}$. Fix the glass tubes vertically and immerse to a depth of at least 7 cm below the surface but without touching the bottom of the water-bath. Introduce a suppository, tip first, into the tube followed by the rod with the free gliding plastic cover into the glass tube until the metal needle touches the flat end of the suppository. Put the cover on the tube. Note the time which

elapses until the rod sinks down to the bottom of the glass tube and the marking reaches the upper level of the plastic cover.

Each of the three suppositories should melt within 30 minutes, unless otherwise stated in the individual monograph.

Dissolution test for solid oral dosage forms

This test determines the amount of active ingredient(s) released from a solid oral dosage form, such as a tablet or a capsule, using a known volume of dissolution medium within a predetermined length of time. This test method may not be applicable to certain oral dosage forms.

Apparatus

All parts of the apparatus, including any metal that may come into contact with the sample to be tested or the dissolution medium, should be made from a chemically inert material and should not adsorb, react or interfere with the preparation or the dissolution medium.

The dissolution assembly should be constructed in such a way that any vibration is reduced to a minimum.

Use an apparatus that allows full visibility of all operations.

The apparatus "Paddle" (Fig. 3) consists of a cylindrical vessel of suitable glass or other suitable transparent material with a hemispherical bottom and a nominal capacity of 1000 ml. The vessel is covered to prevent evaporation of the medium with a cover that has a central hole to accommodate the shaft of the stirrer and other holes for the thermometer and for devices for withdrawal of liquid. The stirrer consists of a vertical shaft with a blade at the lower end. The blade is constructed around the shaft so that it is flush with the bottom of the shaft. When placed inside the vessel, the shaft's axis is within 2 mm of the axis of the vessel and the bottom of the blade is 25 ± 2 mm from the inner bottom of the vessel. The upper part of the shaft is connected to a motor provided with a speed regulator so that smooth rotation of the stirrer can be maintained without any significant wobble. The apparatus is placed in a water-bath that maintains the dissolution medium in the vessel at $37 \pm 0.5^\circ\text{C}$.

The apparatus "Basket" (Fig. 4) consists of the same apparatus as described for "Paddle", except that the paddle stirrer is replaced by a basket stirrer. The basket consists of two parts. The top part, with a vent, is attached to the shaft. It is fitted with three spring clips, or other suitable attachments, that allow removal of the lower part so that the preparation being examined can be placed in the basket. These three spring clips firmly hold the lower part of the basket concentric with the axis of the vessel during rotation. The lower detachable part of the basket is made of welded-seam cloth, with a wire thickness of 0.254 mm diameter and with 0.381 mm square openings, formed into a cylinder with a narrow rim of sheet metal around the top and the bottom. If the basket is to be used with acidic media, it may be plated with a 2.5- μm layer

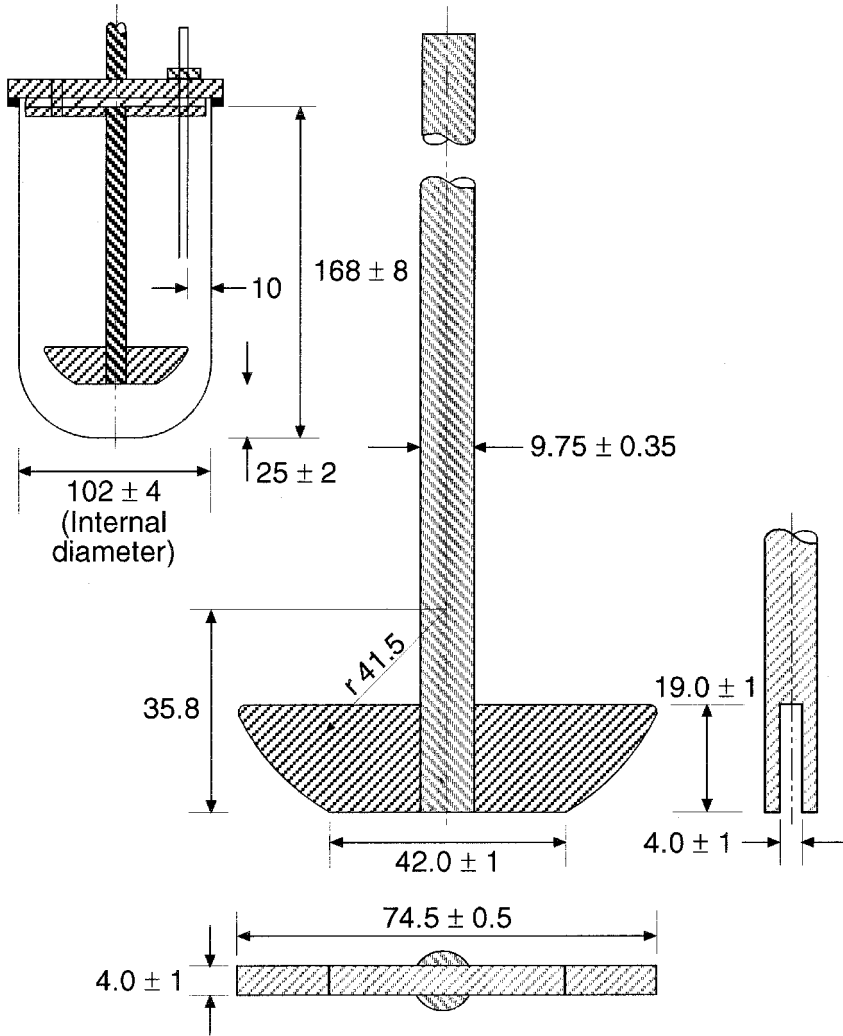

WHO 98431

Figure 3. Paddle

Measurements in mm.

British Pharmacopoeia, 1999, Crown copyright material. Reproduced with the permission of the Controller of Her Majesty's Stationery Office.

of gold. When placed inside the vessel, the distance between the inner bottom of the vessel and the basket is 25 ± 2 mm.

Test conditions

The following specifications are given in the individual monographs:

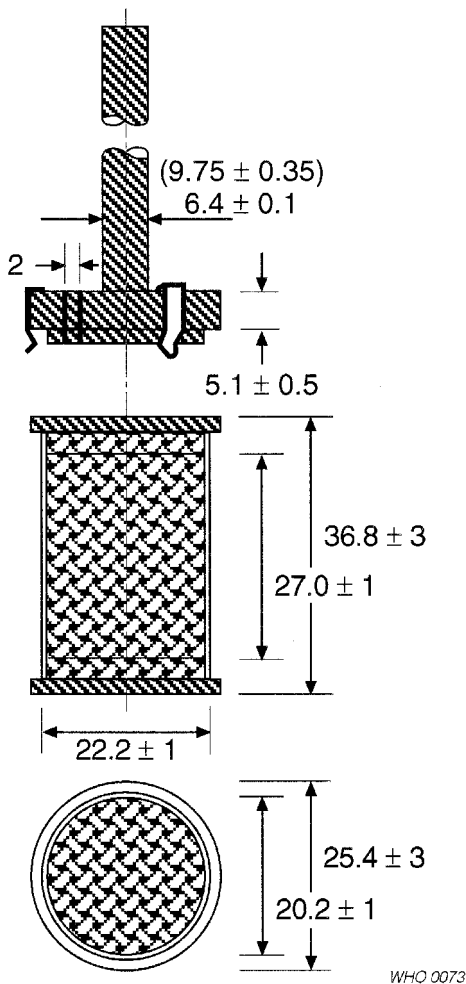

Figure 4. Basket

Measurements in mm.

British Pharmacopoeia, 1999, Crown copyright material. Reproduced with the permission of the Controller of Her Majesty's Stationery Office.

- the apparatus to be used;
- the composition and volume of the dissolution medium;
- the rotation speed of the paddle or basket;
- the preparation of the sample and reference solutions;
- the time, the method, and the amount for sampling of the test solution or the conditions for continuous monitoring;
- the method of analysis; and
- the limits of the quantity or quantities of active ingredient(s) required to dissolve within a prescribed time.

Dissolution medium

If a buffer is added to the dissolution medium, adjust its pH to within ± 0.05 units of the prescribed value. Prior to testing, if necessary, remove any dissolved gases that could cause the formation of bubbles.

Acceptance criteria

The requirements are met if the quantities of active ingredient(s) dissolved from the dosage forms tested conform to the following table, unless otherwise specified in the individual monograph.

Stage	Samples tested	Acceptance criteria
S_1	6	Each unit is not less than $Q+5\%$
S_2	6	Average of 12 units (S_1+S_2) is equal to or greater than Q , and no unit is less than $Q-15\%$
S_3	12	Average of 24 units ($S_1 + S_2 + S_3$) is equal to or greater than Q ; not more than 2 units are less than $Q-15\%$; no unit is less than $Q-25\%$

Continue testing through the three stages unless the results conform at either S_1 or S_2 . The quantity, Q , is the released labelled content of active ingredient as a percentage as specified in the individual monograph; both the 5% and 15% values in the acceptance table are percentages of the labelled content so that these values and Q are in the same terms.

Recommended procedure

(See also *Details of the procedure*, p. 22.)

Ensure that the equipment has been calibrated within the past 6–12 months. Place the volume of dissolution medium, as stipulated in the individual monograph, in the vessel; assemble the apparatus and place it in the water-bath; allow the temperature of the dissolution medium to reach $37\pm 0.5^\circ\text{C}$ and remove the thermometer.

When apparatus “Paddle” is used, allow either one tablet or one capsule of the preparation to be tested to sink to the bottom of the vessel before starting the rotation of the blade, taking care that no air bubbles are present on the surface of the dosage form. In order to stop the dosage form from floating, anchor it to the bottom of the vessel using a suitable device such as a wire or glass helix.

When apparatus “Basket” is used, place either one tablet or one capsule of the preparation to be tested in a dry basket at the beginning of each test. Lower the basket into position before rotation.

Immediately start rotation of the blade or basket at the rate specified in the individual monograph.

Withdraw a sample from a zone midway between the surface of the dissolution medium and the top of the rotating blade or basket, not less than 10 mm below the surface¹ and at least 10 mm from the vessel wall, at the time or time intervals specified (see *Details of the procedure*, section 3.3, p. 24).

Either replace the volume of dissolution medium with a volume equal to that of the liquid removed, or compensate for the loss of liquid by calculation, except where continuous measurement is used.

For filtration of the removed liquid, use an inert filter with a suitable pore size. Use a filter that does not cause significant adsorption of the active ingredient from the solution, and does not contain substances extractable by the dissolution medium that would interfere with the specified method of analysis. Use centrifugation as an alternative with conditions depending on the sample being tested.

Unless otherwise indicated, proceed in parallel with five additional tablets or capsules.

Determine the quantity of active ingredient dissolved in the specified time limit indicated in the individual monograph. The result should be expressed as a percentage of the content stated on the label.

Details of the procedure are given below for those not familiar with the method.

Details of the procedure

The following text is provided to give information and guidance, and is not regarded as an analytical requirement.

1. Verification and validation of equipment (six sets)

- Check the straightness of the shaft visually and with a ruler.
- Examine the paddle or basket for cracks in coating, if applicable.
- Check the paddle or basket for specified dimensions, particularly for any deviation in the evenness of the blade and its distance from the axis.
- Mount the paddle or basket and check its central position.
- Check the apparatus to ensure the desired rotation speed can be maintained within the limits $\pm 4\%$ throughout the test.
- Check the level of vibration of the whole apparatus, preferably measured with a vibration meter, and eliminate any sources of vibration to keep the readings of displacement below 0.3 mm.
- Inspect the paddle or basket, and any portion of the apparatus which will be in contact with the test solutions, for cleanliness; in particular check the paddle/shaft joint for crevices or streaks.

¹ Recommended, 4.5 cm.

- Inspect the vessels for cleanliness and for any abnormalities in dimension or shape, especially of the hemispherical bottom and internal radius. Place in the dissolution test bath.
- Insert the paddle or basket into the unit and adjust it to the specified distance from the bottom of the vessel (25 ± 2 mm).
- Adjust each vessel with a centring gauge. Mark the vessels to permit their easy replacement without losing the correct centred position.
- Calibrate the system with suitable calibrators,¹ according to a scheduled periodic system.

2. Preparation of the dissolution medium

- Select the dissolution medium (see section 6).
- Check the pH of the dissolution medium to two decimal places, using a suitably calibrated pH-meter.
- Dissolved gases can cause bubbles to form which may change the results of the test. In such cases, dissolved gases should be removed prior to testing using a suitable method (e.g. filtration under vacuum or in an ultrasonic water-bath).
- Preheat the medium to 37°C or slightly above, measuring the temperature with precalibrated precision thermometers.

3. Getting ready for the test

3.1 Apparatus

- Adjust the speed to that prescribed in the monograph and ensure that it can be maintained within the limits $\pm 4\%$.
- Ensure there is no significant wobble on any rotating shaft.
- Recheck the centring of the vessels with a gauge and correct if the tilt adjustments were altered.
- Set vertical frame limits, using markers or collars, in order to insert the sample to be tested without causing changes between each test.
- Prepare the test samples ready for dropping into the vessels.

3.2 Water-bath or other suitable heating system

- Transfer the dissolution medium, accurately measured to $\pm 2\%$, to the vessel, check the temperature, and check the volumetric procedure used for subsequent determination as well as any weighing equipment employed.
- Use a transparent water-bath that allows for visual monitoring of the process of disintegration/desegregation, and the possible presence of air.
- Adjust the bath temperature to maintain a temperature of $37 \pm 0.5^\circ\text{C}$ in the vessels.

¹ For example, calibrator tablets such as those available from United States Pharmacopeial Convention Inc.

- Ensure that the fluid in the bath is above the top level of the medium in the vessels.
- Ensure that the position of the water-bath is horizontal.

3.3 Sampling procedures

- Documentation
 - Determine the intervals of sampling as given in the sampling procedure, and decide if a staggered or a simultaneous start for the six tests is convenient.
 - Determine whether the time interval allowed between sampling is sufficient (especially for manual sampling).
 - Record all information concerning:
 - (a) the reference material used and how it is prepared;
 - (b) the use of preevaluated correcting factors in the calculations for any interference from excipients, if known;
 - (c) the preparation of samples for analysis: this must be checked to ensure that it does not interfere with the analysis, e.g. solvent/pH effects;
 - (d) the pH of the solution to be tested and whether it is the same as that of the test medium used;
 - (e) the diluent for the assay if it is not the same as the dissolution medium; and
 - (f) the possible effects, if known, from other solvents.
- Inspection
 - In manual sampling, check that the syringe or other sampling devices are clean.
 - Observe that no interference occurs with the sampling probes.
 - Ensure that the sample is withdrawn from a zone midway between the surface of the dissolution medium and the top of the rotating blade or basket, not less than 10 mm from the vessel wall, and that each subsequent sample is taken in the same way.

3.4 Selecting and checking analytical procedures

- Use the method specified in the corresponding monograph.
- The correct filters should be used to avoid adsorption or interference, unless separation is performed by centrifugation.
- Suitable tubing should be used in automated equipment to avoid adsorption.
- If a spectrophotometric method is used, it is preferable to operate in the linear range of absorption (extinction) values at the specified wavelength.

4. Carrying out the test

- Examine the system to ensure that no air bubbles are present.
- For simultaneous sampling, add the test sample to each of the vessels: immediately start the paddle/basket and stopwatch.
- For staggered sampling (paddle method), it may be necessary to add the test sample when the paddles are rotating. Drop the test sample as close as possible to the centre of the vessel and start the stopwatch immediately. In order to stop the test sample from floating, anchor it to the bottom of the vessel using a suitable device such as a wire or glass helix.
- Check the temperature of the water-bath and that of the dissolution medium at the beginning and at the end of the test and note on the check list (see also section 5).
- Proceed with the sampling.

5. At the end of the test

- Check the temperature of the medium in the vessels and record manually or automatically any deviations from the tolerance of $\pm 0.5^{\circ}\text{C}$.
- Record the speed of rotation.
- Ensure that all data are recorded or printed before discarding the samples (possible problems may only be solved by duplication).
- Note any unusual appearance, such as a silvery hue which indicates the release of dissolved gas.
- Note the condition of any undissolved part of the test sample, such as its position, form, etc. (This is valuable information for problem solving.)
- Check the volume of the contents of one or two vessels to ascertain if evaporation took place. This could affect the analytical results.

6. Suitable dissolution media

The preparation of suitable dissolution media is described under “List of reagents, test solutions, and volumetric solutions” (p. 237). These include Buffer pH = 1.3 TS, Buffer pH = 2.5 TS, Buffer pH = 3.5 TS, Buffer pH = 4.5 TS, Buffer pH = 6.8 TS, Buffer pH = 7.2 TS, Gastric fluid, simulated, TS, and Intestinal fluid, simulated, TS.

7. Checklist

The following checklist is offered as an example for the purpose of monitoring the performance of the system. It does not constitute a part of the requirements.

Proposed checklist for performance of the dissolution test

(one sheet per test)

Name of product

International Nonproprietary Name (INN)

Proprietary Name

Date

	Verified	Further details (values and comments)
Spectrophotometer		
Cleanliness of cells
Description		
Apparatus
Device(s)
– single/multi-spindle (3/6 vessels)
Cleanliness of paddle or basket
Cleanliness of vessel(s)
Dissolution medium (name and composition)
.....		
– pH of buffer
– de-aerated water
Filling of vessel and its position
Level of the dissolution medium
Position of paddle or basket (2.5 cm from the bottom of the vessel)
Insertion of tablets
– time interval
– position
Initial speed
– after 15 minutes
– after 30 minutes
Initial temperature of dissolution medium
– after 15 minutes
– after 30 minutes
Sampling		
Cleanliness of withdrawal device (e.g. needle)
Initial position of device (e.g. 4.5 cm from the surface of the dissolution medium)
Position of device throughout the test

Results

Name of product

Date

Test sample	Percentage of active ingredient dissolved/time					
	Time 1	Time 2	Time 3	Time 4	Time 5	Time 6
1						
2						
3						
4						
5						
6						
Mean value						
Standard deviation						
Relative standard deviation (%)						

Test for extractable volume for parenteral preparations

The determination of extractable volume applies to the following preparations for parenteral use: injections and parenteral infusions.

Recommended procedures

Injections

The volume of the injection in a single-dose container is usually sufficient to permit withdrawal of the nominal dose. The single-dose container does not hold a quantity relative to the declared volume that would present a risk should the whole contents be administered.

Compliance with the requirement for extractable volume is assured by making the filling volume greater than the nominal volume to a degree determined by the characteristics of the product.

Suspensions and emulsions must be shaken prior to withdrawal of the contents and before proceeding with the determination of the density.

Oily or viscous preparations may need to be heated and thoroughly shaken immediately before withdrawal of the contents.

Test for containers with a nominal volume of less than 5 ml

Take five containers. Choose a syringe with a capacity not greater than twice the volume to be measured, fitted with a suitable needle.

Withdraw as much of the contents as possible from one of the five containers to be used in the test, expel any bubbles and transfer this quantity, without emptying the needle, into a dry tared container. Weigh the whole

and determine the mass of the contents. Repeat the procedure with the four remaining containers.

Determine the density of the preparation at the temperature at which the test is carried out. From the mass of the contents of each container, calculate the corresponding volume by dividing by the density.

The preparation complies with the test for extractable volume if the volume measured for each of the five containers is not less than its nominal value.

Test for containers with a nominal volume of 5 ml or more

Take five containers. Choose a syringe with a capacity not greater than twice the volume to be measured, fitted with a suitable needle.

Withdraw as much of the contents as possible from one of the five containers to be used in the test, expel any bubbles and transfer this quantity, without emptying the needle, into a dry measuring cylinder with a capacity such that the volume to be measured is not less than 40% of the nominal volume of the cylinder. Measure the volume transferred. Repeat the procedure with the four remaining containers.

The preparation complies with the test for extractable volume if the volume measured for each of the five containers is not less than its nominal value.

Parenteral infusions

Take one container. Transfer its contents into a dry measuring cylinder with a capacity such that the volume to be measured is not less than 40% of the nominal volume of the cylinder. Measure the volume transferred.

The volume measured is not less than the nominal value stated on the container.

Microbial purity of pharmaceutical preparations

Introduction

The following text is provided to give information and guidance, and is not regarded as an analytical requirement.

Microbial contamination of a product may lead not only to spoilage of the product, with the associated physical and chemical changes, but also to risk of infection for the user. Therefore, oral and topical pharmaceutical products (capsules, tablets, suspensions, creams, patches, etc.), which are not required to be sterile, should be subject to controls for microbial contamination.

Quality assurance and manufacturing controls should be such that organisms capable of proliferation and contamination of the product are within acceptable limits. The microbial limits and batch testing regimes set for the

various categories of products should reflect the types of contamination most likely to be introduced during manufacture. The intended use of the product also needs to be considered.

Microbial limits cannot be formulated to cover every possibility of contamination that may occur. In assessing the results of microbiological testing, the number and types of organisms present should be considered in the context of the proposed use of the product.

Thus, in the manufacture, packaging, storage, and distribution of pharmaceuticals, suitable measures must be taken to ensure their microbial quality.

Limits for medicinal plant materials and methods for detection and estimation of microorganisms are not included in this text. For such preparations reference should be made to *Quality control methods for medicinal plant materials* (WHO, 1998): "Determination of microorganisms".

General requirements

Category	Dosage forms and materials	Recommended criteria
1	Preparations for injection Preparations for ophthalmic use	Sterility (see individual monographs)
2	Preparations for topical use Preparations for the respiratory tract (except those required to be sterile)	Total viable aerobic count not more than 10^2 bacteria and fungi per 1 g or 1 ml Not more than 10^1 enterobacteria and certain other Gram-negative bacteria per 1 g or 1 ml Absence of <i>Pseudomonas aeruginosa</i> in 1 g or 1 ml Absence of <i>Staphylococcus aureus</i> in 1 g or 1 ml
3	Preparations for oral administration Preparations for rectal administration	Total viable aerobic count not more than 10^3 aerobic bacteria per 1 g or 1 ml Not more than 10^2 fungi per 1 g or 1 ml Absence of <i>Escherichia coli</i> in 1 g or 1 ml
4	Preparations for oral administration containing materials of natural origin	Total viable aerobic count not more than 10^4 raw aerobic bacteria per 1 g or 1 ml

Category	Dosage forms and materials	Recommended criteria
4 (Continued)		Not more than 10^2 enterobacteria and certain other Gram-negative bacteria per 1 g or 1 ml Not more than 10^2 fungi per 1 g or 1 ml Absence of <i>Salmonella</i> in 10 g or 10 ml Absence of <i>Escherichia coli</i> in 1 g or 1 ml Absence of <i>Staphylococcus aureus</i> in 1 g or 1 ml

Test for bacterial endotoxins

Introduction

The method for the detection of Gram-negative bacterial endotoxins is based on the gelation of a lysate of amoebocytes (limulus amoebocyte lysate, LAL) from the horseshoe crab, *Limulus polyphemus* or *Limulus tachypleus*. The addition of a solution containing endotoxins to a solution of the lysate produces turbidity, precipitation, or gelation of the mixture.

The rate of reaction depends on the concentration of endotoxin, the pH, and the temperature. The reaction requires the presence of certain divalent cations, an enzyme system, and protein capable of clotting, which are provided by the lysate.

The bacterial endotoxin test (BET) is carried out in a manner that avoids microbial contamination.

Before carrying out the test on the preparation to be examined, it is necessary to verify:

- that the equipment used does not adsorb endotoxins;
- the sensitivity of the lysate;
- the absence of interfering factors.

All equipment used must be free of endotoxins.

Recommended procedure

- Unless otherwise prescribed, the solutions and dilutions used in the test are prepared using water LAL.

Pre-test. Adjust the solution to be examined to pH 6.5–7.5 using hydrochloric acid (0.1 mol/l) LAL, sodium hydroxide (0.1 mol/l) LAL, or a suitable buffer, if necessary. To each of the requisite number of chosen receptacles (for example, slides or tubes) add a volume of the lysate and maintain the temperature at

37 ± 1 °C. Then add to each receptacle an equal volume of the solution to be examined, mixing immediately and gently with the lysate. Incubate the reaction mixture without vibration, avoiding loss of water by evaporation, for a set period of time that has been determined under experimental conditions (usually 20–60 minutes), and check the results.

A positive result is indicated by the formation of a firm gel and no disintegration when the receptacle is gently inverted. If no such gel is formed the result is negative.

Validation. A cross-validation will need to be performed if the lysate used is different to the ones described in the “Introduction”.

Sensitivity of the lysate. Prepare not fewer than four replicate series of two-fold dilutions of endotoxin RS to give concentrations of 2λ, 1λ, 0.5λ, and 0.25λ, where λ is the stated sensitivity of the lysate used. The final dilution in each series must at the minimum give a negative result. Examine the dilutions and a negative control solution consisting of water LAL. Calculate the average of the logarithms of the lowest concentration of endotoxin in each series of dilutions giving a positive result. The antilogarithm of this average gives the estimated lysate sensitivity. If the latter does not differ by more than a factor of 2 from the stated sensitivity, the sensitivity is confirmed and is used for all tests performed using the same lysate.

Interfering factors. Prepare as described under “Sensitivity of the lysate”, but use untreated specimens of the preparation to be examined in which no endotoxins are detectable to prepare the dilutions of endotoxin RS. Use these specimens at the maximum valid dilution (MVD) calculated from the expression:

$$\text{maximum valid dilution} = \frac{\text{endotoxin limit concentration}}{\text{sensitivity of the lysate}}$$

both values being expressed in International Units (IU) of endotoxin per millilitre.

When the endotoxin limit concentration is specified in individual monographs in terms of IU of endotoxin per mg or per IU of product, multiply the endotoxin limit by the concentration of the product in the solution tested (in mg or IU of the product per ml of solution) to obtain the endotoxin limit concentration in IU of endotoxin per ml of solution tested. Where relevant, the multiplication applies to a reconstituted solution of the product as stated on the label.

The preparation to be examined may need to be treated if it contains interfering factors and acts as an inhibitor or an activator as determined under experimental conditions. Suitable treatments are dilution, filtration, neutralization, dialysis, or addition of substances that displace adsorbed endotoxins. The sensitivity of the lysate in the presence of the preparation to be examined should not differ by more than a factor of 2 from the sensitivity of the lysate alone. More sensitive lysates permit a greater dilution of the preparation to be examined and may contribute to the elimination of interference.

Interfering factors passing through a filter with a nominal separation limit corresponding to a relative molecular mass of 10000 to 20000 may be separated adequately by ultrafiltration. Asymmetric membrane filters of cellulose triacetate may be used. The presence of components causing false positive results must be determined. The material containing the endotoxins that is retained on the filter is rinsed with water LAL or a suitable buffer, and the endotoxins are recovered in the water LAL or the buffer. The test volume and the final volume used for the recovery of the endotoxins are determined for each preparation to be examined.

To establish if interfering factors have been eliminated without removing endotoxins, repeat the test using the preparation to be examined, add endotoxin RS, and submit it to the chosen treatment.

Preparation to be examined. Prepare in duplicate as described under “Pre-test”, using the maximum valid dilution of the preparation to be examined, this having been treated if necessary for the elimination of interfering factors. At the same time examine a negative control consisting of water LAL and two positive controls, both of which contain endotoxin RS at a concentration corresponding to twice the stated sensitivity of the lysate and one of which contains the preparation to be examined at the same concentration as in the test (if necessary treated for the elimination of interfering factors after the addition of the endotoxin standard).

The test is valid if the negative and both positive controls give the appropriate result. The endotoxin limit concentrations of the preparations are given in the individual monograph. The product conforms if it complies with the endotoxin limit concentration. However, compliance with this requirement can only be demonstrated by showing that the endotoxin concentration of the product is less than the endotoxin limit concentration.

The preparation to be examined does not comply with the test if a positive result is found for both test mixtures. If a positive result is found for one test mixture and a negative result for the other, repeat the test.

The preparation to be examined complies with the test if a negative result is found for both test mixtures.

Test for sterility of non-injectable preparations

The methods are described under “Test for sterility” (Vol. 4, p. 15).

Certain dosage forms such as ophthalmic drops, ophthalmic ointments, topical semi-solid dosage forms to be applied to damaged skin, etc., require specific sampling plans and preparation of samples.

For the membrane filtration method and for direct inoculation of the medium, determine the number of containers according to the sampling method proposed. The quantity taken should be not less than the minimum and not more than the maximum quantity given below. The quantity used for

each medium, which should be taken from the mixed sample, is also specified in the table.

Sampling plan

Type of preparation	Total pooled for each medium	Quantity to be used
	<i>Membrane filtration method</i>	
Aqueous solution	10–100 ml	5–10 ml
Preparations soluble in water, isopropyl myristate, or other solvents	1–10 g	equivalent to 0.5–1 g
	<i>Direct inoculation method</i>	
Liquid preparations	10–100 ml	5–10 ml
Soluble preparations	1–10 g	equivalent to 0.5–1 g
Insoluble preparations to be suspended or emulsified, e.g. creams and ointments	1–10 g	equivalent to 0.5–1 g

If the membrane filtration method is used for ointments and creams, the preparation being tested may require additional heating up to 40°C (or exceptionally up to 45°C with continuous stirring). The filtration process should be carried out as quickly as possible. If heat is applied and/or a solvent combination is used in the sample preparation, the method should first be validated to ensure that the specific expected bioburden is not affected by these conditions.

Visual inspection of particulate matter in injectable preparations

Particulate contamination of injections and parenteral infusions consists of extraneous, mobile, undissolved particles unintentionally present in the solutions. Disregard any gas bubbles.

The types of preparation for which compliance with this test is required are stated in the individual monograph.

This test provides a simple method for the detection of visible particles. It is performed in accordance with the provisions of Good Manufacturing Practices. The test is not intended for use by a manufacturer for batch release purposes. To ensure that a product will meet pharmacopoeial specifications with respect to visible particulate matter, if and when tested, manufacturers should carry out a 100% inspection and rejection of unsatisfactory items prior to release or use other appropriate means.

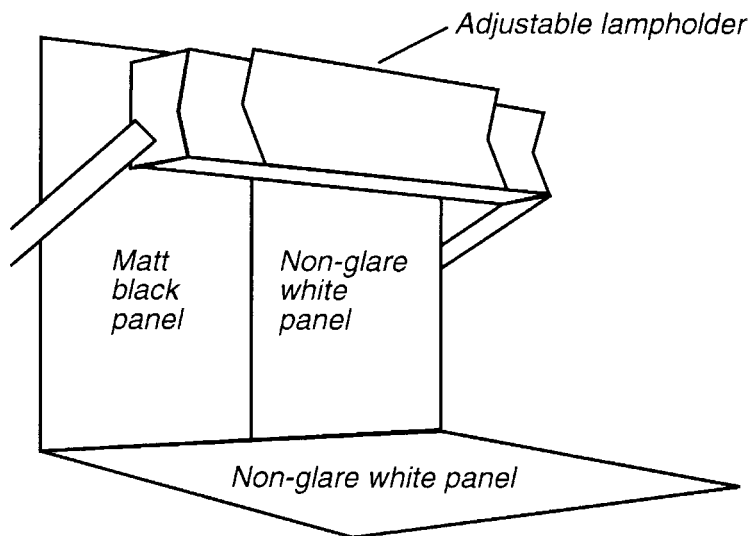

WHO 98430

Figure 5. Apparatus for visible particles

Reproduced with the permission of the European Pharmacopoeia Commission, European Directorate for the Quality of Medicines, Council of Europe.

Subvisible particles and the nature of the particles are not identified by this method.

Apparatus¹

The apparatus (Fig. 5) consists of a viewing station comprising:

- a matt black panel of appropriate size held in a vertical position;
- a non-glare white panel of appropriate size held in a vertical position next to the black panel;
- an adjustable lampholder fitted with a shaded, white-light source and with a light diffuser (a viewing illuminator containing two 13-W fluorescent tubes, each 525 mm in length is suitable). The intensity of illumination at the viewing point is maintained between 2000 lux and 3750 lux for clear glass ampoules. Higher values are preferable for coloured glass and plastic containers.

¹ This method was developed by WHO in collaboration with Group 12 of the European Pharmacopoeia Commission.

Recommended procedure

Gently swirl or invert each individual container, making sure that no air bubbles are introduced, and observe for about 5 seconds in front of the white panel. Repeat the procedure in front of the black panel.

Record the presence of any particles. Repeat the procedure for a further 19 containers.

The preparation fails the test if one or more particles are found in more than one container.

When the test is applied to reconstituted solutions from powder for injections, the test fails if particles are found in more than two containers.

Monographs for
pharmaceutical substances

Albendazolum

Albendazole

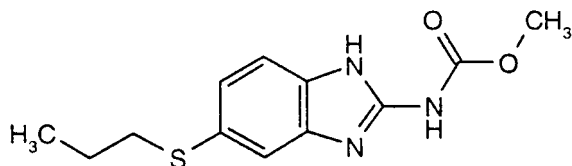

$C_{12}H_{15}N_3O_2S$

Relative molecular mass. 265.3

Chemical name. Methyl 5-(propylthio)-2-benzimidazolecarbamate; CAS Reg. No. 54965-21-8.

Description. A white or almost white powder.

Solubility. Practically insoluble in water; soluble in glacial acetic acid R; slightly soluble in acetone R; very slightly soluble in ethanol (~750 g/l) TS.

Category. Anthelmintic.

Storage. Albendazole should be kept in a well-closed container, protected from light.

Additional information. Melting temperature, about 210°C, with decomposition.

Requirements

Albendazole contains not less than **98.0%** and not more than **101.0%** of $C_{12}H_{15}N_3O_2S$, calculated with reference to the dried substance.

Identity tests

- *Either test A alone or tests B, C, and D may be applied.*

A. Carry out the examination as described under "Spectrophotometry in the infrared region" (Vol. 1, p. 40). The infrared absorption spectrum is concordant with the spectrum obtained from albendazole RS or with the *reference spectrum* of albendazole.

- B. See the test described below under “Related substances”. The principal spot obtained with solution B corresponds in position, appearance, and intensity with that obtained with solution C.
- C. Ignite about 0.1 g; fumes are evolved, staining lead acetate paper R black.
- D. Add about 0.1 g to 3 ml of sulfuric acid (~100 g/l) TS and warm to dissolve. Add about 1 ml of potassium iodobismuthate/acetic acid TS; a reddish brown precipitate is produced.

Sulfated ash. Not more than 1.0 mg/g.

Loss on drying. Dry at 105 °C for 4 hours; it loses not more than 5.0 mg/g.

Related substances. Carry out the test as described under “Thin-layer chromatography” (Vol. 1, p. 83), using silica gel R2 as the coating substance and a mixture of 6 volumes of dichloromethane R, 1 volume of ether R, and 1 volume of glacial acetic acid R as the mobile phase. Apply separately to the plate 10 µl of each of 5 solutions in a mixture of 9 volumes of dichloromethane R and 1 volume of anhydrous formic acid R containing (A) 10.0 mg of Albendazole per ml, (B) 1.0 mg of Albendazole per ml, (C) 1.0 mg of albendazole RS per ml, (D) 0.05 mg of albendazole RS per ml, and (E) 0.025 mg of albendazole RS per ml. After removing the plate from the chromatographic chamber, allow it to dry in a current of warm air, and examine the chromatogram in ultraviolet light (254 nm).

Any spot obtained with solution A, other than the principal spot, is not more intense than the principal spot obtained with solution D (0.5%), and only one spot may be more intense than the principal spot obtained with solution E (0.25%).

Assay. Dissolve about 0.25 g, accurately weighed, in 3 ml of anhydrous formic acid R, and add 40 ml of glacial acetic acid R1. Then add 0.2 ml of 1-naphtholbenzein/acetic acid TS and titrate with perchloric acid (0.1 mol/l) VS until a green colour is obtained as described under “Non-aqueous titration”, Method A (Vol. 1, p. 131).

Each ml of perchloric acid (0.1 mol/l) VS is equivalent to 26.53 mg of $C_{12}H_{15}N_3O_2S$.

Alcuronii chloridum

Alcuronium chloride

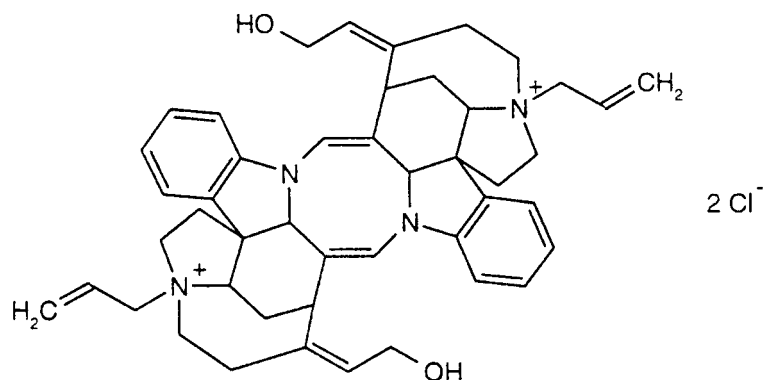

Relative molecular mass. 737.8

Chemical name. *N,N'*-Diallylnortoxiferinium dichloride; CAS Reg. No. 15180-03-7.

Other name. Alcuronium dichloride.

Description. A white to yellow-white, crystalline powder.

Solubility. Soluble in water and ethanol (~750 g/l) TS.

Category. Muscle relaxant.

Storage. Alcuronium chloride should be kept in a tightly closed container at room temperature.

Labelling. The designation Alcuronium chloride for parenteral use indicates that the substance complies with the additional requirements and may be used for parenteral administration. Expiry date.

Additional information. *CAUTION:* Alcuronium chloride is highly toxic. It must be handled with care, avoiding contact with the skin and inhalation of airborne particles. It is hygroscopic.

Requirements

Alcuronium chloride contains not less than **98.0%** and not more than **101.0%** of $C_{44}H_{50}Cl_2N_4O_2$, calculated with reference to the anhydrous substance.

Note: All tests must be carried out immediately after opening the container, and as rapidly as possible.

Identity tests

- *Either tests A and D or tests B, C, and D may be applied.*
- A. Carry out the examination as described under “Spectrophotometry in the infrared region” (Vol. 1, p. 40). The infrared absorption spectrum is concordant with the spectrum obtained from alcuronium chloride RS or with the *reference spectrum* of alcuronium chloride.
- B. The absorption spectrum of a 14 µg/ml solution in phosphate buffer, pH 7.0 (0.067 mol/l) TS, when observed between 230 nm and 350 nm, exhibits a maximum at about 293 nm and a minimum at about 237 nm; the absorbance of a 1-cm layer at the maximum wavelength is about 0.9.
- C. See the test described below under “Related substances”. The principal spot obtained with solution A corresponds in position, appearance, and intensity with that obtained with solution B.
- D. A 20 mg/ml solution yields reaction A described under “General identification tests” as characteristic of chlorides (Vol. 1, p. 112).

Specific optical rotation. Use a 10 mg/ml solution, measured within 10 minutes of preparation, and calculate with reference to the anhydrous substance; $[\alpha]_{\text{D}}^{20^{\circ}\text{C}} = -430^{\circ}$ to -451° .

Heavy metals. Use 2.5 g for the preparation of the test solution as described under “Limit test for heavy metals”, Procedure 3 (Vol. 1, p. 118); determine the heavy metals content according to Method B (Vol. 1, p. 119); not more than 20 µg/g.

Clarity and colour of solution. A solution of 0.10 g in 10 ml of carbon-dioxide-free water R is clear and not more intensely coloured than standard colour solution Yw2 when compared as described under “Colour of liquids” (Vol. 1, p. 50).

Sulfated ash. Not more than 1.0 mg/g.

Water. Determine as described under “Determination of water by the Karl Fischer method”, Method A (Vol. 1, p. 135), using about 0.5 g of the substance; the water content is not more than 0.050 g/g.

pH value. pH of a 10 mg/ml solution in carbon-dioxide-free water R, 6.0–8.5.

Related substances. Carry out the test protected from daylight until the start of detection as described under “Thin-layer chromatography” (Vol. 1, p. 83), using silica gel R6 as the coating substance (a precoated plate from a commercial source is suitable) and a mixture of 1 volume of methanol R and 1 volume of ammonium nitrate TS as the mobile phase. Apply separately to the plate 5 µl of each of 4 solutions in methanol R containing (A) 40 mg of Alcuronium chloride per ml, (B) 40 mg of alcuronium chloride RS per ml, (C) 0.20 mg of alcuronium chloride RS per ml, and (D) 0.10 mg of alcuronium chloride RS per ml. Prior to development allow the plate to dry in a current of cold air and place in a chromatographic chamber. After removing the plate from the chromatographic chamber, allow it again to dry in a current of cold air, and examine the chromatogram in ultraviolet light (254 nm).

Any spot obtained with solution A, other than the principal spot, is not more intense than that obtained with solution C (0.5%), and no more than 3 of these spots are greater than the spot obtained with solution D (0.25%).

Assay. To about 0.3 g, accurately weighed, add 70 ml of acetic anhydride R and place the mixture in an ultrasonic bath for 15 seconds. Titrate the turbid solution with perchloric acid (0.1 mol/l) VS as described under “Non-aqueous titration”, Method A (Vol. 1, p. 131).

Each ml of perchloric acid (0.1 mol/l) VS is equivalent to 36.89 mg of $C_{44}H_{50}Cl_2N_4O_2$.

Additional requirements for Alcuronium chloride for parenteral use

Complies with the monograph for “Parenteral preparations” (see Vol. 4, p. 36).

Bacterial endotoxins. Carry out the test as described under “Test for bacterial endotoxins” (p. 30); contains not more than 17.5 IU of endotoxin RS per mg.

Amoxicillinum trihydricum

Amoxicillin trihydrate

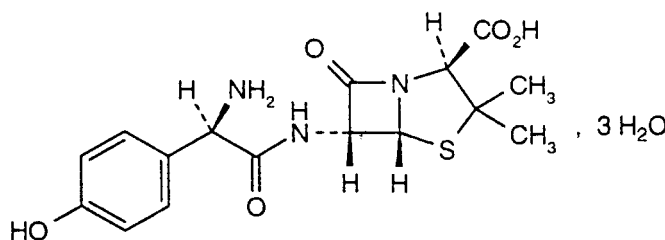

Relative molecular mass. 419.5

Chemical name. (-)-6-[2-Amino-2-(*p*-hydroxyphenyl)acetamido]-3,3-dimethyl-7-oxo-4-thia-1-azabicyclo [3.2.0]heptane-2-carboxylic acid trihydrate; (2*S*,5*R*,6*R*)-6-[(*R*)-2-amino-2-(4-hydroxyphenyl)acetamido]-3,3-dimethyl-7-oxo-4-thia-1-azabicyclo[3.2.0]heptane-2-carboxylic acid trihydrate; 6-[[amino(4-hydroxyphenyl)acetyl]amino]-3,3-dimethyl-7-oxo-4-thia-1-azabicyclo[3.2.0]heptane-2-carboxylic acid trihydrate; CAS Reg. No. 61336-70-7.

Description. A white or almost white, crystalline powder; odourless.

Solubility. Slightly soluble in water and methanol R; very slightly soluble in ethanol (~750 g/l) TS, ether R, and fatty oils; soluble in dilute acids and dilute solutions of alkali hydroxides.

Category. Antibacterial drug.

Storage. Amoxicillin trihydrate should be kept in a tightly closed container, and at a temperature not exceeding 30°C.

Requirements

Amoxicillin trihydrate contains not less than **95.0%** and not more than the equivalent of **102.0%** of C₁₆H₁₉N₃O₅S, calculated with reference to the anhydrous substance.

Identity tests

- *Either test A alone or tests B and C may be applied.*
- A. Carry out the examination as described under “Spectrophotometry in the infrared region” (Vol. 1, p. 40). The infrared absorption spectrum is concordant with the spectrum obtained from amoxicillin trihydrate RS or with the *reference spectrum* of amoxicillin trihydrate.
- B. Carry out the test as described under “Thin-layer chromatography” (Vol. 1, p. 83), using silanized silica gel R3 as the coating substance and a mixture of 9 volumes of a solution containing 15.4 g of ammonium acetate R in 100 ml, the pH of which has been adjusted to 5.0 with glacial acetic acid R, and 1 volume of acetone R as the mobile phase. Apply separately to the plate 1 µl of each of 3 solutions in sodium hydrogen carbonate (40 g/l) TS containing (A) 2.5 mg of Amoxicillin trihydrate per ml, (B) 2.5 mg of amoxicillin trihydrate RS per ml, and (C) a mixture of 2.5 mg of amoxicillin trihydrate RS and 2.5 mg of ampicillin trihydrate RS per ml. After removing the plate from the chromatographic chamber, allow it to dry in air until the

solvents have evaporated. Expose the plate to iodine vapours until the spots appear and examine the chromatogram in daylight.

The principal spot obtained with solution A corresponds in position, appearance, and intensity with that obtained with solution B. The test is valid only if the chromatogram obtained with solution C shows two clearly separated spots.

- C. Place about 2 mg in a test-tube (150 mm × 15 mm), moisten with 1 drop of water, and add about 2 ml of sulfuric acid (~1760 g/l) TS. Mix the contents of the tube by swirling; the solution remains practically colourless. Place the tube in a water-bath for 1 minute; a dark yellow colour develops.

Specific optical rotation. Use a 2.0 mg/ml solution in carbon-dioxide-free water R and calculate with reference to the anhydrous substance; $[\alpha]_D^{20} = +290^\circ$ to $+315^\circ$.

Solution in hydrochloric acid and ammonia. Prepare a solution of 1.0 g in 10 ml of hydrochloric acid (0.5 mol/l) VS. Prepare a second solution of 1.0 g in 10 ml of ammonia (~100 g/l) TS. Examine both solutions immediately.

Neither of these solutions are more opalescent than opalescence standard TS3.

Heavy metals. Use 1.0 g for the preparation of the test solution as described under “Limit test for heavy metals”, Procedure 3 (Vol. 1, p. 118); determine the heavy metals content according to Method A (Vol. 1, p. 119); not more than 20 µg/g.

Sulfated ash. Not more than 10 mg/g.

Water. Determine as described under “Determination of water by the Karl Fischer method”, Method A (Vol. 1, p. 135), using about 0.1 g of Amoxicillin trihydrate; the water content is not less than 0.115 g/g and not more than 0.145 g/g.

pH value. pH of a 2 mg/ml solution in carbon-dioxide-free water R, 3.5–5.5.

Related substances. Carry out the test as described under “High-performance liquid chromatography” (p. 264), using a stainless steel column (25 cm × 4.6 mm) packed with *stationary phase A* (5 µm). Prepare the following pH 5 buffer solution to be used in the mobile phases: to 250 ml of potassium dihydrogen phosphate (27.2 g/l) TS add sodium hydroxide (~80 g/l) TS until a pH of 5.0 is reached, and dilute the solution with sufficient water to produce 1000 ml. As mobile phase A use a mixture of 99 volumes of buffer solution pH 5.0 and 1 volume of acetonitrile R. As mobile phase B use a mixture of 8 volumes of buffer solution pH 5.0 and 2 volumes of acetonitrile R.

Prepare the following solutions in mobile phase A: solution (A) 1.5 mg of Amoxicillin trihydrate per ml; solution (B) 0.015 mg of amoxicillin trihydrate RS per ml; and solution (C) 0.15 µg of amoxicillin trihydrate RS per ml.

Operate with a flow rate of 1.0 ml per minute. As a detector use an ultraviolet spectrophotometer set at a wavelength of about 254 nm.

Using a 50-µl loop injector, inject solution B. Start the elution isocratically with the mobile phase mixture used for the equilibration. Immediately after elution of the amoxicillin peak start a linear gradient elution to reach a ratio of mobile phase A:B of 0:100 over a period of 25 minutes. Adjust the sensitivity of the system so that the height of the principal peak is at least 50% of the full scale of the recorder. Continue the chromatography with mobile phase B for 15 minutes, then equilibrate the column for 15 minutes with the mobile phase originally used for the equilibration. The mass distribution ratio for the first peak (amoxicillin) is 1.3–2.5. Inject mobile phase A using the 50-µl loop injector and use the same elution gradient to obtain a blank. Inject solution C using the 50-µl loop injector. Adjust the system to obtain a peak with a signal-to-noise ratio of at least 3.

Using the 50-µl loop injector, inject solution A. Measure the areas of the peak responses obtained in the chromatograms from solutions A and B, and calculate the content of the related substances as a percentage. In the chromatogram obtained with solution A, the area of any peak, other than the principal peak and any peak obtained in the blank chromatogram, is not greater than that of the principal peak obtained with solution B (1%).

Assay. Dissolve about 0.06 g, accurately weighed, in sufficient water to produce 500 ml. Simultaneously, prepare a reference solution containing 0.06 g of amoxicillin trihydrate RS. Transfer 10.0 ml of one solution to a 100-ml volumetric flask and 10.0 ml of the other solution to a second 100-ml volumetric flask. To each add 10 ml of buffer borate, pH 9.0, TS and 1 ml of acetic anhydride/dioxan TS, mix, allow to stand for 5 minutes at room temperature, and dilute to volume with water. Transfer two 2.0 ml aliquots of each solution to separate stoppered test-tubes. To one tube containing the test solution, and to the other, containing the reference solution, add 10 ml of imidazole/mercuric chloride TS, mix, stopper the tubes, and place them in a water-bath at 60 °C for exactly 25 minutes. Cool the tubes rapidly to 20 °C (*solution A*). To the remaining tubes add 10 ml of water and mix (*solution B*). Without delay, measure the absorbances of a 1-cm layer at the maximum at about 325 nm of both *solutions A*, using as a blank a mixture of 2.0 ml of water and 10 ml of imidazole/mercuric chloride TS placed in the solvent cell. For *solutions B* use water as a blank placed in the solvent cell.

From the difference between the absorbances of *solutions A* and *solutions B*, calculate the percentage content of $C_{16}H_{19}N_3O_5S$ by comparison with amoxicillin trihydrate RS, with reference to the anhydrous substance.

Atenololum

Atenolol

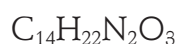
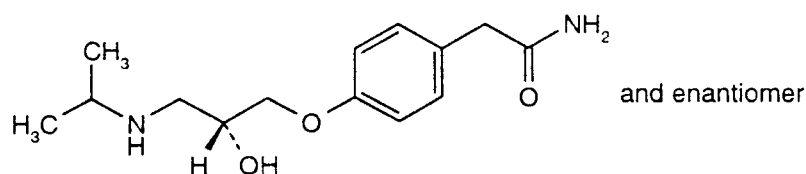

Relative molecular mass. 266.3

Chemical name. 2-[*p*-[2-Hydroxy-3-(isopropylamino)propoxy]phenyl]acetamide (racemate); CAS Reg. No. 29122-68-7.

Description. A white or almost white powder.

Solubility. Sparingly soluble in water; soluble in ethanol (~750 g/l) TS; slightly soluble in dichloromethane R.

Category. Cardiovascular agent; β -adrenoreceptor blocking agent.

Storage. Atenolol should be kept in a tightly closed container.

Requirements

Atenolol contains not less than **99.0%** and not more than **101.0%** of $C_{14}H_{22}N_2O_3$, calculated with reference to the dried substance.

Identity tests

- *Either tests A and D or tests B, C, and D may be applied.*

A. Carry out the examination as described under "Spectrophotometry in the infrared region" (Vol. 1, p. 40). The infrared absorption spectrum is concordant with the spectrum obtained from atenolol RS or with the *reference spectrum* of atenolol.

- B. The absorption spectrum of a 0.10 mg/ml solution in methanol R, when observed between 230 nm and 350 nm, exhibits 2 maxima at about 275 nm and 282 nm. The ratio of the absorbance at 275 nm to that at 282 nm is between 1.15 and 1.20.
- C. Carry out the test as described under “Thin-layer chromatography” (Vol. 1, p. 83), using silica gel R4 as the coating substance and a mixture of 99 volumes of methanol R and 1 volume of ammonia (~260 g/l) TS as the mobile phase. Apply separately to the plate 10 µl of each of 2 solutions in methanol R containing (A) 10 mg of Atenolol per ml, and (B) 10 mg of atenolol RS per ml. After removing the plate from the chromatographic chamber, allow it to dry in air, and examine the chromatogram in ultraviolet light (254 nm).

The principal spot obtained with solution A corresponds in position, appearance, and intensity with that obtained with solution B.

- D. Melting temperature, about 154 °C.

Chlorides. Dissolve 0.25 g in a mixture of 2 ml of nitric acid (~130 g/l) TS and 20 ml of water, and proceed as described under “Limit test for chlorides” (Vol. 1, p. 116); the chloride content is not more than 1.0 mg/g.

Sulfated ash. Not more than 1.0 mg/g.

Loss on drying. Dry to constant mass at 105 °C; it loses not more than 5.0 mg/g.

Related substances. Carry out the test as described under “High-performance liquid chromatography” (p. 264), using a stainless steel column (15 cm × 4.6 mm) packed with *stationary phase A* (5 µm). Prepare the following solution to be used as the mobile phase: dissolve 1.0 g of sodium octanesulfonate R and 0.4 g of tetrabutylammonium hydrogen sulfate R in 1000 ml of a mixture of 80 volumes of a 3.4 mg/ml solution of potassium dihydrogen phosphate R, the pH of the solution adjusted to 3.0 with phosphoric acid (~1440 g/l), 18 volumes of methanol R, and 2 volumes of tetrahydrofuran R.

Prepare the following solutions: for solution (A) dissolve 10 mg of Atenolol in 5 ml of mobile phase; for solution (B) dissolve 0.05 g of Atenolol in 0.10 ml of dimethyl sulfoxide R, if necessary applying gentle heat by placing the flask in a water-bath for a few seconds, and dilute with sufficient mobile phase to produce 25 ml; for solution (C) dilute 0.5 ml of solution A with sufficient mobile phase to produce 100 ml; and for solution (D) dissolve 0.05 g of atenolol for column validation RS in 0.10 ml of dimethyl sulfoxide R, if necessary applying gentle heat by placing the flask in a water-bath for a few seconds, and dilute with sufficient mobile phase to produce 25 ml.

Operate with a flow rate of 1.0 ml per minute. As a detector use an ultraviolet spectrophotometer set at a wavelength of about 226 nm.

Inject 10 µl of solution C. Adjust the sensitivity of the system so that the height of the principal peak is at least 50% of the full scale of the recorder.

Inject 10 µl of solution D. The tracing obtained is similar to that of the specimen chromatogram provided with atenolol for column validation RS, where the peak due to the bis-ether precedes and is separated from the tertiary amine which normally appears as a doublet. If necessary, adjust the concentration of sodium octanesulfonate R in the mobile phase: a higher concentration would increase the retention time of the tertiary amine.

Inject alternately 10 µl each of solutions A and C. Continue the recording of the chromatogram for four times the retention time of the principal peak.

Measure the areas of the peak responses obtained in the chromatograms from solutions A and C, and calculate the content of the related substances as a percentage. In the chromatogram obtained with solution A, the area of any peak, other than the principal peak, is not greater than half the area of the principal peak obtained with solution C (0.25%). The sum of the areas of all the peaks, other than the principal peak, is not greater than that of the principal peak obtained with solution C (0.5%). Disregard any peak with an area less than 0.1 times that of the principal peak obtained with solution C. If the content of bis-ether in Atenolol is greater than 0.15%, repeat the chromatography with 10 µl of solution B to confirm its compliance.

Assay. Dissolve about 0.2 g, accurately weighed, in 80 ml of glacial acetic acid R1, and titrate with perchloric acid (0.1 mol/l) VS as described under "Non-aqueous titration", Method A (Vol. 1, p. 131), determining the end-point potentiometrically.

Each ml of perchloric acid (0.1 mol/l) VS is equivalent to 26.63 mg of $C_{14}H_{22}N_2O_3$.

Benznidazolium

Benznidazole

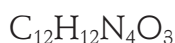
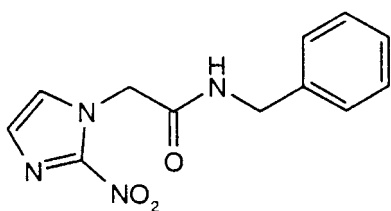

Relative molecular mass. 260.3

Chemical name. *N*-Benzyl-2-nitroimidazole-1-acetamide; *N*-benzyl-2-nitro-1-imidazole-acetamide; CAS Reg. No. 22994-85-0.

Description. A yellowish powder; odourless or almost odourless.

Solubility. Practically insoluble in water; sparingly soluble in acetone R; slightly soluble in methanol R; very slightly soluble in ethanol (~750 g/l) TS.

Category. Antiprotozoal drug.

Storage. Benznidazole should be kept in a well-closed container, protected from light.

Requirements

Benznidazole contains not less than **98.5%** and not more than the equivalent of **101.5%** of $C_{12}H_{12}N_4O_3$, calculated with reference to the dried substance.

Identity tests

- *Either test A alone or tests B and C may be applied.*
- A. Carry out the examination as described under “Spectrophotometry in the infrared region” (Vol. 1, p. 40). The infrared absorption spectrum is concordant with the spectrum obtained from benznidazole RS or with the *reference spectrum* of benznidazole.
- B. See the test described below under “Related substances”. The principal spot obtained with solution A corresponds in position, appearance, and intensity with that obtained with solution B.
- C. Melting temperature, about 190 °C.

Sulfated ash. Not more than 1.0 mg/g.

Loss on drying. Dry at 105 °C for 4 hours; it loses not more than 5.0 mg/g.

Related substances. Carry out the test as described under “Thin-layer chromatography” (Vol. 1, p. 83), using silica gel R2 as the coating substance and a mixture of 40 volumes of chloroform R, 40 volumes of ethyl acetate R, 15 volumes of methanol R, and 5 volumes of glacial acetic acid R as the mobile phase. Apply separately to the plate 20 µl of each of 3 solutions in acetone R containing (A) 25 mg of Benznidazole per ml, (B) 25 mg of benznidazole RS per ml, and (C) 125 µg of benznidazole RS per ml. After removing the plate from

the chromatographic chamber, allow it to dry in air until the solvents have evaporated, and heat at 110°C for 10 minutes. Allow it to cool and examine the chromatogram in ultraviolet light (254 nm).

Any spot obtained with solution A, other than the principal spot, is not more intense than that obtained with solution C (0.5%).

Assay. Dissolve about 0.2 g, accurately weighed, in 75 ml of acetic anhydride R, and titrate with perchloric acid (0.1 mol/l) VS as described under “Non-aqueous titration”, Method A (Vol. 1, p. 131), determining the end-point potentiometrically.

Each ml of perchloric acid (0.1 mol/l) VS is equivalent to 26.03 mg of $C_{12}H_{12}N_4O_3$.

Benzoylis peroxidum cum aqua

Hydrous Benzoyl peroxide

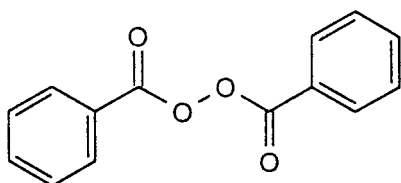

Relative molecular mass. 242.2 (anhydrous)

Chemical name. Dibenzoyl peroxide; CAS Reg. No. 94-36-0.

Description. A white, amorphous or granular powder.

Solubility. Practically insoluble in water; soluble in acetone R; soluble in dichloromethane R with separation of water; slightly soluble in ethanol (~750 g/l) TS.

Category. Keratolytic agent.

Storage. Hydrous Benzoyl peroxide should be kept in a container that has been treated to reduce static discharge and that has a device for the release of excess pressure. Store at a temperature between 2 and 8°C, protected from light.

Additional information. *CAUTION:* Hydrous Benzoyl peroxide may explode at temperatures higher than 60 °C or if its water content is too low. It may burst into flame in the presence of reducing substances. Unused material must not be returned to the original container but destroyed by treating with sodium hydroxide (~80 g/l) TS to a point where no iodine is liberated after acidifying with hydrochloric acid (~70 g/l) TS and adding a crystal of potassium iodide R.

Hydrous Benzoyl peroxide loses water rapidly on exposure to air. It must be handled with care, avoiding contact with the skin and mucous membranes and inhalation of airborne particles.

Requirements

Hydrous Benzoyl peroxide contains not less than **70.0%** and not more than **77.0%** of $C_{14}H_{10}O_4$, and not less than **20.0%** of water.

Note: Before carrying out any tests, thoroughly mix the entire sample.

Identity tests

- *Either test A alone or tests B, C, and D may be applied.*
- A. Carry out the examination as described under “Spectrophotometry in the infrared region” (Vol. 1, p. 40). The infrared absorption spectrum is concordant with the *reference spectrum* of benzoyl peroxide.
- B. Carry out the test as described under “Thin-layer chromatography” (Vol. 1, p. 83), using silica gel R4 as the coating substance and a mixture of 50 volumes of toluene R, 2 volumes of dichloromethane R, and 1 volume of glacial acetic acid R as the mobile phase. Apply separately to the plate 5 µl of each of 2 solutions in methanol R containing (A) 10.0 mg of Hydrous Benzoyl peroxide per ml, and (B) a solution of hydrous benzoyl peroxide R containing the equivalent of 10.0 mg of benzoyl peroxide per ml. After removing the plate from the chromatographic chamber, allow it to dry in air, and examine the chromatogram in ultraviolet light (254 nm).

The principal spot obtained with solution A corresponds in position, appearance, and intensity with that obtained with solution B.
- C. Dissolve about 25 mg in 2 ml of acetone R, add 1 ml of diethylphenylenediamine sulfate TS, and mix; a red colour is produced which turns rapidly to dark violet within 5 minutes.
- D. To 1 g add 5 ml of ethanol (~750 g/l) TS, 5 ml of sodium hydroxide (~80 g/l) TS, and 10 ml of water. Boil the mixture under a reflux condenser for 20 minutes and cool. To 1 ml of the resulting solution add 0.5 ml of ferric

chloride (65 g/l) TS; a dull yellow precipitate is produced which is soluble in ether R.

Chlorides. Dissolve a quantity containing the equivalent of 0.5 g of anhydrous Benzoyl peroxide in 15 ml of acetone R. Add, while stirring, 50 ml of nitric acid (0.05 mol/l) VS, allow to stand for 10 minutes, and filter. Wash the residue with two quantities, each of 10 ml, of nitric acid (0.05 mol/l) VS, combining the filtrate and the washings. Dilute this solution to 100 ml with nitric acid (0.05 mol/l) VS. Using 2.5 ml of this solution, proceed as described under "Limit test for chlorides" (Vol. 1, p. 116); the chloride content does not exceed 4 mg/g.

Water. Determine as described under "Determination of water by the Karl Fischer method", Method A (Vol. 1, p. 135), using 5.0 ml of solution A as prepared below under "Assay". Add 3 ml of a solution containing 0.10 g of potassium iodide R in dimethylformamide R. Stir for 5 minutes before starting the titration. Repeat the procedure using 5 ml of dimethylformamide R in place of solution A and make any necessary corrections. Calculate the content of water as a percentage.

Acidity. Dissolve a quantity containing the equivalent of 1.0 g of anhydrous Benzoyl peroxide in 25 ml of acetone R, add 75 ml of water, and filter. Wash the residue with two quantities of 10 ml of water. Combine the filtrate and washings, and titrate with sodium hydroxide (0.1 mol/l) VS, using 0.25 ml of phenolphthalein/ethanol TS as indicator, until the change in colour is observed. Repeat the procedure without the substance being examined. The difference between the titrations represents the amount of sodium hydroxide required; not more than 1.25 ml of sodium hydroxide (0.1 mol/l) VS.

Related substances. Carry out the test as described under "Thin-layer chromatography" (Vol. 1, p. 83), using silica gel R4 as the coating substance and a mixture of 40 volumes of light petroleum R1, 20 volumes of toluene R, 15 volumes of acetone R, and 1 volume of glacial acetic acid R as the mobile phase. Apply separately to the plate 5 µl of each of 4 freshly prepared solutions in acetone R containing (A) a quantity equivalent to 40 mg of anhydrous Benzoyl peroxide per ml, (B) 0.4 mg of anhydrous Benzoyl peroxide per ml, (C) 0.6 mg of benzoic acid R per ml, and for solution (D) mix 0.4 ml of benzyl benzoate R with 5 ml of acetone R and dilute to 10 ml with the same solvent. To 1.0 ml of this solution add 1.0 ml of solution A and dilute to 10 ml with acetone R. After removing the plate from the chromatographic chamber, allow it to dry in air for 20 minutes, and examine the chromatogram in ultraviolet light (254 nm).

Any spot corresponding to benzoic acid obtained with solution A is not more intense than that obtained with solution C (1.5%). Any spot obtained with solution A, other than the principal spot and the spot corresponding to benzoic

acid, is not more intense than that obtained with solution B (1%). The test is not valid unless the chromatogram obtained with solution D shows two clearly separated principal spots.

Assay. Immediately before testing dissolve 2.5 g in sufficient dimethylformamide R to produce 100 ml (*solution A*). To 5.0 ml of *solution A* add 20 ml of acetone R and 5 ml of potassium iodide (300 g/l) TS. Mix, allow to stand for 1 minute, and titrate with sodium thiosulfate (0.1 mol/l) VS until the solution is colourless. Repeat the procedure using 5 ml of dimethylformamide R in place of *solution A* and make any necessary corrections.

Each ml of sodium thiosulfate (0.1 mol/l) VS is equivalent to 12.11 mg of $C_{14}H_{10}O_4$.

Captoprilum

Captopril

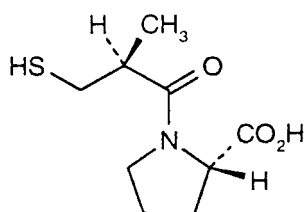

$C_9H_{15}NO_3S$

Relative molecular mass. 217.3

Chemical name. 1-[(2*S*)-3-Mercapto-2-methylpropionyl]-L-proline; 1-[(2*S*)-3-mercapto-2-methyl-1-oxopropyl]-L-proline; CAS Reg. No. 62571-86-2.

Description. A white or almost white, crystalline powder.

Solubility. Freely soluble in water, dichloromethane R, and methanol R.

Category. Cardiovascular agent; angiotensin-converting enzyme inhibitor.

Storage. Captopril should be kept in a tightly closed container, protected from light.

Additional information. Captopril may exist in different polymorphic forms.

Requirements

Captopril contains not less than **98.0%** and not more than **102.0%** of $C_9H_{15}NO_3S$, calculated with reference to the dried substance.

Identity tests

- *Either tests A and D or tests B, C, and D may be applied.*
- A. Carry out the examination as described under “Spectrophotometry in the infrared region” (Vol. 1, p. 40). The infrared absorption spectrum is concordant with the spectrum obtained from captopril RS or with the *reference spectrum* of captopril.
- B. Carry out the test as described under “Thin-layer chromatography” (Vol. 1, p. 83), using silica gel R4 as the coating substance and a mixture of 75 volumes of toluene R, 25 volumes of glacial acetic acid R, and 1 volume of methanol R as the mobile phase. Apply separately to the plate 2 μ l of each of 2 solutions in dichloromethane R containing (A) 5.0 mg of Captopril per ml, and (B) 5.0 mg of captopril RS per ml. After removing the plate from the chromatographic chamber, allow it to dry in air, and spray with 5,5'-dithiobis-2-nitrobenzoic acid/methanol TS. Examine the chromatogram in ultraviolet light (254 nm).

The principal spot obtained with solution A corresponds in position, appearance, and intensity with that obtained with solution B.

- C. Dissolve 25 mg in 2 ml of ethanol (~750 g/l) TS, add a few crystals of sodium nitrite R and 10 ml of sulfuric acid (~100 g/l) TS, and shake; a red colour is produced.
- D. Melting temperature, about 107 °C.

Specific optical rotation. Use a 10 mg/ml solution in dehydrated ethanol R and calculate with reference to the dried substance; $[\alpha]_D^{20} = -125^\circ$ to -134° .

Heavy metals. Use 1.0 g for the preparation of the test solution as described under “Limit test for heavy metals”, Procedure 3 (Vol. 1, p. 118); determine the heavy metals content according to Method A (Vol. 1, p. 119); not more than 20 μ g/g.

Sulfated ash. Not more than 2.0 mg/g.

Loss on drying. Dry at 60 °C under reduced pressure (not exceeding 0.6 kPa or about 5 mm of mercury) for 3 hours; it loses not more than 10 mg/g.

Related substances. Carry out the test as described under “High-performance liquid chromatography” (p. 257), using a stainless steel column (12.5 cm × 4 mm) packed with *stationary phase A* (5 μm). Prepare the following solution to be used as the mobile phase: mix 0.05 volumes of phosphoric acid (~1440 g/l) TS with 50 volumes of methanol R and 50 volumes of water.

Prepare the following solutions in the mobile phase: solution (A) 0.5 mg of Captopril per ml; solution (B) 10 μg of Captopril per ml; and for solution (C) dissolve 10 mg of Captopril in the mobile phase, add 1 ml of iodine (0.05 mol/l) VS, and dilute to 100 ml with the mobile phase; further dilute 10 ml of this solution to 100 ml with the mobile phase.

Operate with a flow rate of 1.0 ml per minute. As a detector use an ultraviolet spectrophotometer set at a wavelength of about 220 nm.

Inject 20 μl of solution B and adjust the sensitivity of the system so that the height of the principal peak is not less than 40% of the full scale of the recorder. Inject 20 μl of solution C. The test is not valid unless three peaks are obtained and the resolution between the last two eluting principal peaks is at least 2.0.

Inject alternately 20 μl each of solutions A and B. Continue the chromatography for three times the retention time of the principal peak obtained with solution A.

Measure the areas of the peak responses obtained in the chromatograms from solutions A and B, and calculate the content of the related substances as a percentage. In the chromatogram obtained with solution A, the area of any peak, other than the principal peak, is not greater than half the area of the principal peak obtained with solution B (1.0%). The sum of the areas of all the peaks, other than the principal peak, is not greater than the area of the peak obtained with solution A (2.0%). Disregard any peak with a retention time of less than 1.4 minutes or with an area less than 0.1 times that of the peak obtained with solution B.

Assay. Dissolve about 0.3 g, accurately weighed, in 100 ml of water, add 10 ml of sulfuric acid (~190 g/l) TS and 1 g of potassium iodide R. Mix and titrate with potassium iodate (0.01 mol/l) VS, using starch TS as indicator. Repeat the operation without the substance being examined. The difference between the titrations represents the amount of potassium iodate required.

Each ml of potassium iodate (0.01 mol/l) VS is equivalent to 13.04 mg of C₉H₁₅NO₃S.

Chlorali hydras

Chloral hydrate

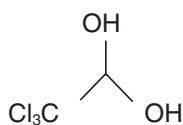

Relative molecular mass. 165.4

Chemical name. 2,2,2-Trichloroethane-1,1-diol; CAS Reg. No. 302-17-0.

Description. Colourless, transparent or white crystals; odour, aromatic, pungent and characteristic.

Solubility. Very soluble in water; freely soluble in ethanol (~750 g/l) TS and ether R.

Category. Premedication.

Storage. Chloral hydrate should be kept in a tightly closed container.

Additional information. Melting temperature, about 55 °C; when exposed to air it slowly volatilizes.

Requirements

Chloral hydrate contains not less than **98.5%** and not more than **101.0%** of $\text{C}_2\text{H}_3\text{Cl}_3\text{O}_2$.

Note: Prepare the following test solution for use in “Identity tests A and B”, and for “Clarity and colour”. Dissolve 2.5 g in sufficient carbon-dioxide-free water R to produce 25 ml.

Identity tests

- To 1.0 ml of the test solution add 2.0 ml of sodium sulfide TS; a yellow colour develops which quickly becomes reddish brown. On standing, a red precipitate may be produced.
- Transfer 10 ml of the test solution to a conical flask and add 10 ml of 1-ethylquinaldinium iodide (15 g/l) TS that has previously been filtered through a 0.45- μm filter. Then add 60 ml of 2-propanol R, 5 ml of monoethanolamine (0.1 mol/l) VS, and 15 ml of water. Mix, and heat in a water-bath at 60 °C for 15 minutes; a blue colour develops.

Chlorides. Dissolve 2.5 g in a mixture of 2 ml of nitric acid (~130 g/l) TS and 20 ml of water, and proceed as described under "Limit test for chlorides" (Vol. 1, p. 115); the chloride content is not more than 0.1 mg/g.

Chloral alcoholate. Warm 1.0 g with 10 ml of sodium hydroxide (~80 g/l) TS. Filter the upper layer and add iodine (0.05 mol/l) VS a drop at a time until a yellow colour is obtained; no precipitate is produced within 1 hour.

Clarity and colour of solution. The test solution is clear and colourless.

Sulfated ash. Not more than 1.0 mg/g.

pH value. pH of a 0.10 g/ml solution in carbon-dioxide-free water R, 3.5–5.5.

Assay. Dissolve about 4 g, accurately weighed, in 10 ml of carbon-dioxide-free water R and add 30.0 ml of carbonate-free sodium hydroxide (1 mol/l) VS. Allow the mixture to stand for 2 minutes and titrate with sulfuric acid (0.5 mol/l) VS, using phenolphthalein/ethanol TS as indicator. Repeat the procedure without the Chloral hydrate being examined and make any necessary corrections.

Each ml of carbonate-free sodium hydroxide (1 mol/l) VS is equivalent to 0.1654 g of $C_2H_3Cl_3O_2$.

Chloramphenicoli natrii succinas

Chloramphenicol sodium succinate

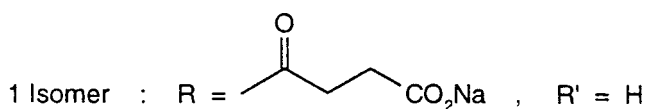
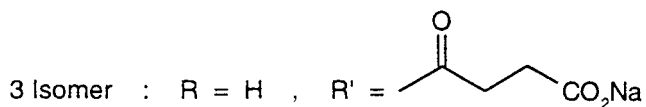
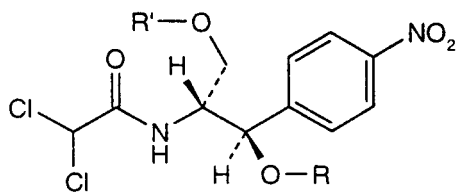

Relative molecular mass. 445.2

Chemical name. A mixture in variable proportions of (2*R*,3*R*)-2-(2,2-dichloroacetamido)-3-hydroxy-3-(4-nitrophenyl)propyl succinate (3 isomer) and of sodium (1*R*,2*R*)-2-(2,2-dichloroacetamido)-3-hydroxy-1-(4-nitrophenyl)propyl succinate (1 isomer); [*R*-(*R**,*R**)]-mono[2-[(2,2-dichloroacetyl)amino]-3-hydroxy-3-(4-nitrophenyl)propyl] ester, butanedioic acid, monosodium salt; *D*-*threo*-(-)-2,2-dichloro-*N*-[β-hydroxy-α-(hydroxymethyl)-*p*-nitrophenethyl]acetamide α-(sodium succinate); CAS Reg. No. 982-57-0.

Description. A white or yellowish white powder.

Solubility. Very soluble in water; freely soluble in ethanol (~750 g/l)TS.

Category. Antibacterial drug.

Storage. Chloramphenicol sodium succinate should be kept in a tightly closed container, protected from light.

Labelling. The designation Chloramphenicol sodium succinate for parenteral use indicates that the substance complies with the additional requirements and may be used for parenteral administration. Expiry date.

Additional information. Chloramphenicol sodium succinate is hygroscopic. Even in the absence of light, Chloramphenicol sodium succinate gradually degrades when exposed to a humid atmosphere; decomposition is more rapid at higher temperatures.

Requirements

Chloramphenicol sodium succinate contains not less than **98.0%** and not more than the equivalent of **102.0%** of $C_{15}H_{15}Cl_2N_2NaO_8$, calculated with reference to the anhydrous substance.

Identity tests

- A. Carry out the examination as described under "Spectrophotometry in the infrared region" (Vol. 1, p. 40). The infrared absorption spectrum is concordant with the spectrum obtained from chloramphenicol sodium succinate RS or with the *reference spectrum* of chloramphenicol sodium succinate.
- B. See the test described below under "Chloramphenicol and chloramphenicol disodium disuccinate, test B". The two principal spots obtained with solution A correspond in position and appearance with those obtained with solution B. The positions of the spots obtained with solutions A and B are different from that of the principal spot obtained with solution C.

- C. Dissolve 10 mg in 2.0 ml of ethanol (~750 g/l) TS, add 0.2 g of zinc R powder, 1.0 ml of sulfuric acid (~100 g/l) TS, and allow to stand for 10 minutes. Filter. To the filtrate add 0.5 ml of sodium nitrite (10 g/l) TS, and allow to stand for 2 minutes. Then add 1.0 g of urea R and a solution containing 10 mg of 2-naphthol R in 2 ml of sodium hydroxide (~80 g/l) TS; a red colour is produced. Repeat the test omitting the zinc R powder; no red colour is produced.
- D. Dissolve 5 mg in 5 ml of water and add a few drops of silver nitrate (40 g/l) TS; no precipitate is produced. Heat 0.05 g with 2.0 ml of potassium hydroxide/ethanol TS1 on a water-bath for 15 minutes, add 15 mg of charcoal R, shake, and filter. The filtrate yields reaction A described under "General identification tests" as characteristic of chlorides (Vol. 1, p. 112).
- E. When tested for sodium as described under "General identification tests" (Vol. 1, p. 115), it yields the characteristic reactions. If reaction B is to be used, prepare a 20 mg/ml solution.

Specific optical rotation. Use a 50 mg/ml solution and calculate with reference to the anhydrous substance; $[\alpha]_{\text{D}}^{20^{\circ}\text{C}} = +5.0^{\circ}$ to $+8.0^{\circ}$.

Clarity of solution. A solution of 1.0 g in 3.0 ml of carbon-dioxide-free water R is clear.

Water. Determine as described under "Determination of water by the Karl Fischer method", Method A (Vol. 1, p. 135), using about 0.5 g of Chloramphenicol sodium succinate; the water content is not more than 0.20 g/g.

pH value. pH of a 0.25 g/ml solution in carbon-dioxide-free water R, 6.4–7.0.

Chloramphenicol and chloramphenicol disodium disuccinate

- *Either test A or test B may be applied.*
- A. Carry out the test as described under "High-performance liquid chromatography" (p. 264), using a stainless steel column (25 cm × 4.6 mm) packed with *stationary phase A* (5 μm). As the mobile phase, use a mixture of 55 volumes of water, 40 volumes of methanol R, and 5 volumes of phosphoric acid (~20 g/l) TS.

Prepare the following solutions in the mobile phase: solution (A) 0.25 mg of Chloramphenicol sodium succinate per ml; solution (B) 5.0 μg of chloramphenicol RS per ml; solution (C) 5.0 μg of chloramphenicol disodium disuccinate RS per ml; and for solution (D) dissolve 25 mg of Chloramphenicol sodium succinate in the mobile phase, add 0.5 mg of chloramphenicol RS

and 0.5 mg of chloramphenicol disodium disuccinate RS and dilute to 100 ml with the mobile phase.

Operate with a flow rate of 1.0 ml per minute. As a detector use an ultraviolet spectrophotometer set at a wavelength of about 275 nm.

Using a 20- μ l loop injector inject solution D. Inject alternately solutions A, B, C, and D. The test is not valid unless the two peaks in the chromatogram obtained with solution D, corresponding to those in the chromatograms obtained with solutions B and C, are clearly separated from the peaks corresponding to the two principal peaks in the chromatogram obtained with solution A. If necessary, adjust the methanol content of the mobile phase.

Measure the areas of the peak responses obtained in the chromatograms from solutions A, B, and C, and calculate the content of the related substances as a percentage. In the chromatogram obtained with solution A, the area of any peak corresponding to chloramphenicol is not greater than that of the principal peak obtained with solution B (2.0%). The area of any peak corresponding to chloramphenicol disodium disuccinate is not greater than that of the principal peak obtained with solution C (2.0%).

- B. Carry out the test as described under "Thin-layer chromatography" (Vol. 1, p. 83), using silica gel R4 as the coating substance and a mixture of 85 volumes of dichloromethane R, 14 volumes of methanol R, and 1 volume of acetic acid (~60 g/l) TS as the mobile phase. Apply separately to the plate 2 μ l of each of 3 solutions in acetone R containing (A) 10 mg of Chloramphenicol sodium succinate per ml, (B) 10 mg of chloramphenicol sodium succinate RS per ml, and (C) 10 mg of chloramphenicol RS per ml. Then apply separately 10 μ l of solution (A) as prepared above and 1 μ l of solution (D) containing 0.20 mg of chloramphenicol RS per ml of acetone R. After removing the plate from the chromatographic chamber, allow it to dry in air until the solvents have evaporated, and examine the chromatogram in ultraviolet light (254 nm).

Any spot obtained with the second application of solution A, other than the principal spot, is not more intense than that obtained with solution D (2.0%).

Assay. Dissolve about 0.2 g, accurately weighed, in sufficient water to produce 500 ml; dilute 5.0 ml of this solution to 100 ml with water. Measure the absorbance of the diluted solution in a 1-cm layer at the maximum at about 276 nm and calculate the percentage content of $C_{15}H_{15}Cl_2N_2NaO_8$ using the absorptivity value of 22.0 ($A_{1\text{cm}}^{1\%} = 220$), and with reference to the anhydrous substance.

Additional requirements for Chloramphenicol sodium succinate for parenteral use

Complies with the monograph for "Parenteral preparations" (see Vol. 4, p. 36).

Storage. Sterile Chloramphenicol sodium succinate should be kept in a sterile, tightly closed, and tamper-proof container, protected from light.

Bacterial endotoxins. Carry out the test as described under "Test for bacterial endotoxins" (p. 30); contains not more than 0.2 IU of endotoxin RS per mg.

Sterility. Complies with the "Sterility testing of antibiotics", Membrane filtration test procedure (Vol. 1, p. 152).

Ciclosporinum

Ciclosporin

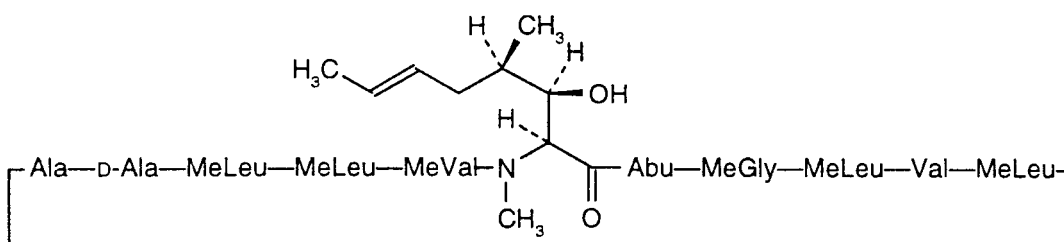

Relative molecular mass. 1203

Chemical name. Cyclo[[*(E)*-(2*S*,3*R*,4*R*)-3-hydroxy-4-methyl-2-(methylamino)-6-octenoyl]-L-2-aminobutyryl-*N*-methylglycyl-*N*-methyl-L-leucyl-L-valyl-*N*-methyl-L-leucyl-L-alanyl-D-alanyl-*N*-methyl-L-leucyl-*N*-methyl-L-leucyl-*N*-methyl-L-valyl]; cyclosporin A; CAS Reg. No. 59865-13-3.

Other name. Cyclosporin.

Description. A white or almost white powder.

Solubility. Practically insoluble in water; freely soluble in ethanol (~750 g/l) TS and dichloromethane R.

Category. Immunosuppressant drug.

Storage. Ciclosporin should be kept in a well-closed container, protected from light.

Requirements

Ciclosporin contains not less than **98.5%** and not more than **101.5%** of $C_{62}H_{111}N_{11}O_{12}$, calculated with reference to the dried substance.

Identity tests

- *Either test A alone or tests B and C may be applied.*
- A. Carry out the examination as described under “Spectrophotometry in the infrared region” (Vol. 1, p. 40). The infrared absorption spectrum is concordant with the spectrum obtained from ciclosporin RS or with the *reference spectrum* of ciclosporin.
- B. See the test described below under “Related substances” and under “Assay”. The principal peak obtained with solution A corresponds in retention time to that obtained with solution B.
- C. Dissolve 5 mg in 5 ml of methanol R, and 1 drop of potassium permanganate (10 g/l) TS, and allow to stand; the blue-red colour is gradually discharged.

Specific optical rotation. Use a 5.0 mg/ml solution in methanol R and calculate with reference to the dried substance; $[\alpha]_D^{20} = -185^\circ$ to -193° .

Heavy metals. Use 1.0 g for the preparation of the test solution as described under “Limit test for heavy metals”, Procedure 3 (Vol. 1, p. 118); determine the heavy metals content according to Method A (Vol. 1, p. 119); not more than 20 µg/g.

Clarity and colour of solution in ethanol. A solution of 1.0 g in 10 ml of ethanol (~750 g/l) TS is clear and not more intensely coloured than standard colour solution Yw3 or Rd1 when compared as described under “Colour of liquids” (Vol. 1, p. 50).

Sulfated ash. Not more than 1.0 mg/g.

Loss on drying. Dry at 60 °C under reduced pressure (not exceeding 0.6 kPa or about 5 mm of mercury) for 3 hours; it loses not more than 20 mg/g.

Related substances. Carry out the test as described below under “Assay”.

Inject alternately 20 µl each of solutions A and C. Continue the recording of the chromatogram for 1.7 times the retention time of the principal peak.

Measure the areas of the peak responses obtained in the chromatograms from solutions A and C, and calculate the content of the related substances as a percentage. In the chromatogram obtained with solution A, the area of any peak, other than the principal peak, is not greater than 0.7 times the area of the principal peak obtained with solution C (0.7%), and the sum of these areas is not greater than 1.5 times the area of the principal peak of the chromatogram obtained with solution C (1.5%).

Assay. Determine as described under “High-performance liquid chromatography” (p. 257), using a stainless steel column (25 cm × 4 mm) packed with *stationary phase A* (3–5 µm). The column is connected to the injection port by a steel capillary tube about 1 m long with an internal diameter of 0.25 mm. Maintain the temperature of the column and of the steel capillary at 80 °C. As the mobile phase, use a mixture of 52 volumes of water, 43 volumes of acetonitrile R, 5 volumes of *tert*-butyl methyl ether R, and 0.1 volume of phosphoric acid (~1440 g/l) TS.

Prepare the following solutions in a solvent mixture of equal volumes of acetonitrile R and water: solution (A) 1.2 mg of Ciclosporin per ml; solution (B) 1.2 mg of ciclosporin RS per ml; for solution (C) dilute 2.0 ml of solution B to 200 ml with the solvent mixture; and for solution (D) dissolve 3 mg of ciclosporin U RS in 2.5 ml of the solvent mixture and add 2.5 ml of solution B.

Operate with a flow rate of about 1.5 ml per minute. As a detector use an ultraviolet spectrophotometer set at a wavelength of about 210 nm.

Inject 20 µl of solution D. The assay is valid only if the relative standard deviation of the area of the principal peak is not more than 1.0%, unless the resolution between the two principal peaks is 1.0 and 1.8. The assay is not valid unless the retention time of the principal peak is between 25 and 30 minutes.

Inject alternately 20 µl each of solutions A and B.

Measure the areas of the peak responses obtained in the chromatograms from solutions A and B, and calculate the percentage content of C₆₂H₁₁₁N₁₁O₁₂.

Ciprofloxacini hydrochloridum

Ciprofloxacin hydrochloride

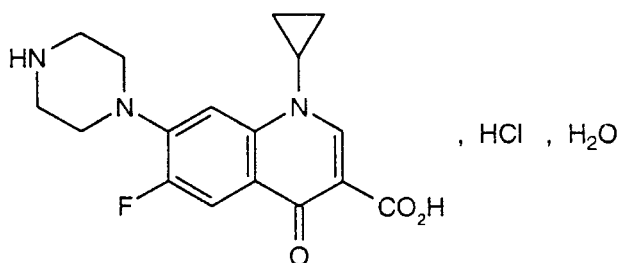

$C_{17}H_{18}FN_3O_3, HCl, H_2O$

Relative molecular mass. 385.8

Chemical name. 1-Cyclopropyl-6-fluoro-1,4-dihydro-4-oxo-7-(1-piperazinyl)-3-quinolinecarboxylic acid monohydrochloride monohydrate; CAS Reg. No. 86393-32-0.

Description. A pale yellow, crystalline powder.

Solubility. Soluble in water; slightly soluble in methanol R; very slightly soluble in ethanol (~750 g/l) TS; practically insoluble in acetone R and dichloromethane R.

Category. Antibacterial.

Storage. Ciprofloxacin hydrochloride should be kept in a tightly closed container, protected from light.

Requirements

Ciprofloxacin hydrochloride contains not less than **98.0%** and not more than **102.0%** of $C_{17}H_{18}FN_3O_3, HCl$, calculated with reference to the anhydrous substance.

Identity tests

- A. Carry out the examination as described under “Spectrophotometry in the infrared region” (Vol. 1, p. 40). The infrared absorption spectrum is concordant with the spectrum obtained from ciprofloxacin hydrochloride RS or with the *reference spectrum* of ciprofloxacin hydrochloride.
- B. Carry out the test as described under “Thin-layer chromatography” (Vol. 1, p. 83), using silica gel R4 as the coating substance and a mixture of 4 volumes

of methanol R, 4 volumes of dichloromethane R, 2 volumes of ammonia (~260 g/l) TS, and 1 volume of acetonitrile R as the mobile phase. Apply separately to the plate as 1-cm bands, 5 µl of each of 2 solutions containing (A) 10 mg of Ciprofloxacin hydrochloride per ml, and (B) 10 mg of ciprofloxacin hydrochloride RS per ml. Place an evaporating-dish containing 50 ml of ammonia (~260 g/l) TS in the chromatographic chamber. Expose the plate to the ammonia vapour in the closed chamber for 15 minutes. Withdraw the plate and transfer to another chromatographic chamber containing the mobile phase to develop. After removing the plate from the chromatographic chamber, allow it to dry in air for about 15 minutes, and examine the chromatogram in ultraviolet light (254 nm and 365 nm).

The principal spot obtained with solution A corresponds in position, appearance, and intensity with that obtained with solution B.

C. A 0.1 g/ml solution yields reaction B described under “General identification tests” as characteristic of chlorides (Vol. 1, p. 112).

Heavy metals. For the preparation of the test solution dissolve 0.25 g in water and dilute to 30 ml with the same solvent. Carry out the prefiltration. Determine the heavy metals content in the filtrate as described under “Limit test for heavy metals”, Method B (Vol. 1, p. 119); not more than 20 µg/g.

Clarity and colour of solution. A solution of 0.25 g in 10 ml of carbon-dioxide-free water R is clear and not more intensely coloured than standard colour solution Gn4 when compared as described under “Colour of liquids” (Vol. 1, p. 50).

Sulfated ash. Not more than 1.0 mg/g.

Water. Determine as described under “Determination of water by the Karl Fischer method”, Method B (Vol. 1, p. 135), using about 0.2 g of the substance; the water content is between 0.047 g/g and 0.067 g/g.

pH value. pH of a 25 mg/ml solution in carbon-dioxide-free water R, 3.0–4.5.

Fluoroquinolonic acid. Carry out the test as described under “Thin-layer chromatography” (Vol. 1, p. 83), using silica gel R4 as the coating substance and a mixture of 4 volumes of methanol R, 4 volumes of dichloromethane R, 2 volumes of ammonia (~260 g/l) TS, and 1 volume of acetonitrile R as the mobile phase. Apply separately to the plate 5 µl of each of 2 solutions containing (A) 10 mg of Ciprofloxacin hydrochloride per ml, and for solution (B) dissolve 10 mg of fluoroquinolonic acid RS in a mixture of 0.10 ml of ammonia (~100 g/l) TS and 90 ml of water, and dilute to 100 ml with water. Dilute 2.0 ml of this solution to 10 ml with water. Place an evaporating-dish containing 50 ml

of ammonia (~260 g/l) TS in the chromatographic chamber. Expose the plate to the ammonia vapour in the closed chamber for 15 minutes. Withdraw the plate and transfer to another chromatographic chamber containing the mobile phase to develop. After removing the plate from the chromatographic chamber, allow it to dry in air for about 15 minutes, and examine the chromatogram in ultraviolet light (254 nm).

The spot corresponding to fluoroquinolonic acid in the chromatogram obtained with solution A is not more intense than that obtained with solution B (0.2%).

Related substances. Carry out the test as described below under “Assay”.

Inject 50 µl each of solutions A and F. Record the chromatogram for twice the retention time of ciprofloxacin.

Measure the areas of the peak responses obtained in the chromatograms from solutions A and F, and calculate the content of the related substances as a percentage. In the chromatogram obtained with solution A, the areas of the peaks corresponding to the ethylenediamine compound and the by-compound A are not greater than the corresponding peaks in the chromatogram obtained with solution F (0.2%); the area of any other peak is not greater than the area of the peak corresponding to the ethylenediamine compound in the chromatogram obtained with solution F (0.2%); the sum of the areas of all the peaks, other than the principal peak, is not greater than 2.5 times the area of the peak corresponding to the ethylenediamine compound in the chromatogram obtained with solution F (0.5%). Disregard any peak with an area less than 0.25 times the area of the peak corresponding to the ethylenediamine compound in the chromatogram obtained with solution F (0.05%).

Assay. Determine as described under “High-performance liquid chromatography” (p. 257), using a stainless steel column (25 cm × 4.6 mm) packed with *stationary phase A* (5 µm). As the mobile phase, use a mixture of 87 volumes of phosphoric acid (~2.45 g/l) TS, adjusted to a pH of 3.0 with triethylamine R and 13 volumes of acetonitrile R.

Prepare the following solutions in the mobile phase to produce 50 ml: solution (A) contains 0.50 mg of Ciprofloxacin hydrochloride per ml; solution (B) contains 0.50 mg of ciprofloxacin hydrochloride RS per ml; solution (C) contains 0.050 mg of 1-cyclopropyl-1,4-dihydro-4-oxo-7-(1-piperazin-1-yl)quinoline-3-carboxylic acid RS per ml (desfluoro compound); solution (D) contains 0.050 mg of 7-[(2-aminoethyl)amino]-1-cyclopropyl-6-fluoro-1,4-dihydro-4-oxo-quinoline-3-carboxylic acid RS (ethylenediamine compound) per ml; solution (E) contains 0.050 mg of 7-chloro-1-cyclopropyl-1,4-dihydro-4-oxo-6-(piperazin-1-yl)quinoline-3-carboxylic acid RS (by-compound A) per ml. For solution (F) mix 0.1 ml of solution A with 1.0 ml of solution C, 1.0 ml of solution D, 1.0 ml of solution E, and dilute to 50 ml with the mobile phase.

Operate with a flow rate of 1.5 ml per minute. As a detector use an ultraviolet spectrophotometer set at a wavelength of about 278 nm. Maintain the temperature of the column at 40 °C.

Inject 50 µl of solution F. The following order of elution is obtained: desfluoro compound, ethylenediamine compound, ciprofloxacin and by-compound A. The retention time of ciprofloxacin is about 9 minutes. Adjust the sensitivity of the system so that the height of the peak due to the ethylenediamine compound is at least 40% of the full scale of the recorder. The assay is not valid unless the resolution between the peaks corresponding to the desfluoro compound and the ethylenediamine compound is at least 1.3, and the resolution between the peaks corresponding to ciprofloxacin and the by-compound A is at least 3.0. Inject 10 µl of solution B. The assay is not valid unless the relative standard deviation of the peak area of ciprofloxacin is at most 1.0%.

Inject alternately 10 µl each of solutions A and B.

Measure the areas of the peak responses obtained in the chromatograms from solutions A and B, and calculate the percentage content of $C_{17}H_{18}FN_3O_3 \cdot HCl$.

Ciprofloxacinum

Ciprofloxacin

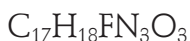
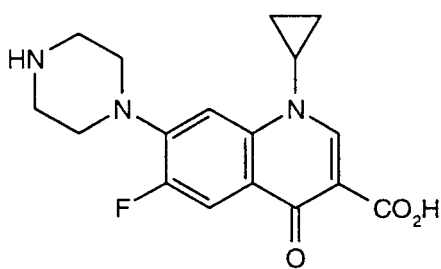

Relative molecular mass. 331.4

Chemical name. 1-Cyclopropyl-6-fluoro-1,4-dihydro-4-oxo-7-(1-piperazinyl)-3-quinolinecarboxylic acid; CAS Reg. No. 85721-33-1.

Description. A white to pale yellow, crystalline powder.

Solubility. Practically insoluble in water; very slightly soluble in ethanol (~750 g/l) TS and dichloromethane R.

Category. Antibacterial.

Storage. Ciprofloxacin should be kept in a well-closed container, protected from light.

Additional information. Ciprofloxacin exists in different polymorphic forms.

Requirements

Ciprofloxacin contains not less than **98.0%** and not more than **102.0%** of $C_{17}H_{18}FN_3O_3$, calculated with reference to the dried substance.

Identity test

Carry out the examination as described under "Spectrophotometry in the infrared region" (Vol. 1, p. 40). The infrared absorption spectrum is concordant with the spectrum obtained from ciprofloxacin RS or with the *reference spectrum* of ciprofloxacin.

Heavy metals. For the preparation of the test solution dissolve 0.5 g in acetic acid (~60 g/l) TS and dilute to 30 ml with the same solvent. Carry out the pre-filtration. To the filtrate add 2.0 ml of water and determine the heavy metals content as described under "Limit test for heavy metals", Method B (Vol. 1, p. 119); not more than 20 µg/g.

Clarity and colour of solution. A solution of 0.25 g in 20 ml of hydrochloric acid (0.1 mol/l) VS is clear and not more intensely coloured than standard colour solution Gn4 when compared as described under "Colour of liquids" (Vol. 1, p. 50).

Sulfated ash. Not more than 1.0 mg/g.

Loss on drying. Dry to constant mass at 120 °C under reduced pressure (not exceeding 0.6 kPa or 5 mm of mercury); it loses not more than 10 mg/g.

Fluoroquinolonic acid. Carry out the test as described under "Thin-layer chromatography" (Vol. 1, p. 83), using silica gel R4 as the coating substance and a mixture of 4 volumes of methanol R, 4 volumes of dichloromethane R, 2 volumes of ammonia (~260 g/l) TS, and 1 volume of acetonitrile R as the mobile phase. Apply separately to the plate 5 µl of each of 2 solutions containing (A) 10 mg of Ciprofloxacin per ml of acetic acid (~60 g/l) TS, and for solution (B) dissolve 10 mg of fluoroquinolonic acid RS in a mixture of 0.10 ml of ammonia (~100 g/l) TS and 90 ml of water, and dilute to 100 ml with water. Dilute 2.0 ml of this solution to 10 ml with water. Place an evaporating-dish containing 50 ml of ammonia (~260 g/l) TS in the chromatographic chamber. Expose the plate to the ammonia vapour in the closed chamber for 15 minutes. Withdraw the plate and transfer to another chromatographic chamber containing the mobile phase

to develop. After removing the plate from the chromatographic chamber, allow it to dry in air for about 15 minutes, and examine the chromatogram in ultraviolet light (254 nm).

The spot corresponding to fluoroquinolonic acid in the chromatogram obtained with solution A is not more intense than that obtained with solution B (0.2%).

Related substances. Carry out the test as described under “High-performance liquid chromatography” (p. 257), using a stainless steel column (25 cm × 4.6 mm) packed with base-deactivated *stationary phase A* (5 μm). As the mobile phase, use a mixture of 87 volumes of phosphoric acid (~2.8 g/l) TS adjusted to a pH of 3.0 with triethylamine R and 13 volumes of acetonitrile R.

Prepare the following solutions in the mobile phase. For solution (A) add 0.2 ml of phosphoric acid (~105 g/l) TS to 25 mg of Ciprofloxacin, dilute to 50 ml, and treat in an ultrasonic bath until a clear solution is obtained. For solution (B) dilute 0.10 ml of solution A to 50 ml. For solution (C) use 2.5 mg of 1-cyclopropyl-1,4-dihydro-4-oxo-7-(piperazin-1-yl)quinoline-3-carboxylic acid RS (desfluoro compound) and dilute to 50 ml (this solution is also used to prepare solution F), further dilute 1.0 ml of this solution to 50 ml with the mobile phase. For solution (D) use 2.5 mg of 7-[(2-aminoethyl)amino]-1-cyclopropyl-6-fluoro-1,4-dihydro-4-oxo-quinoline-3-carboxylic acid RS (ethylenediamine compound) and dilute to 50 ml (this solution is also used to prepare solution F), further dilute 1.0 ml of this solution to 50 ml with the mobile phase. For solution (E) use 2.5 mg of 7-chloro-1-cyclopropyl-1,4-dihydro-4-oxo-6-(piperazin-1-yl)quinoline-3-carboxylic acid RS (by-compound A) and dilute to 50 ml (this solution is also used to prepare solution F), further dilute 1.0 ml of this solution to 50 ml with the mobile phase. For solution (F) mix 0.1 ml of solution A with 1.0 ml of each of solutions C, D, and E, prior to dilution as described above, and dilute to 50 ml.

Operate with a flow rate of 1.5 ml per minute. As a detector use an ultraviolet spectrophotometer set at a wavelength of about 278 nm. Maintain the temperature of the column at 40 °C.

Inject alternately 50 μl each of solutions B, C, D, E, and F. The retention time of ciprofloxacin is about 9 minutes. Adjust the sensitivity of the system so that the height of the peak due to the ethylenediamine compound obtained with solution F is at least 40% of the full scale of the recorder. The test is not valid unless the resolution between the peaks corresponding to the desfluoro compound and the ethylenediamine compound in the chromatogram obtained with solution F is at least 1.3, and the resolution between the peaks corresponding to ciprofloxacin and the by-compound A is at least 3.0.

Inject alternately 50 μl each of solutions A, D, and E. Record the chromatogram for twice the retention time of ciprofloxacin.

Measure the areas of the peak responses obtained in the chromatograms from solutions A, D, and E, and calculate the content of the related substances as a percentage. In the chromatogram obtained with solution A, the areas of the peaks corresponding to the ethylenediamine compound and by-compound A are not greater than the corresponding peaks obtained with solutions D and E (0.2%). The area of any other peak is not greater than the area of the peak obtained with solution D (0.2%). The sum of the areas of all the peaks, other than the principal peak, is not greater than 2.5 times the area of the peak in the chromatogram obtained with solution D (0.5%). Disregard any peak with an area less than 0.25 times the area of the peak obtained with solution D (0.05%).

Assay. Dissolve about 0.3g, accurately weighed, in 80ml of glacial acetic acid R1, and titrate with perchloric acid (0.1mol/l) VS as described under "Non-aqueous titration", Method A (Vol. 1, p. 131), determining the end-point potentiometrically.

Each ml of perchloric acid (0.1mol/l) VS is equivalent to 33.14mg of $C_{17}H_{18}FN_3O_3$.

Clindamycini phosphas

Clindamycin phosphate

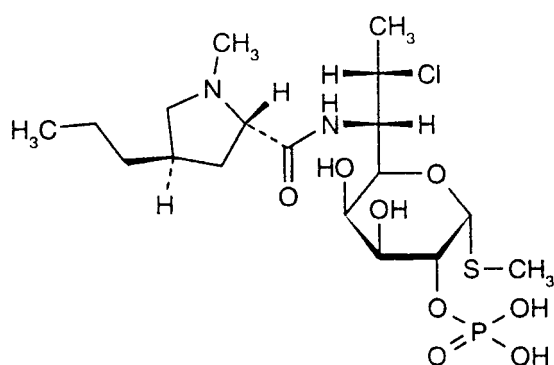

Relative molecular mass. 505.0

Chemical name. (2*S*-*trans*)-Methyl 7-chloro-6,7,8-trideoxy-6-(1-methyl-*trans*-4-propyl-L-2-pyrrolidinecarboxamido)-1-thio-L-*threo*-α-D-*galacto*-octopyranoside 2-(dihydrogen phosphate); CAS Reg. No. 24729-96-2.

Description. A white or almost white, crystalline powder.

Solubility. Freely soluble in water; very slightly soluble in ethanol (~750 g/l) TS and acetone R.

Category. Antibacterial drug.

Storage. Clindamycin phosphate should be kept in a tightly closed container and stored at a temperature not exceeding 30 °C.

Labelling. The designation Clindamycin phosphate for parenteral use indicates that the substance complies with the additional requirements and may be used for parenteral administration. Expiry date.

Additional information. Clindamycin phosphate is slightly hygroscopic.

Requirements

Clindamycin phosphate contains not less than **95.0%** and not more than **100.5%** of $C_{18}H_{34}ClN_2O_8PS$, calculated with reference to the anhydrous substance.

Identity tests

- *Either tests A and D or tests B, C, and D may be applied.*
- A. Carry out the examination as described under “Spectrophotometry in the infrared region” (Vol. 1, p. 40). The infrared absorption spectrum is concordant with the spectrum obtained from clindamycin phosphate RS or with the *reference spectrum* of clindamycin phosphate.
- B. Carry out the test as described under “Thin-layer chromatography” (Vol. 1, p. 83), using silica gel R3 as the coating substance and a mixture of 6 volumes of 1-butanol R, 2 volumes of water, and 2 volumes of glacial acetic acid R as the mobile phase. Apply separately to the plate 5 µl of each of 3 solutions in methanol R containing (A) 2.0 mg of Clindamycin phosphate per ml, (B) 2.0 mg of clindamycin phosphate RS, and for solution (C) dissolve 10 mg of lincomycin hydrochloride RS in 5 ml of solution B. After removing the plate from the chromatographic chamber, allow it to dry at 105 °C for 30 minutes, and spray with potassium permanganate (1 g/l) TS. Examine the chromatogram in daylight.

The principal spot obtained with solution A corresponds in position, appearance, and intensity to that obtained with solution B. The test is not valid unless the chromatogram obtained with solution C shows two clearly separated spots.

- C. Dissolve 10 mg in 2 ml of hydrochloric acid (~70 g/l) TS and heat directly in a flame for 1 minute; a disagreeable sulfurous odour is perceptible. Cool,

add 4 ml of sodium carbonate (75 g/l) TS and 0.5 ml of sodium nitroprusside (45 g/l) TS; a violet-red ring is formed that fades quickly.

D. Boil 0.1 g under a reflux condenser with a mixture of 5 ml of sodium hydroxide (~400 g/l) TS and 5 ml of water for 90 minutes. Cool and add 5 ml of nitric acid (~1000 g/l) TS. Extract with three 15-ml quantities of dichloromethane R, and discard the extracts. Filter the aqueous layer through a paper filter; the filtrate yields reaction B described under “General identification tests” as characteristic of orthophosphates (Vol. 1, p. 114).

Specific optical rotation. Use a 10 mg/ml solution and calculate with reference to the anhydrous substance; $[\alpha]_{\text{D}}^{20\text{ }^{\circ}\text{C}} = +115^{\circ}$ to $+130^{\circ}$.

Clarity and colour of solution. A solution of 0.040 g in 10 ml of carbon-dioxide-free water R is clear and colourless.

Water. Determine as described under “Determination of water by the Karl Fischer method”, Method A (Vol. 1, p. 135), using 0.5 g of the substance; the water content is not more than 0.060 g/g.

pH value. pH of a 10 mg/ml solution in carbon-dioxide-free water R, 3.5–4.5.

Related substances. Carry out the test as described below under “Assay”.

Inject alternately 20 μl each of solutions A and D. Continue the recording of the chromatogram until clindamycin is eluted.

Measure the areas of the peak responses obtained in the chromatograms from solutions A and D, and calculate the content of the related substances as a percentage. In the chromatogram obtained with solution A, the area of any peak, other than the principal peak or any peak corresponding to the solvent, is not greater than 2.5 times the area of the principal peak obtained with solution D (2.5%). The sum of the areas of all the peaks, other than the principal peak or any peak corresponding to the solvent, is not greater than 4 times the peak corresponding to clindamycin phosphate obtained with solution D (4.0%).

Assay. Determine as described under “High-performance liquid chromatography” (p. 257), using a stainless steel column (25 cm \times 4.6 mm) packed with *stationary phase A* (5–10 μm). As the mobile phase, use a mixture of 8 volumes of potassium dihydrogen phosphate (13.6 g/l) TS adjusted to pH 2.5 with phosphoric acid (~105 g/l) TS and 2 volumes of acetonitrile R.

Prepare the following solutions in the mobile phase: solution (A) 3.0 mg of Clindamycin phosphate per ml; solution (B) 3.0 mg of clindamycin phosphate RS per ml; for solution (C) dissolve 5 mg of lincomycin hydrochloride RS and 15.0 mg of clindamycin hydrochloride RS in 5.0 ml of solution B and dilute with

sufficient mobile phase to produce 100 ml; and for solution (D) dilute 1.0 ml of solution B with sufficient mobile phase to produce 100 ml.

Operate with a flow rate of 1.0 ml per minute. As a detector use an ultraviolet spectrophotometer set at a wavelength of about 210 nm.

Inject 20 µl of solution C.

The assay is not valid unless the first peak (lincomycin) is clearly separated from the solvent peak, and the resolution between the second peak (clindamycin phosphate) and the third peak (clindamycin) is at least 6.0. The assay is valid only if the symmetry factor of the clindamycin phosphate peak is not greater than 1.5.

Inject 20 µl of solution B. If necessary adjust the integrator parameters.

Inject alternately 20 µl each of solutions A and B.

Measure the areas of the peak responses obtained with solutions A and B, and calculate the percentage content of $C_{18}H_{34}ClN_2O_8PS$.

Additional requirements for Clindamycin phosphate for parenteral use

Complies with the monograph for "Parenteral preparations" (see Vol. 4, p. 36).

Bacterial endotoxins. Carry out the test as described under "Test for bacterial endotoxins" (p. 30); contains not more than 0.6 IU of endotoxin RS per mg of clindamycin.

Sterility. Complies with the "Sterility testing of antibiotics" (Vol. 1, p. 152), applying the membrane filtration test procedure and using a solution in water containing 150 mg of Clindamycin phosphate per ml.

Dacarbazine

Dacarbazine

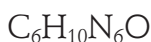
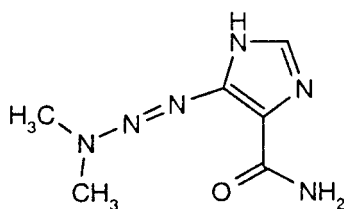

Relative molecular mass. 182.2

Chemical name. 5-(3,3-Dimethyl-1-triazeno)imidazole-4-carboxamide; 5-(3,3-dimethyl-1-triazenyl)-1*H*-imidazole-4-carboxamide; CAS Reg. No. 4342-03-4.

Description. A colourless or pale yellow, crystalline powder.

Solubility. Slightly soluble in water and ethanol (~750 g/l) TS.

Category. Cytotoxic drug.

Storage. Dacarbazine should be kept in a tightly closed container, protected from light, and stored at a temperature not exceeding 8 °C.

Additional information. *CAUTION:* Dacarbazine must be handled with care, avoiding contact with the skin and inhalation of airborne particles.

Requirements

Dacarbazine contains not less than **97.0%** and not more than **102.0%** of C₆H₁₀N₆O, calculated with reference to the dried substance.

Identity tests

- *Either test A alone or tests B, C, and D may be applied.*
- A. Carry out the examination as described under “Spectrophotometry in the infrared region” (Vol. 1, p. 40). The infrared absorption spectrum is concordant with the spectrum obtained from dacarbazine RS or with the *reference spectrum* of dacarbazine.
- B. The absorption spectrum of a 6 µg/ml solution in hydrochloric acid (0.1 mol/l) VS, when observed between 230 nm and 350 nm, exhibits a maximum at about 323 nm and a pronounced shoulder at 275 nm. The absorbance of a 1-cm layer at the maximum wavelength of 323 nm is about 0.64.
- C. Dissolve 25 mg in 5 ml of water, add 1 drop of cobalt(II) chloride (30 g/l) TS and 1 drop of ammonia (~100 g/l) TS; a violet-red solution is produced.
- D. Dissolve 25 mg in 5 ml of hydrochloric acid (~70 g/l) TS, add about 0.2 g of zinc R powder and allow to stand for 5 minutes. Filter, and to the filtrate add 3 drops of sodium nitrite (10 g/l) TS and 0.5 ml of ammonium sulfamate (5 g/l) TS. After the reaction has subsided add 5 drops of

N-(1-naphthyl)ethylenediamine hydrochloride/ethanol TS; a deep red solution is produced.

Clarity and colour of solution. A solution of 0.20 g in 10 ml of citric acid (20 g/l) TS is clear and not more intensely coloured than standard colour solution Yw2 when compared as described under “Colour of liquids” (Vol. 1, p. 50).

Sulfated ash. Not more than 1.0 mg/g.

Loss on drying. Dry at 60 °C to constant mass under reduced pressure (not exceeding 0.6 kPa or about 5 mm of mercury); it loses not more than 5 mg/g.

Related substances. Carry out the test as described under “Thin-layer chromatography” (Vol. 1, p. 83), using silica gel R2 as the coating substance and 5 volumes of 1-butanol R, 2 volumes of water and 1 volume of acetic acid (~300 g/l) TS as the mobile phase. Apply separately to the plate 5 µl of each of the 3 following solutions in methanol R containing (A) 0.04 g of Dacarbazine per ml, (B) 0.4 mg of dacarbazine related compound A RS per ml, and (C) 0.4 mg of dacarbazine related compound B RS per ml. After removing the plate from the chromatographic chamber, allow it to dry in air, and examine the chromatogram in ultraviolet light (254 nm).

Any spot obtained with solution A, other than the principal spot, is not more intense or greater in size than that obtained with solution B (1%) and solution C (1%).

Assay

Note: The solutions must be protected from light throughout the assay.

Dissolve about 30 mg, accurately weighed, in sufficient hydrochloric acid (0.1 mol/l) VS to produce 50 ml of stock solution. For solution S₁ dilute 1.0 ml of the stock solution to 100 ml with hydrochloric acid (0.1 mol/l) VS. For solution S₂ dilute a further 1.0 ml aliquot of the stock solution to 100 ml with phosphate buffer, pH 7.0, TS. Measure the absorbance of a 1-cm layer of solution S₁ at the maximum at about 323 nm against a solvent cell containing hydrochloric acid (0.1 mol/l) VS. Measure the absorbance of a 1-cm layer of solution S₂ at the maximum at about 329 nm against a solvent cell containing phosphate buffer, pH 7.0, TS. Calculate the percentage content of C₆H₁₀N₆O.

Diethyltoluamidum

Diethyltoluamide

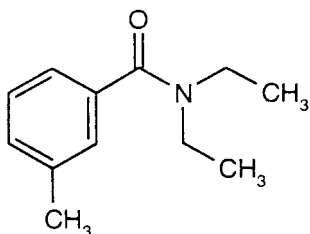

C₁₂H₁₇NO

Relative molecular mass. 191.3

Chemical name. *N,N*-Diethyl-*m*-toluamide; *N,N*-diethyl-3-methylbenzamide;
CAS Reg. No. 134-62-3.

Description. Colourless or faintly yellow liquid.

Solubility. Practically immiscible in water and glycerol R; miscible with ethanol (~750 g/l) TS and ether R.

Category. Insect repellent.

Storage. Diethyltoluamide should be kept in a tightly closed container.

Additional information. *CAUTION:* Diethyltoluamide is an irritant to eyes and mucous membranes.

Requirements

Diethyltoluamide contains not less than **97.0%** and not more than **103.0%** of C₁₂H₁₇NO, calculated with reference to the anhydrous substance.

Identity tests

- *Either test A alone or tests B, C, and D may be applied.*
- A. Carry out the examination as described under "Spectrophotometry in the infrared region" (Vol. 1, p. 40). The infrared absorption spectrum is concordant with the spectrum obtained from diethyltoluamide RS or with the *reference spectrum* of diethyltoluamide.
- B. Refractive index, $n_D^{20} = 1.520\text{--}1.524$.

- C. To about 2 ml, add 25 ml of hydrochloric acid (~250 g/l) TS and heat under a reflux condenser for 1 hour. Neutralize the solution with sodium hydroxide (~200 g/l) TS, cool, and extract with three quantities, each of 30 ml, of ether R. (Keep the aqueous layer for test D.) Carefully evaporate the ether layer to dryness on a water-bath, and dissolve the residue in 5 ml of sodium nitrite (100 g/l) TS. Allow to stand at 5 °C for 10 minutes, add 10 ml of water, and extract with 20 ml of ether R. Evaporate the ether layer and add to the residue 1.0 g of phenol R. Cool and add about 1 ml of sulfuric acid (~1760 g/l) TS; an intense green solution is produced. Pour the mixture into water; the colour turns to red. Add sodium hydroxide (~80 g/l) TS; the colour changes to green.
- D. Acidify the aqueous layer obtained in test C with hydrochloric acid (~70 g/l) TS, extract with two quantities, each of 20 ml of ether R, and carefully evaporate the ether layer. Dry the residue at 60 °C; the melting temperature of the residue is about 108 °C.

Mass density. $\rho_{20} = 0.996\text{--}1.002$.

Sulfated ash. Not more than 1.0 mg/g.

Water. Determine as described under “Determination of water by the Karl Fischer method”, Method A (Vol. 1, p. 135), using about 0.5 g of the substance; the water content is not more than 5.0 mg/g.

Acidity. Dissolve 10.0 g in 50 ml of neutralized ethanol TS, titrate with sodium hydroxide (0.01 mol/l) VS using phenolphthalein/ethanol TS as indicator; not more than 4.0 ml of sodium hydroxide (0.01 mol/l) VS is required to obtain the midpoint of the indicator (pink).

Assay. Carry out Method A as described under “Determination of nitrogen” (Vol. 1, p. 136), using about 0.3 g, accurately weighed, and 7 ml of nitrogen-free sulfuric acid (~1760 g/l) TS, and proceed with the distillation. Titrate with sulfuric acid (0.05 mol/l) VS using methyl red/ethanol TS as indicator. Repeat the procedure without the Diethyltoluamide being examined and make any necessary corrections.

Each ml of sulfuric acid (0.05 mol/l) VS is equivalent to 19.13 mg of $\text{C}_{12}\text{H}_{17}\text{NO}$.

Dinitrogenii oxidum

Dinitrogen oxide

N_2O

Relative molecular mass. 44.01

Chemical name. Nitrous oxide; CAS Reg. No. 10024-97-2.

Other name. Nitrous oxide.

Description. A colourless gas; odourless.

Solubility. One volume dissolves in about 1.5 volumes of water at a pressure of 101.3 kPa and a temperature of 20 °C.

Category. Inhalational anaesthetic gas.

Storage. Dinitrogen oxide should be kept as compressed gas or liquid at very low temperatures, in appropriate containers complying with the safety regulations of the national authority.

Labelling. An ISO standard¹ requires that cylinders containing Dinitrogen oxide intended for medical use should bear the name of the contents in legible and permanent characters and, preferably, also the molecular formula N₂O.

Additional information. In the analysis of medicinal gases certain tests are not intended for hospital pharmacists. They are applicable solely by laboratories equipped with specialized apparatus.

Valves or taps should not be lubricated with oil or grease. It is recommended that cylinders marked as described above are not used for other gases.

Requirements

Dinitrogen oxide contains not less than **98.0% v/v** of N₂O in the gaseous phase, when sampled at 15 °C.

Note: If the test is performed on a cylinder, keep the cylinder of the gas to be examined at room temperature for at least 6 hours before carrying out the tests. Keep the cylinder in the vertical position with the outlet valve uppermost.

The test for carbon monoxide should be carried out on the first portion of gas drawn from the container and the tests for nitrogen monoxide and nitrogen dioxide immediately thereafter.

¹ *International Standard 32. Gas cylinders for medical use – marking for identification content.* International Organization for Standardization, Switzerland, 1977.

Identity tests

- *Either test A alone or tests B, C, and D may be applied.*
- A. Carry out the examination as described under "Spectrophotometry in the infrared region" (Vol. 1, p. 40). The infrared absorption spectrum is concordant with the *reference spectrum* of dinitrogen oxide.
- B. Place a glowing splinter of wood into the gas; the splinter bursts into flame.
- C. Shake the gas with alkaline pyrogallol TS; it is not absorbed and the solution does not become brown (distinction from oxygen).
- D. Mix the gas with an equal volume of nitrogen monoxide R; no red fumes are produced (distinction from oxygen).

Carbon monoxide

- *Either test A, test B, or test C may be applied.*

Note: The tests should be carried out on the first portion of gas released from the container.

- A. The apparatus (Fig. 6) consists of the following parts connected in series:
 - a U-tube (U1) containing desiccant silica gel R impregnated with chromium trioxide R;
 - a wash bottle (F1) containing 100 ml of potassium hydroxide (~400 g/l) TS;
 - a U-tube (U2) containing pellets of potassium hydroxide R;
 - a U-tube (U3) containing phosphorus pentoxide R dispersed on previously granulated, fused pumice;
 - a U-tube (U4) containing 30 g of recrystallized iodine pentoxide R in granules, previously dried at 200 °C and kept at a temperature of 120 °C (T) during the test. The iodine pentoxide is packed in the tube in 1-cm columns separated by 1-cm columns of glass wool to give an effective length of 5 cm;
 - a reaction tube (F2) containing 2.0 ml of potassium iodide (160 g/l) TS and 0.15 ml of starch TS.

Flush the apparatus with 5.0 litres of argon R. If necessary, discharge the blue colour in tube F2 containing potassium iodide (160 g/l) TS by adding a sufficient volume of freshly prepared sodium thiosulfate (0.002 mol/l) VS. Continue flushing with gas until not more than 0.045 ml of sodium thiosulfate (0.002 mol/l) VS is required after the passage of 5.0 litres of argon R. Pass 5.0 litres of Dinitrogen oxide from the container through the apparatus. Flush the last traces of liberated iodine into the reaction tube by passing 1.0 litre of argon R through the apparatus. Titrate the liberated iodine with

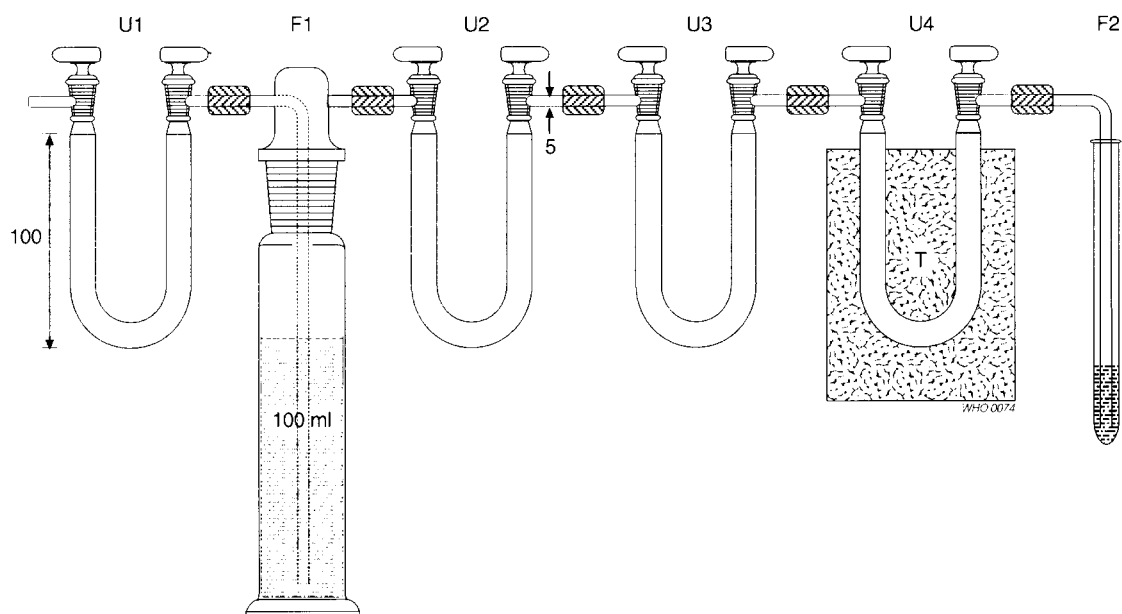

Figure 6. Apparatus for the determination of carbon monoxide in medicinal gases
Measurements in mm.

Reproduced with the permission of the European Pharmacopoeia Commission,
European Directorate for the Quality of Medicines, Council of Europe.

sodium thiosulfate (0.002 mol/l) VS. Repeat the procedure using 5.0 litres of argon R.

The difference between the volumes of sodium thiosulfate (0.002 mol/l) VS used in the titrations is not more than 0.25 ml (5 µl/l).

- B. Carry out the test as described under "Gas chromatography" (Vol. 1, p. 94), using a stainless steel column (2 m × 4 mm) packed with a 0.5- nm molecular sieve (e.g. X13, obtainable from a commercial source). Maintain the column at 80 °C, and the injection port and the detector at room temperature. Use helium R as the carrier gas at a flow rate of 60 ml per minute, and a helium ionization detector.

Use the following gases: (1) Dinitrogen oxide; and (2) a mixture containing 5 µl of carbon monoxide R in 1 litre of dinitrogen oxide R as the reference gas.

Inject a suitable volume of both gases (1) and (2). Adjust the volume, as well as the conditions specified above, to produce a peak response for carbon monoxide obtained with the reference gas (2) that gives a height of not less than 5% on the recorder.

Measure the areas of the peak responses obtained in the chromatograms from injections 1 and 2 and calculate the content of carbon monoxide in

Dinitrogen oxide (1) by comparing with the peak response for carbon monoxide obtained from the reference gas (2); not more than 5 µl/l.

- C. Determine the content using a carbon monoxide detector tube. Pass the required volume of Dinitrogen oxide through the tube, the calibration of which is verified according to the manufacturer's instructions.

The gas supply is connected to a pressure regulator and needle valve. Connect the flexible tubing fitted with a Y-piece to the valve and adjust the flow of Dinitrogen oxide to purge the tubing to an appropriate flow. Fit the carbon monoxide detector tube to the metering pump according to the manufacturer's instructions. Connect the open end of the tube to the short leg of the tubing and pump a suitable volume of Dinitrogen oxide through the tube. Read the value corresponding to the length of the coloured layer or the intensity of the colour on the graduated scale; not more than 5 µl/l.

Note: For the following tests – Nitrogen monoxide and nitrogen dioxide, Carbon dioxide Test A, Halogens and hydrogen sulfide, and Acidity and alkalinity – pass the gas to be tested through the appropriate reagent contained in a hermetically closed flat-bottomed glass cylinder, with dimensions such that 50 ml of liquid reaches a height of 12–14 cm, that is fitted with (a) a delivery tube terminated by a capillary 1 mm in internal diameter and placed within 2 mm of the bottom of the cylinder; and (b) an outlet tube.

Prepare the reference solutions in identical cylinders.

Nitrogen monoxide and nitrogen dioxide

- *Either test A or test B may be applied.*

Note: This test should be performed after release of the 5.0 litres of gas as described above under "Carbon monoxide, test A".

- A. Pass Dinitrogen oxide through two of the cylinders connected in series as described above under "Carbon monoxide, test A". To obtain the liquid phase invert the gas cylinder; the liquid vaporizes on leaving the valve.

To 50 ml of water add 1.2 ml of sulfuric acid (~1760 g/l) TS and dilute with sufficient water to produce 100 ml. To 15 ml of this solution add 375 mg of potassium permanganate R, mix, and transfer to the first cylinder (*solution A*).

Dissolve 1 g of sulfanilic acid R in a mixture of 180 ml of water and 10 ml of glacial acetic acid R (*solution 1*). Separately dissolve 0.2 g of *N*-(1-naphthyl)ethylenediamine hydrochloride R in a mixture of 4 ml of glacial acetic acid R and 5 ml of water, heat gently, and dilute to 200 ml with water

(solution 2). Mix 1 volume of solution 2 with 9 volumes of solution 1 and transfer 20 ml of this mixture to the second cylinder (*solution B*).

Connect the outlet tube of the first cylinder to the delivery tube of the second cylinder containing solution B. Pass 2.5 litres of Dinitrogen oxide through the reagents at a rate of 15.0 litres per hour.

Prepare a reference solution by adding 0.25 ml of a solution containing 61.6 µg/ml of sodium nitrite R in water to 20 ml of solution B as prepared above. Allow the test solution and reference solution to stand for 10 minutes.

Examine the gaseous and the liquid phases separately.

For both gaseous and liquid phases, any red colour produced from the solution of Dinitrogen oxide is not more intense than that from the reference solution (2 µl/l of NO + NO₂).

- B. Determine the content using a nitrogen monoxide and nitrogen dioxide detector tube. Pass the required volume of Dinitrogen oxide through the tube, the calibration of which is verified according to the manufacturer's instructions.

The gas supply is connected to a pressure regulator and needle valve. Connect the flexible tubing fitted with a Y-piece to the valve and adjust the flow of Dinitrogen oxide to purge the tubing to an appropriate flow. Fit the nitrogen monoxide and nitrogen dioxide detector tube to the metering pump following the manufacturer's instructions. Connect the open end of the tube to the short leg of the tubing and pump a suitable volume of Dinitrogen oxide through the tube. Read the value corresponding to the length of the coloured layer or the intensity of the colour on the graduated scale; not more than 2 µl/l.

Carbon dioxide

- *Either test A, test B, or test C may be applied.*

- A. Pass 1.0 litre of Dinitrogen oxide through 50 ml of a clear solution of barium hydroxide (0.15 mol/l) VS. Similarly prepare a reference solution by adding 1.0 ml of a 1.1 mg/ml solution of sodium hydrogen carbonate R in carbon-dioxide-free water R to 50 ml of barium hydroxide (0.15 mol/l) VS.

Any turbidity in the solution after the passage of the Dinitrogen oxide is not more intense than that of the reference solution (300 µl/l).

- B. Carry out the test as described under "Gas chromatography" (Vol. 1, p. 94), using a stainless steel column (3.5 m × 2 mm) packed with ethylvinyl-

benzenedivinylbenzene copolymer. Maintain the column at 40 °C and the detector at 90 °C. Use helium R as the carrier gas at a flow rate of 15 ml per minute, and a thermal conductivity detector.

Use the following gases: (1) Dinitrogen oxide; and (2) a mixture containing 300 µg of carbon dioxide R in 1 litre of dinitrogen oxide R as the reference gas.

Inject a suitable volume of both gases (1) and (2). Adjust the volume, as well as the conditions specified above, to obtain a peak response for carbon dioxide obtained with the reference gas (2) of a height of not less than 35% on the recorder.

Measure the areas of the peak responses obtained in the chromatograms from the injections of gases 1 and 2 and calculate the content of carbon dioxide in Dinitrogen oxide (1) by comparing with the peak response for carbon dioxide obtained from the reference gas (2); not more than 300 µl of CO₂ per litre.

- C. Determine the content using a carbon dioxide detector tube. Pass the required volume of Dinitrogen oxide through the tube, the calibration of which is verified according to the manufacturer's instructions.

The gas supply is connected to a suitable pressure regulator and needle valve. Connect the flexible tubing fitted with a Y-piece to the valve and adjust the flow of Dinitrogen oxide to purge the tubing to an appropriate flow. Fit the carbon dioxide detector tube to the metering pump according to the manufacturer's instructions. Connect the open end of the tube to the short leg of the tubing and pump a suitable volume of Dinitrogen oxide through the tube. Read the value corresponding to the length of the coloured layer or the intensity of the colour on the graduated scale; not more than 300 µl/l.

Halogens and hydrogen sulfide. Pass 20.0 litres of Dinitrogen oxide through a mixture of 1 ml of silver nitrate (40 g/l) TS and 49 ml of water at a flow rate not exceeding 15 litres per hour.

Prepare the reference solution as follows: to 1.0 ml of silver nitrate (40 g/l) TS add 40 ml of chloride standard (5 µg/ml) TS and 0.15 ml of nitric acid (~130 g/l) TS, dilute to 50 ml with water, and allow to stand protected from light for 5 minutes. For the blank solution, repeat the procedure passing Dinitrogen oxide through 50 ml of water.

Compare a 100-mm layer of the solution as described under "Colour of liquids" (Vol. 1, p. 50).

The solution of Dinitrogen oxide does not darken when compared with the blank. Any opalescence is not more intense than that of the reference solution (10 µg Cl per litre of dinitrogen oxide).

Water

- *Either test A or test B may be applied.*
- A. The apparatus consists of either an electrolytic hygrometer as described below, an appropriate humidity detector tube, or a capacity hygrometer.

The measuring cell consists of a thin film of phosphoric anhydride placed between two coiled platinum wires which act as electrodes. The water vapour in Dinitrogen oxide is absorbed by the phosphoric anhydride to form phosphoric acid which acts as an electrical conductor.

Before introducing Dinitrogen oxide into the device, allow the gas to stabilize at room temperature and make sure that the temperature is constant throughout the apparatus. Apply a continuous voltage across the electrodes to produce electrolysis of the water and regeneration of phosphoric anhydride. Measure the resulting electric current, which is proportional to the water content in Dinitrogen oxide. (This is a self-calibrating system that obeys Faraday's law.)

Calculate the content of water; not more than 60 µg/l.

- B. Determine the content using a water vapour detector tube. Pass the required volume of Dinitrogen oxide through the tube, the calibration of which is verified according to the manufacturer's instructions.

The gas supply is connected to a suitable pressure regulator and needle valve. Connect the flexible tubing fitted with a Y-piece to the valve and adjust the flow of Dinitrogen oxide to purge the tubing to an appropriate flow. Fit the water vapour detector tube to the metering pump according to the manufacturer's instructions. Connect the open end of the tube to the short leg of the tubing and pump a suitable volume of Dinitrogen oxide through the tube. Read the value corresponding to the length of the coloured layer or the intensity of the colour on the graduated scale; not more than 60 µl/l.

Acidity and alkalinity. Pass 2.0 litres of Dinitrogen oxide through a mixture of 0.10 ml of hydrochloric acid (0.01 mol/l) VS and 50 ml of carbon-dioxide-free water R.

For *reference solution 1*, use 50 ml of carbon-dioxide-free water R. For *reference solution 2*, use a mixture of 0.20 ml of hydrochloric acid (0.01 mol/l) VS and 50 ml of carbon-dioxide-free water R.

To each solution add 0.1 ml of methyl red/ethanol TS; the intensity of the colour in the Dinitrogen oxide solution is between that of reference solutions 1 and 2.

Assay. Determine as described under "Gas chromatography" (Vol. 1, p. 94), using a stainless steel column (2 m × 2 mm) packed with silica gel for chromatography R (250–355 µm). Maintain the column at 60 °C and the detector at 130 °C. Use helium R as the carrier gas at a flow rate of 50 ml per minute, and a thermal conductivity detector.

Use the following gases: (1) Dinitrogen oxide; and (2) dinitrogen oxide R as the reference gas.

Inject a suitable volume of both gases (1) and (2). Adjust the volume, as well as the conditions specified above, to produce a peak response for dinitrogen oxide obtained with reference gas (2) that gives a height of not less than 35% on the recorder.

Measure the areas of the peak responses obtained in the chromatograms from the injections of gases (1) and (2), and calculate the percentage content of Dinitrogen oxide.

Dithranolum

Dithranol

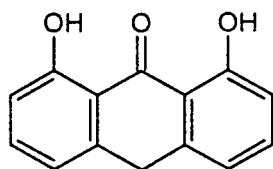

Relative molecular mass. 226.2

Chemical name. 1,8,9-Anthratriol; CAS Reg. No. 1143-38-0.

Other name. Anthralin.

Description. A yellow or brownish yellow, crystalline powder.

Solubility. Practically insoluble in water; soluble in dichloromethane R; sparingly soluble in acetone R; slightly soluble in ethanol (~750 g/l) TS and ether R.

Category. Keratolytic agent.

Storage. Dithranol should be kept in a tightly closed container, protected from light.

Requirements

Dithranol contains not less than **98.5%** and not more than **101.0%** of $C_{14}H_{10}O_3$, calculated with reference to the dried substance.

Identity tests

- *Either tests A and D or tests B, C, and D may be applied.*
- A. Carry out the examination as described under “Spectrophotometry in the infrared region” (Vol. 1, p. 40). The infrared absorption spectrum is concordant with the spectrum obtained from dithranol RS or with the *reference spectrum* of dithranol.
- B. The absorption spectrum of a 10 µg/ml solution in dichloromethane R, when observed between 250 nm and 450 nm, exhibits 3 maxima at about 256 nm, 288 nm, and 356 nm. The absorbance of a 1-cm layer at the maximum wavelength at 356 nm is about 0.46 and at 288 nm about 0.49.
- C. Carry out the test as described under “Thin-layer chromatography” (Vol. 1, p. 83), using silica gel R3 as the coating substance and a mixture of equal volumes of hexane R and dichloromethane R as the mobile phase. Apply separately to the plate 10 µl of each of 3 solutions in dichloromethane R containing (A) 1.0 mg of Dithranol per ml, (B) 1.0 mg of dithranol RS, and for solution (C) dissolve 5 mg of dantron R in 5 ml of solution B. After removing the plate from the chromatographic chamber, allow it to dry in air. Place the plate in a chamber saturated with ammonia vapour until the spots appear. Examine the chromatogram in daylight.

The principal spot obtained with solution A corresponds in position, appearance, and intensity with that obtained with solution B. The test is not valid unless the chromatogram obtained with solution C shows two clearly separated spots.

D. Melting temperature, about 180°C.

Chlorides. Dissolve 2.5 g in a mixture of 2.0 ml of nitric acid (~130 g/l) TS and 30 ml of water, and proceed as described under “Limit test for chlorides” (Vol. 1, p. 116); the chloride content is not more than 0.1 mg/g.

Sulfated ash. Not more than 1.0 mg/g.

Loss on drying. Dry to constant mass at 105°C; it loses not more than 5 mg/g.

pH value. Shake 1.5 g with 30 ml of carbon-dioxide-free water R for 1 minute and filter; pH of the filtrate, 6.0–7.6.

Related substances

- A. Carry out the test as described under “High-performance liquid chromatography” (p. 257), using a stainless steel column (25 cm × 4.6 mm) packed with *stationary phase C* (5 μm). As the mobile phase, use a mixture of 82 volumes of hexane R, 5 volumes of dichloromethane R, and 1 volume of glacial acetic acid R.

Prepare the following solutions. For solution (A) dissolve 0.20 g of Dithranol in 20 ml of dichloromethane R, add 1.0 ml of glacial acetic acid R, and dilute to 100 ml with hexane R. For solution (B) dissolve 10.0 mg of each of anthrone R, dantron R, 9,9'-bisanthracene-10,10'(9*H*,9'*H*)-dione RS, and dithranol RS in dichloromethane R, and dilute to 10.0 ml with the same solvent. To 1.0 ml of this solution add 19 ml of dichloromethane R and 1.0 ml of glacial acetic acid R, and dilute to 50 ml with hexane R.

Operate with a flow rate of 2.0 ml per minute. As a detector use an ultraviolet spectrophotometer set at a wavelength of 260 nm.

Inject 20 μl each of solutions A and B. Continue the chromatography for 1.5 times the retention time of the peak due to 9,9'-bisanthracene-10,10'(9*H*,9'*H*)-dione obtained with solution B. Adjust the sensitivity of the system so that the height of the peak due to dithranol in the chromatogram obtained with solution B is about 70% of the full scale of the recorder. The peaks are eluted in the following order: dithranol, dantron, anthrone and 9,9'-bisanthracene-10,10'(9*H*,9'*H*)-dione. The test is not valid unless, in the chromatogram obtained with solution B, the resolution between the peaks due to dithranol and dantron is greater than 2.0.

Measure the areas of the peak responses obtained in the chromatograms from solutions A and B, and calculate the content of the related substances as a percentage. In the chromatogram obtained with solution A, the area of any peak corresponding to anthrone, dantron or 9,9'-bisanthracene-10,10'(9*H*,9'*H*)-dione is not greater than that of the corresponding peak in the chromatogram obtained with solution B (1.0%). The area of any peak, other than the principal peak and any peaks due to anthrone, dantron or 9,9'-bisanthracene-10,10'(9*H*,9'*H*)-dione, is not greater than that of

the peak due to dithranol in the chromatogram obtained with solution B (1.0%).

- B. Carry out the test as described under “High-performance liquid chromatography” (p. 257), using a stainless steel column (20 cm × 4.6 mm) packed with *stationary phase A* (5 μm). As the mobile phase, use a mixture of 60 volumes of water, 40 volumes of tetrahydrofuran R, and 2.5 volumes of glacial acetic acid R.

Prepare the following solutions in the mobile phase: solution (A) 1.0 mg of Dithranol per ml; and for solution (B) dissolve 0.5 mg of 1-hydroxy-9-anthrone RS and 0.5 mg of dithranol RS per ml, and dilute 1.0 ml of this solution to 20 ml with the mobile phase.

Operate with a flow rate of about 0.9 ml per minute. As a detector use an ultraviolet spectrophotometer set at a wavelength of 254 nm.

Inject 20 μl each of solutions A and B. Continue the chromatography for 3 times the retention time of the peak due to dithranol. The test is not valid unless, in the chromatogram obtained with solution B, the resolution between the peaks due to 1-hydroxy-9-anthrone and dithranol is greater than 2.5.

Measure the areas of the peak responses obtained in the chromatograms from solutions A and B, and calculate the content of the related substances as a percentage. In the chromatogram obtained with solution A, the area of any peak corresponding to 1-hydroxy-9-anthrone is not greater than that of the corresponding peak in the chromatogram obtained with solution B (2.5%).

The total content of related substances as determined in tests A and B is not more than 3.0%.

Assay. Dissolve about 0.2 g, accurately weighed, in 50 ml of anhydrous pyridine R and titrate under an atmosphere of nitrogen with tetrabutylammonium hydroxide (0.1 mol/l) VS as described under “Non-aqueous titration”, Method B (Vol. 1, p. 132), determining the end-point potentiometrically.

Each ml of tetrabutylammonium hydroxide (0.1 mol/l) VS is equivalent to 22.62 mg of C₁₄H₁₀O₃.

Erythromycini lactobionas

Erythromycin lactobionate

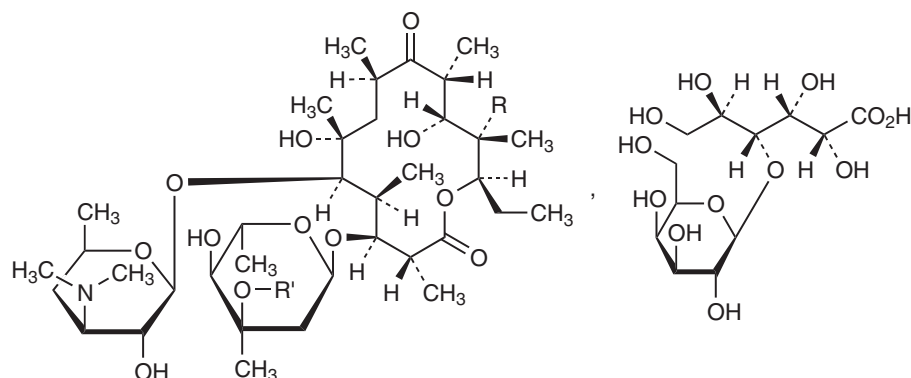

Erythromycin	R	R'
A	OH	CH ₃
B	H	CH ₃
C	OH	H

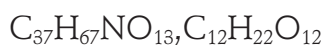

Relative molecular mass. 1092

Chemical name. Erythromycin lactobionate (1:1) (salt); erythromycin mono(4-O-β-D-galactopyranosyl-D-gluconate) (salt); CAS Reg. No. 3847-29-8.

Description. White or slightly yellow crystals or a white, crystalline powder; odour, faint.

Solubility. Freely soluble in water, ethanol (~750 g/l) TS and methanol R; slightly soluble in acetone R; practically insoluble in ether R.

Category. Antibacterial drug.

Storage. Erythromycin lactobionate should be kept in a tightly closed container, protected from light.

Additional information. Each mg of erythromycin lactobionate is equivalent to 0.6722 mg of erythromycin.

Identity tests

- Either test A alone or tests B, C, and D may be applied.
- Carry out the examination as described under “Spectrophotometry in the infrared region” (Vol. 1, p. 40). The infrared absorption spectrum is concordant with the spectrum obtained from erythromycin lactobionate RS or with the *reference spectrum* of erythromycin lactobionate.
 - See the test described below under “Related substances”. One of the two principal spots obtained with solution A corresponds in position with the principal spot obtained with solution B. The other principal spot corresponds in position with the principal spot obtained with solution D.
 - Dissolve 20 mg in 2.0 ml of water and cautiously add about 1 ml of sulfuric acid (~1760 g/l) TS to form a lower layer; a red-brown ring appears at the interface of the two liquids. Shake; a dark red-brown solution is produced.
 - Dissolve about 10 mg in 5 ml of hydrochloric acid (~250 g/l) TS; a yellowish green colour develops.

Clarity and colour of solution. A solution of 0.85 g in 10 ml of water is clear or not more opalescent than opalescence standard TS1, and colourless or not more intensely coloured than standard colour solution Yw1 when compared as described under “Colour of liquids” (Vol. 1, p. 50).

Water. Determine as described under “Determination of water by the Karl Fischer method”, Method A (Vol. 1, p. 135), using about 0.5 g of Erythromycin lactobionate; the water content is not more than 0.050 g/g.

Sulfated ash. Not more than 20 mg/g.

pH value. pH of a 0.05 g/ml solution in carbon-dioxide-free water R, 6.0–7.5.

Related substances. Carry out the test as described under “Thin-layer chromatography” (Vol. 1, p. 83), using silanized silica gel R3 as the coating substance and a mixture of 5 volumes of methanol R and 3 volumes of ammonium acetate (50 g/l) TS as the mobile phase. Apply separately to the plate 10 µl of each of 4 solutions in methanol R containing (A) 3 mg of Erythromycin lactobionate per ml, (B) 2 mg of erythromycin RS per ml, (C) 0.10 mg of erythromycin RS per ml, and (D) 0.66 mg of lactobionic acid R per ml. After removing the plate from the chromatographic chamber, allow it to dry in air until the solvents have evaporated, spray with anisaldehyde TS, heat at 110 °C for 5 minutes, and allow to cool. Examine the chromatogram in daylight.

Disregard the spot corresponding to lactobionic acid. Any spot obtained with solution A, other than the principal spot and any spot with a lower R_f -value,

is not more intense than that obtained with solution B. Any spot obtained with solution A, other than the principal spot and any spot with a higher R_f -value, is not more intense than that obtained with solution C.

Assay. Carry out the determination as described under "Microbiological assay of antibiotics" (Vol. 1, p. 145), using either (a) *Bacillus pumilus* (NCTC 8241 or ATCC 14884) as the test organism, culture medium Cm1 with a final pH of 8.0–8.1, sterile phosphate buffer, pH 8.0, TS, an appropriate concentration of erythromycin (usually between 5 and 25 IU per ml), and an incubation temperature of 35–39 °C, or (b) *Micrococcus luteus* (ATCC 9341) as the test organism, culture medium Cm1 with a final pH of 8.0–8.1, sterile phosphate buffer, pH 8.0, TS1, or TS2, an appropriate concentration of erythromycin (usually between 0.5 and 1.5 IU per ml), and an incubation temperature of 32–35 °C. The precision of the assay is such that the fiducial limits of error of the estimated potency ($P = 0.95$) are not less than 95% and not more than 105% of the estimated potency.

The potency is not less than 600 IU of erythromycin per mg, calculated with reference to the anhydrous substance.

Etoposidum

Etoposide

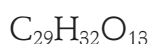
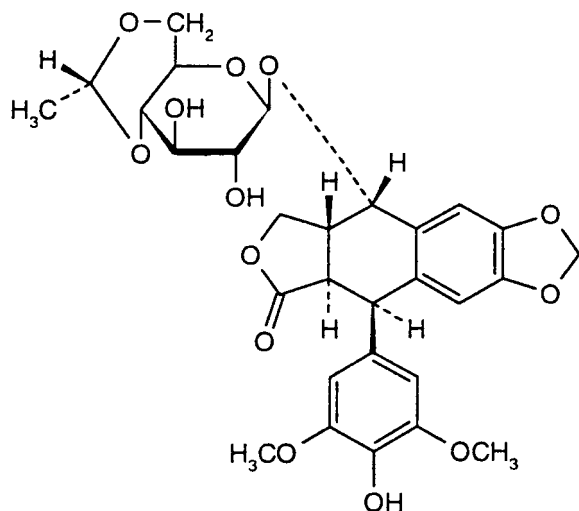

Relative molecular mass. 588.6

Chemical name. 4'-Demethylepipodophyllotoxin 9-(4,6-O-ethylidene- β -D-glucopyranoside); [5R-[5 α ,5a β ,8a α ,9 β (R*)]]-9-[(4,6-O-ethylidene- β -D-glucopyranoside)]

pyranosyl)oxy]-5,8,8a,9-tetrahydro-5-(4-hydroxy-3,5-dimethoxyphenyl)furo[3',4':6,7]naphtho[2,3-*d*]-1,3-dioxol-6(5a*H*)-one; CAS Reg. No. 33419-42-0.

Description. A white or almost white, crystalline powder.

Solubility. Practically insoluble in water; sparingly soluble in methanol R; slightly soluble in ethanol (~750 g/l) TS and dichloromethane R.

Category. Cytotoxic drug.

Storage. Etoposide should be kept in a tightly closed container.

Labelling. The designation Etoposide for parenteral use indicates that the substance complies with the additional requirements and may be used for parenteral administration. Expiry date.

Additional information. *CAUTION:* Etoposide must be handled with care, avoiding contact with the skin and inhalation of airborne particles.

Requirements

Etoposide contains not less than **98.0%** and not more than the equivalent of **102.0%** of $C_{29}H_{32}O_{13}$, calculated with reference to the dried substance.

Identity tests

- *Either test A alone or tests B, C, and D may be applied.*
- A. Carry out the examination as described under "Spectrophotometry in the infrared region" (Vol. 1, p. 40). The infrared absorption spectrum is concordant with the spectrum obtained from etoposide RS or with the *reference spectrum* of etoposide.
- B. See the test described below under "Related substances". The principal band obtained with solution B corresponds in position, appearance, and intensity with that obtained with solution C.
- C. Transfer about 5 mg to a test-tube and dissolve in 5 ml of glacial acetic acid R, add about 0.1 ml of ferric chloride (50 g/l) TS, and mix. Cautiously add about 2 ml of sulfuric acid (~1760 g/l) TS. Without mixing allow to stand for about 30 minutes; a pink to reddish brown ring develops at the interface and the upper layer is yellow.
- D. Dissolve 5 mg in 5 ml of methanol R, add 5 ml of hydrochloric acid (~70 g/l) TS, and evaporate to dryness on a water-bath. To the residue add 20 ml of water and 10 ml of dichloromethane R, and shake vigorously. Allow to sep-

arate and to 1.0 ml of the aqueous layer add 2.0 ml of anthrone TS2 and mix; a blue-green colour is produced.

Specific optical rotation. Dissolve 0.050 g in 10 ml of a mixture of 1 volume of methanol R and 9 volumes of dichloromethane R; $[\alpha]_{\text{D}}^{20\text{ }^{\circ}\text{C}} = -106^{\circ}$ to -114° , calculated with reference to the dried substance.

Heavy metals. Use 1.0 g for the preparation of the test solution as described under “Limit test for heavy metals”, Procedure 3 (Vol. 1, p. 118); determine the heavy metals content according to Method A (Vol. 1, p. 119); not more than 20 µg/g.

Solution in methanol/dichloromethane. Dissolve 0.6 g in 20 ml of a mixture of 1 volume of methanol R and 9 volumes of dichloromethane R; the solution is clear and not more intensely coloured than standard colour solution 2 of the most appropriate hue, when compared as described under “Colour of liquids” (Vol. 1, p. 50).

Sulfated ash. Not more than 1.0 mg/g.

Loss on drying. Dry at 105 °C under reduced pressure (not exceeding 0.6 kPa or about 5 mm of mercury) for 4 hours; it loses not more than 30 mg/g.

Related substances. Carry out the test as described under “Thin-layer chromatography” (Vol. 1, p. 83), using silica gel R1 as the coating substance and a mixture of 100 volumes of dichloromethane R, 20 volumes of acetone R, 8 volumes of glacial acetic acid R, and 1.5 volumes of water as the mobile phase. Apply separately to the plate 5 µl, spread to form 10-mm bands, of each of 5 solutions in a mixture of 1 volume of methanol R and 9 volumes of dichloromethane R containing (A) 0.050 g of Etoposide per ml, (B) 5 mg of Etoposide per ml, (C) 5 mg of etoposide RS per ml, (D) 0.25 mg of etoposide RS per ml, and (E) 0.10 mg of etoposide RS per ml. After removing the plate from the chromatographic chamber, dry it in a current of warm air for 5 minutes. Spray with a mixture of 1 volume of sulfuric acid (~1760 g/l) TS and 9 volumes of ethanol (~750 g/l) TS, and heat at 140 °C for 15 minutes. Cover the plate immediately with a glass plate of the same size. Examine the chromatogram in daylight.

Any band obtained with solution A, other than the principal band, is not more intense than that obtained with solution D. Furthermore, not more than two such bands are more intense than the band obtained with solution E (0.2%).

Assay. Determine as described under “High-performance liquid chromatography” (p. 257), using a stainless steel column (25 cm × 4.6 mm) packed with *stationary phase A* (10 µm). Prepare a diluted solution of acetic acid as follows to be used in the mobile phase and for the preparation of solution C: to 96 ml of water

add 4 ml of glacial acetic acid R. As the mobile phase, use a mixture of 76 volumes of the diluted acetic acid solution and 24 volumes of acetonitrile R.

Prepare the following solutions in methanol R: solution (A) 1.0 mg of Etoposide per ml; solution (B) 1.0 mg of etoposide RS per ml; and for solution (C) add 0.1 ml of the diluted acetic acid solution described above and 0.1 ml of phenolphthalein/ethanol TS to 10 ml of solution A, then add sodium hydroxide (1 mol/l) VS until the solution becomes faintly pink (about 0.15 ml), allow to stand for 15 minutes, and add 0.1 ml of the diluted acetic acid solution described above.

Operate with a flow rate of 2.0 ml per minute. As a detector use an ultraviolet spectrophotometer set at a wavelength of about 285 nm.

Inject 10 µl of solution C. Allow the chromatography to continue until the peak corresponding to phenolphthalein is eluted. Phenolphthalein has a retention time relative to etoposide of about 2.7. Disregard any peak due to phenolphthalein. The assay is not valid unless the chromatogram shows two principal peaks and the resolution between these peaks is at least 1.5. If necessary, reduce the concentration of acetonitrile R in the mobile phase or reduce the flow rate to achieve the required resolution.

Inject alternately 10 µl each of solutions A and B.

Measure the areas of the peak responses obtained in the chromatograms from solutions A and B, and calculate the percentage content of $C_{29}H_{32}O_{13}$.

Additional requirements for Etoposide for parenteral use

Complies with monograph for "Parenteral preparations" (see Vol. 4, p. 36).

Bacterial endotoxins. Carry out the test as described under "Test for bacterial endotoxins" (p. 30); contains not more than 2.0 IU of endotoxin RS per mg.

Heparinum calcicum

Heparin calcium

Composition. Heparin calcium is a preparation containing the calcium salt of a sulfated glucosaminoglycan present in mammalian tissues. It has the characteristic property of delaying the clotting of fresh blood; CAS Reg. No. 37270-89-6.

Description. A white or almost white powder.

Solubility. Freely soluble in water.

Category. Anticoagulant.

Storage. Heparin calcium should be kept in a tightly closed container.

Labelling. The designation Heparin calcium for parenteral use indicates that the substance complies with the additional requirements and may be used for parenteral administration. The label should also state the name and quantity of any added substances, and the source of the material (lung or mucosal). Expiry date.

Additional information. Heparin calcium may be prepared from the lungs of oxen or the intestinal mucosae of oxen, pigs, or sheep. Attention should be paid to minimize or eliminate microbiological contamination and substances lowering blood pressure. Heparin calcium is moderately hygroscopic.

Requirements

Heparin calcium intended for the manufacture of a parenteral dosage form contains not less than **150 IU per mg**, and Heparin calcium not intended for use in the manufacture of a parenteral dosage form contains not less than **120 IU per mg**, both calculated with reference to the dried substance.

Identity tests

- A. Delays the clotting of fresh blood.
- B. Specific optical rotation, use a 40 mg/ml solution; $[\alpha]_{\text{D}}^{20\text{ }^{\circ}\text{C}}$ = not less than +35°.
- C. A 20 mg/ml solution yields the reactions described under “General identification tests” as characteristic of calcium (Vol. 1, p. 112).

Heavy metals. Use 0.5 g for the preparation of the test solution as described under “Limit test for heavy metals”, Procedure 3 (Vol. 1, p. 118); determine the heavy metals content according to Method A (Vol. 1, p. 119); not more than 30 µg/g.

Calcium. Proceed with about 0.2 g, accurately weighed, as described under “Complexometric titrations” for calcium (Vol. 1, p. 128). Each ml of disodium edetate (0.05 mol/l) VS is equivalent to 2.004 mg of Ca; 95–115 mg/g, calculated with reference to the dried substance. (As an alternative, determine the content of calcium by atomic absorption spectrophotometry.)

Nitrogen. Carry out Method A as described under “Determination of nitrogen” (Vol. 1, p. 136), using about 0.1 g, accurately weighed, and 5 ml of nitrogen-free sulfuric acid (~1760 g/l) TS. Each ml of sulfuric acid (0.05 mol/l) VS is equivalent to 1.401 mg of nitrogen; not more than 25 mg/g, with reference to the dried substance.

Protein and nucleotidic impurities. Measure the absorbance of a 1-cm layer of a 4 mg/ml solution at a wavelength of 260 nm and 280 nm; at 260 nm not greater than 0.20 and at 280 nm not greater than 0.15.

Clarity and colour of solution. A solution containing 5000 IU per ml is clear and not more intensely coloured than standard colour solution Yw3 when compared as described under “Colour of liquids” (Vol. 1, p. 50).

Sulfated ash. Use 0.2 g; 0.32–0.40 g/g, with reference to the dried substance.

Loss on drying. Dry to constant mass at 60 °C under reduced pressure (not exceeding 0.5 kPa or about 5 mm of mercury) over phosphorus pentoxide R; it loses not more than 0.080 g/g.

pH value. pH of 10 mg/ml solution in carbon-dioxide-free water R, 5.5–8.0.

Assay. The anticoagulant activity of heparin is determined *in vitro* using a biological assay to compare its ability to delay the clotting of recalcified citrated sheep plasma with that of the reference substance. The following method is suitable for carrying out the assay (*other methods may also be applicable*).

The onset of clotting is determined either as a change in optical density (by direct visual inspection, preferably using indirect illumination against a matt black background, or by spectrophotometry, recording at a wavelength of approximately 600 nm) or as a change in fluidity (by visual detection while manually tilting the tube or by mechanical recording while stirring, taking care to cause the minimum disturbance of the solution during the initial phase of clotting). Use appropriate tubes according to the chosen technique.

Prepare a solution of Heparin calcium and a solution of heparin RS in sodium chloride (9 g/l) TS, each containing an accurately known number of IU of heparin per ml. Using sodium chloride (9 g/l) TS prepare from each solution a series of dilutions in geometric progression such that the clotting time obtained with the lowest concentration is not less than 1.5 times the blank recalcification time, and the clotting time obtained with the highest concentration is such as to give a satisfactory log dose–response curve, as determined in a preliminary test.

Place in an ice-bath 12 labelled tubes for each dilution: T₁, T₂, T₃, etc. for Heparin calcium and S₁, S₂, S₃, etc. for heparin RS. To each tube add 1.0 ml of

thawed plasma substrate R and 1.0 ml of the appropriate dilution, either from Heparin calcium or heparin RS, mixing each tube carefully, and not allowing bubbles to form. (The detection technique employed may require the addition of different volumes of plasma substrate, consequently the appropriate adjustment of all tubes would be needed.) Transfer all the tubes to a water-bath at 37°C, and allow to equilibrate for about 15 minutes. Add to each tube, mixing after each addition, 1 ml of a dilution of cephalin TS and 1 ml of kaolin suspension TS freshly prepared just before use. (A suitable dilution of cephalin TS is one that, under the conditions of the assay, gives a blank recalcification time of not more than 60 seconds.) After exactly 2 minutes, add 1.0 ml of calcium chloride (3.7 g/l) TS. Record in seconds the interval between this addition and the onset of clotting, determined according to the chosen technique. Similarly determine the blank recalcification time at the beginning and at the end of the procedure, using 1.0 ml of sodium chloride (9 g/l) TS in place of one of the heparin dilutions; the two values for the blank should not differ significantly. Repeat the procedure using fresh dilutions of the initial solutions and carrying out the incubation in the reverse order (first tubes S, then tubes T).

Transform the clotting times to logarithms using the mean values for the duplicate tubes and calculate the results by standard statistical methods.

Carry out not fewer than 3 independent assays. For each assay prepare fresh solutions of Heparin calcium and heparin RS, and use a different, freshly-thawed portion of the stored plasma substrate R.

Calculate the potency of Heparin calcium by combining the results of the assays by standard statistical methods. If the variance is significant ($P = 0.01$), due to differences between assays, it is possible to obtain a combined estimate by calculating the non-weighted mean of potency estimates.

The estimated potency is not less than 90% and not more than 111% of the stated potency. The fiducial limits of error of the estimated potency ($P = 0.95$) are not less than 80% and not more than 125% of the stated potency.

Additional requirements for Heparin calcium for parenteral use

Complies with the monograph for "Parenteral preparations" (see Vol. 4, p. 36).

Bacterial endotoxins. Carry out the test as described under "Test for bacterial endotoxins" (p. 30); Heparin calcium intended for the manufacture of a parenteral dosage form, without further appropriate procedure for the removal of bacterial endotoxins, contains not more than 0.01 IU of endotoxin RS per IU of heparin activity. The addition of divalent cations may be necessary in order to fulfil the validation criteria.

Heparinum natricum

Heparin sodium

Composition. Heparin sodium is a preparation containing the sodium salt of a sulfated glucosaminoglycan present in mammalian tissues. It has the characteristic property of delaying the clotting of fresh blood; CAS Reg. No. 9041-08-1.

Description. A white or almost white powder.

Solubility. Freely soluble in water.

Category. Anticoagulant.

Storage. Heparin sodium should be kept in a tightly closed container.

Labelling. The designation Heparin sodium for parenteral use indicates that the substance complies with the additional requirements and may be used for parenteral administration. The label should also state the name and quantity of any added substances, and the source of the material (lung or mucosal). Expiry date.

Additional information. Heparin sodium may be prepared from the lungs of oxen or the intestinal mucosae of oxen, pigs, or sheep. Attention should be paid to minimize or eliminate microbiological contamination and substances lowering blood pressure. Heparin sodium is moderately hygroscopic.

Requirements

Heparin sodium intended for the manufacture of a parenteral dosage form contains not less than **150IU per mg**, and Heparin sodium not intended for use in the manufacture of a parenteral dosage form contains not less than **120IU per mg**, both calculated with reference to the dried substance.

Identity tests

- A. Delays the clotting of fresh blood.
- B. Specific optical rotation, use a 40 mg/ml solution; $[\alpha]_{\text{D}}^{20^{\circ}\text{C}}$ is not less than $+35^{\circ}$.
- C. When tested for sodium as described under "General identification tests" (Vol. 1, p. 115) yields the characteristic reactions. If reaction B is to be used, prepare a 20 mg/ml solution.

Heavy metals. Use 0.5 g for the preparation of the test solution as described under “Limit test for heavy metals”, Procedure 3 (Vol. 1, p. 118); determine the heavy metals content according to Method A (Vol. 1, p. 119); not more than 30 µg/g.

Sodium. Determine by atomic absorption spectrophotometry (Vol. 1, p. 43) at a wavelength of 330.3 nm, using a sodium hollow cathode lamp and a flame of suitable composition (e.g. 11 litres of air and 2 litres of acetylene per minute). Prepare a solution of 5 mg in 10 ml of hydrochloric acid (0.1 mol/l) VS containing 1.27 mg/ml of caesium chloride R. As a reference solution use sodium standard (200 µg of Na per ml) TS and use dilutions containing 25, 50, and 75 µg of Na per ml in the same mixture of caesium chloride and hydrochloric acid as prepared above; 95–125 mg of Na per g, calculated with reference to the dried substance.

Nitrogen. Carry out Method A as described under “Determination of nitrogen” (Vol. 1, p. 136), using about 0.1 g, accurately weighed, and 5 ml of nitrogen-free sulfuric acid (~1760 g/l) TS. Each ml of sulfuric acid (0.05 mol/l) VS is equivalent to 1.401 mg of nitrogen; not more than 25 mg/g, with reference to the dried substance.

Protein and nucleotidic impurities. Measure the absorbance of a 1-cm layer of a 4 mg/ml solution at a wavelength of 260 nm and 280 nm; at 260 nm not greater than 0.20 and at 280 nm not greater than 0.15.

Clarity and colour of solution. A solution containing 5000 IU per ml is clear and not more intensely coloured than standard colour solution Yw3 when compared as described under “Colour of liquids” (Vol. 1, p. 50).

Sulfated ash. Use 0.2 g; 0.30–0.43 g/g, with reference to the dried substance.

Loss on drying. Dry to constant mass at 60 °C under reduced pressure (not exceeding 0.5 kPa or about 5 mm of mercury) over phosphorus pentoxide R; it loses not more than 0.080 g/g.

pH value. pH of 10 mg/ml solution in carbon-dioxide-free water R, 5.5–8.0.

Assay. The anticoagulant activity of heparin is determined *in vitro* using a biological assay to compare its ability to delay the clotting of recalcified citrated sheep plasma with that of the reference substance. The following method is suitable for carrying out the assay (*other methods may also be applicable*).

The onset of clotting is determined either as a change in optical density (by direct visual inspection, preferably using indirect illumination against a matt black background, or by spectrophotometry, recording at a wavelength of approximately 600 nm) or as a change in fluidity (by visual detection while

manually tilting the tube or by mechanical recording while stirring, taking care to cause the minimum disturbance of the solution during the initial phase of clotting). Use appropriate tubes according to the chosen technique.

Prepare a solution of Heparin sodium and a solution of heparin RS in sodium chloride (9 g/l) TS, each containing an accurately known number of IU of heparin per ml. Using sodium chloride (9 g/l) TS prepare from each solution a series of dilutions in geometric progression such that the clotting time obtained with the lowest concentration is not less than 1.5 times the blank recalcification time, and the clotting time obtained with the highest concentration is such as to give a satisfactory log dose–response curve, as determined in a preliminary test.

Place in an ice-bath 12 labelled tubes for each dilution: T₁, T₂, T₃, etc. for Heparin sodium and S₁, S₂, S₃, etc. for heparin RS. To each tube add 1.0 ml of thawed plasma substrate R and 1.0 ml of the appropriate dilution, either from Heparin sodium or heparin RS, mixing each tube carefully, and not allowing bubbles to be formed. (The detection technique employed may require the addition of different volumes of plasma substrate, consequently the appropriate adjustment of all tubes would be needed.) Transfer all the tubes to a water-bath at 37°C, and allow to equilibrate for about 15 minutes. Add to each tube, mixing after each addition, 1 ml of a dilution of cephalin TS and 1 ml of kaolin suspension TS freshly prepared just before use. (A suitable dilution of cephalin TS is one that, under the conditions of the assay, gives a blank recalcification time of not more than 60 seconds.) After exactly 2 minutes, add 1.0 ml of calcium chloride (3.7 g/l) TS. Record in seconds the interval between this addition and the onset of clotting, determined according to the chosen technique. Similarly determine the blank recalcification time at the beginning and at the end of the procedure, using 1.0 ml of sodium chloride (9 g/l) TS in place of one of the heparin dilutions; the two values for the blank should not differ significantly. Repeat the procedure using fresh dilutions of the initial solutions and carrying out the incubation in the reverse order (first tubes S, then tubes T).

Transform the clotting times to logarithms using the mean values for the duplicate tubes and calculate the results by standard statistical methods.

Carry out not fewer than 3 independent assays. For each assay prepare fresh solutions of Heparin sodium and heparin RS, and use a different, freshly-thawed portion of the stored plasma substrate R.

Calculate the potency of Heparin sodium by combining the results of the assays by standard statistical methods. If the variance is significant ($P = 0.01$), due to differences between assays, it is possible to obtain a combined estimate by calculating the non-weighted mean of potency estimates.

The estimated potency is not less than 90% and not more than 111% of the stated potency. The fiducial limits of error of the estimated potency ($P = 0.95$) are not less than 80% and not more than 125% of the stated potency.

Additional requirements for Heparin sodium for parenteral use

Complies with the monograph for "Parenteral preparations" (see Vol. 4, p. 36).

Bacterial endotoxins. Carry out the test as described under "Test for bacterial endotoxins" (p. 30); Heparin sodium intended for the manufacture of a parenteral dosage form, without further appropriate procedure for the removal of bacterial endotoxins, contains not more than 0.01 IU of endotoxin RS per IU of heparin activity. The addition of divalent cations may be necessary in order to fulfil the validation criteria.

Idoxuridinum

Idoxuridine

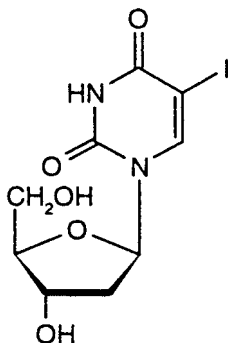

Relative molecular mass. 354.1

Chemical name. 2'-Deoxy-5-iodouridine; CAS Reg. No. 54-42-2.

Description. A white or almost white, crystalline powder.

Solubility. Slightly soluble in water, ethanol (~750 g/l) TS and hydrochloric acid (~70 g/l) TS; freely soluble in sodium hydroxide (~80 g/l) TS.

Category. Anti-infective agent.

Storage. Idoxuridine should be kept in a well-closed container, protected from light.

Labelling. The designation Idoxuridine for sterile non-injectable use indicates that the substance complies with the additional requirement and may be used for sterile applications. Expiry date.

Additional information. Melting temperature, about 180°C, with decomposition.

Requirements

Idoxuridine contains not less than **98.0%** and not more than **101.0%** of $C_9H_{11}N_2O_5$, calculated with reference to the dried substance.

Identity tests

- *Either test A alone or tests B, C, and D may be applied.*
- A. Carry out the examination as described under “Spectrophotometry in the infrared region” (Vol. 1, p. 40). The infrared absorption spectrum is concordant with the spectrum obtained from idoxuridine RS or with the *reference spectrum* of idoxuridine.
- B. Dissolve about 2 mg in 50 ml of sodium hydroxide (0.01 mol/l) VS; the absorption spectrum, when observed between 230 nm and 350 nm, exhibits a maximum at about 279 nm.
- C. See the test described below under “Related substances”. The principal spot obtained with solution D corresponds in position, appearance, and intensity to that obtained with solution E.
- D. Heat about 5 mg in a test-tube over an open flame; violet vapours are evolved.

Specific optical rotation. Use a 0.10 g/ml solution in sodium hydroxide (1 mol/l) VS and determine the rotation immediately after preparation. Calculate with reference to the dried substance; $[\alpha]_D^{20^\circ C} = +28^\circ$ to $+32^\circ$.

Iodine and iodide. For solution (A) dissolve 0.10 g in a mixture of 20 ml of water and 5 ml of sodium hydroxide (~80 g/l) TS, and immediately add 5 ml of sulfuric acid (~100 g/l) TS. Cool in an ice-bath, allow to stand for 10 minutes, shaking occasionally, and filter. For solution (B) dissolve 0.111 g of potassium iodide R in sufficient water to produce 1000 ml. To 1.0 ml of this solution add 19 ml of water, 5 ml of sodium hydroxide (~80 g/l) TS, and 5 ml of sulfuric acid (~100 g/l) TS, mix, and filter. Transfer both filtrates from solutions A and B to

separate comparison tubes, to each add 10 ml of dichloromethane R and 3 drops of potassium iodate (0.05 mol/l) VS, shake for 30 seconds, and allow to stand. The colour in the dichloromethane layer of solution A is not more intense than that produced with solution B when compared as described under “Colour of Liquids” (Vol. 1, p. 50).

Solution in alkali. A solution of 0.10 g in 10 ml of sodium hydroxide (1 mol/l) VS is clear and colourless.

Sulfated ash. Not more than 1.0 mg/g.

Loss on drying. Dry about 1 g to constant mass at 60°C under reduced pressure (not exceeding 0.6 kPa or about 5 mm of mercury) over phosphorus pentoxide R; it loses not more than 10 mg/g.

Related substances. Carry out the test as described under “Thin-layer chromatography” (Vol. 1, p. 83), using silica gel R4 as the coating substance and a mixture of 5 volumes of 2-propanol R, 4 volumes of dichloromethane R, and 1 volume of ammonia (~260 g/l) TS as the mobile phase. Apply separately to the plate 5 µl of each of 3 solutions in a mixture of 5 volumes of methanol R and 1 volume of ammonia (~260 g/l) TS containing (A) 40 mg of Idoxuridine per ml, (B) 0.20 mg of Idoxuridine per ml, (C) 0.10 mg of Idoxuridine per ml, (D) 4 mg of Idoxuridine per ml, and (E) 4 mg of idoxuridine RS per ml. After removing the plate from the chromatographic chamber, dry it in a current of cold air and repeat the development. After removing the plate following the second development from the chromatographic chamber, dry it in a current of cold air, and examine the chromatogram in ultraviolet light (254 nm).

Any spot obtained with solution A, other than the principal spot, is not more intense than that obtained with solution B (0.5%). Not more than 3 such spots are more intense than the spot obtained with solution C (0.25%).

Assay. Dissolve about 0.3 g, accurately weighed, in 50 ml of dimethylformamide R and titrate with tetrabutylammonium hydroxide (0.1 mol/l) VS as described under “Non-aqueous titration”, Method B (Vol. 1, p. 132), determining the end-point potentiometrically.

Each ml of tetrabutylammonium hydroxide (0.1 mol/l) VS is equivalent to 35.41 mg of C₉H₁₁IN₂O₅.

Additional requirement for sterile non-injectable Idoxuridine

Complies with the “Test for sterility of non-injectable preparations” (see page 32).

Isosorbidi dinitras dilutus

Diluted Isosorbide dinitrate

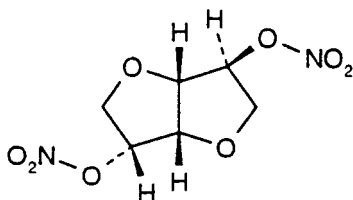

CAUTION: To permit safe handling, Isosorbide dinitrate is mixed with a suitable inert diluent, such as lactose or mannitol.

Appropriate precautions in handling undiluted Isosorbide dinitrate need to be observed, since it can explode if subjected to percussion or excessive heat. Only exceedingly small amounts should be isolated.

Relative molecular mass. 236.1

Chemical name. 1,4:3,6-Dianhydrosorbitol 2,5-dinitrate; CAS Reg. No. 87-33-2.

Description. Undiluted Isosorbide dinitrate is a fine, white, crystalline powder.

Solubility. Undiluted Isosorbide dinitrate is very slightly soluble in water; sparingly soluble in ethanol (~750 g/l) TS; very soluble in acetone R; freely soluble in dichloromethane R.

The solubility of the diluted product depends on the diluent and its concentration.

Category. Antianginal drug.

Storage. Diluted Isosorbide dinitrate should be kept in a tightly closed container, protected from light.

Labelling. The designation on the container should state the percentage content of Isosorbide dinitrate, $C_6H_8N_2O_8$.

Additional information. Diluted Isosorbide dinitrate may contain a suitable stabilizer, such as up to 1% of ammonium phosphate.

Requirements

Diluted Isosorbide dinitrate contains not less than **95.0%** and not more than **105.0%** of the amount of $C_6H_8N_2O_8$ stated on the label. It usually contains 20–50% of Isosorbide dinitrate.

Identity tests

- A. Carry out the examination as described under “Spectrophotometry in the infrared region” (Vol. 1, p. 40). The infrared absorption spectrum is concordant with the *reference spectrum* of isosorbide dinitrate. (*Instructions for the preparation of the spectrum will be given on the reference spectrum.*)
- B. Dissolve in a test-tube a quantity equivalent to 10 mg of Isosorbide dinitrate in a mixture of 1.0 ml of water and about 2.0 ml of sulfuric acid (~1760 g/l) TS and cool. Introduce slowly 3.0 ml of ferrous sulfate (15 g/l) TS to form two layers; a brown colour is formed at the interface of the two liquids.
- C. Shake a quantity equivalent to 25 mg of Isosorbide dinitrate with 10 ml of acetone R and filter. Evaporate the filtrate to dryness at a temperature not exceeding 40 °C and dry the residue under reduced pressure (not exceeding 0.6 kPa or about 5 mm of mercury) over phosphorus pentoxide R for 16 hours; melting point of the residue, about 71 °C.

Heavy metals. Use 1.0 g for the preparation of the test solution as described under “Limit test for heavy metals”, Procedure 3 (Vol. 1, p. 118); determine the heavy metals content according to Method B (Vol. 1, p. 119); not more than 10 µg/g.

Loss on drying. Dry at ambient temperature under reduced pressure (not exceeding 0.6 kPa or about 5 mm of mercury) over phosphorus pentoxide R for 16 hours; it loses not more than 10 mg/g.

Inorganic nitrates. Carry out the test as described under “Thin-layer chromatography” (Vol. 1, p. 83), using silica gel R3 as the coating substance and a mixture of 6 volumes of toluene R, 3 volumes of ethyl acetate R, and 1.5 volumes of glacial acetic acid R as the mobile phase. Apply separately to the plate 5 µl of each of the two following solutions. For solution (A) shake a quantity equivalent to 0.10 g of Isosorbide dinitrate in 5 ml of ethanol (~750 g/l) TS and filter. Solution (B) must be freshly prepared by dissolving 10 mg of potassium nitrate R in 1 ml of water and diluting to 100 ml with ethanol (~750 g/l) TS. After removing the plate from the chromatographic chamber, dry it in a current of air, and spray with freshly prepared potassium iodide/starch TS1. Expose the plate to ultraviolet light for 15 minutes. Examine the chromatogram in daylight.

Any spot corresponding to the nitrate ion obtained with solution A is not more intense than that obtained with solution B (0.5%, calculated as potassium nitrate).

Related substances. Carry out the test as described under “Thin-layer chromatography” (Vol. 1, p. 83), using silica gel R1 as the coating substance and a mixture of 8 volumes of toluene R and 2 volumes of ethyl acetate R as the mobile phase. Apply separately to the plate 20 µl of each of the following 2 solutions. For solution (A) shake a quantity equivalent to 0.20 g of Isosorbide dinitrate with 5 ml of acetone R and filter. For solution (B) dilute 1 volume of solution A to 200 volumes with acetone R. After removing the plate from the chromatographic chamber, dry it in a current of air, and spray with diphenylamine/sulfuric acid TS. Examine the chromatogram in daylight.

Any spot obtained with solution A, other than the principal spot, is not more intense than that obtained with solution B (0.5%).

Assay. Shake a quantity equivalent to about 25 mg of Isosorbide dinitrate, accurately weighed, with 15 ml of glacial acetic acid R for 15 minutes. Dilute with sufficient glacial acetic acid R to produce 25 ml and filter. To 1.0 ml of the filtrate add 2 ml of phenoldisulfonic acid TS, allow to stand for 15 minutes, add 50 ml of water, make alkaline with ammonia (~260 g/l) TS, cool, and add sufficient water to produce 100 ml (solution A). Prepare similarly a solution containing 0.20 g of potassium nitrate R, previously dried at 105 °C, in 5 ml of water and add sufficient glacial acetic acid R to produce 25 ml. To 5 ml of the resulting solution add sufficient glacial acetic acid R to produce 50 ml. To 1.0 ml of this solution add 2 ml of phenoldisulfonic acid TS, allow to stand for 15 minutes, add 50 ml of water, make alkaline with ammonia (~260 g/l) TS, cool, and add sufficient water to produce 100 ml (solution B).

Measure the absorbance of a 1-cm layer at the maximum at about 405 nm of solution A against a solvent cell containing solution B, and calculate the content of $C_6H_8N_2O_8$.

Each ml of the potassium nitrate solution is equivalent to 0.934 mg of $C_6H_8N_2O_8$.

Ketoconazolum

Ketoconazole

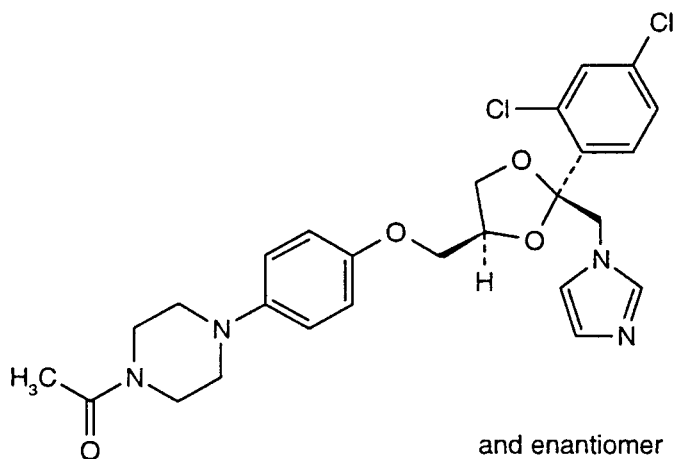

Relative molecular mass. 531.4

Chemical name. \pm -*cis*-1-Acetyl-4-[*p*-[2-(2,4-dichlorophenyl)-2-(imidazol-1-ylmethyl)-1,3-dioxolan-4-yl]methoxy]phenyl]piperazine; *cis*-1-acetyl-4-[4-[[2-(2,4-dichlorophenyl)-2-(1*H*-imidazol-1-ylmethyl)-1,3-dioxolan-4-yl]methoxy]phenyl]piperazine; *cis*-1-acetyl-4-[*p*-[2-(2,4-dichlorophenyl)-2-(1*H*-imidazol-1-ylmethyl)-1,3-dioxolan-4-yl]methoxy]phenyl]-piperazine; CAS Reg. No. 65277-42-1.

Description. A white or almost white powder.

Solubility. Practically insoluble in water; freely soluble in dichloromethane R; soluble in methanol R; sparingly soluble in ethanol (~750 g/l) TS.

Category. Antifungal drug.

Storage. Ketoconazole should be kept in a well-closed container, protected from light.

Requirements

Ketoconazole contains not less than **99.0%** and not more than the equivalent of **101.0%** of $\text{C}_{26}\text{H}_{28}\text{Cl}_2\text{N}_4\text{O}_4$, calculated with reference to the dried substance.

Identity tests

- Either test A alone or tests B, C, and D may be applied.

- A. Carry out the examination as described under “Spectrophotometry in the infrared region” (Vol. 1, p. 40). The infrared absorption spectrum is concordant with the spectrum obtained from ketoconazole RS or with the *reference spectrum* of ketoconazole.
- B. See the test described below under “Related substances”. The principal spot obtained with solution A corresponds in position, appearance, and intensity with that obtained with solution B.
- C. Place 1 ml of nitric acid (~1000 g/l) TS in a porcelain dish and add 10 mg of the substance; a clear orange-red solution is produced.
- D. Place 30 mg in a porcelain dish, add 0.3 g of anhydrous sodium carbonate R, and heat over an open flame for 10 minutes. Allow to cool, add 5 ml of nitric acid (~130 g/l) TS to the residue, stir, and filter. To 1 ml of the filtrate add 1 ml of water. The solution yields reaction A described under “General identification tests” as characteristic of chlorides (Vol. 1, p. 112).

Melting range. 148–152 °C.

Heavy metals. Use 1.0 g for the preparation of the test solution as described under “Limit test for heavy metals”, Procedure 3 (Vol. 1, p. 118); determine the heavy metals content according to Method A (Vol. 1, p. 119); not more than 20 µg/g.

Sulfated ash. Not more than 1.0 mg/g.

Loss on drying. Dry to constant mass at 105 °C; it loses not more than 5 mg/g.

Related substances. Carry out the test as described under “Thin-layer chromatography” (Vol. 1, p. 83), using silica gel R1 as the coating substance and a mixture of 4 volumes of dioxan R, 4 volumes of methanol R, and 2 volumes of ammonium acetate TS as the mobile phase. Apply separately to the plate 5 µl of each of 5 solutions in the mobile phase containing (A) 6 mg of Ketoconazole per ml, (B) 6 mg of ketoconazole RS per ml, for (C) prepare a mixture of 6 mg of each of ketoconazole RS and econazole nitrate RS per ml, (D) 30 µg of ketoconazole RS per ml, and (E) 15 µg of ketoconazole RS per ml. After removing the plate from the chromatographic chamber, allow it to dry in a current of warm air for 15 minutes. Expose the plate to iodine vapours until the spots appear and examine the chromatogram in daylight.

The test is not valid unless solution C shows two clearly separated spots. Any spot obtained with solution A, other than the principal spot, is not more intense than the principal spot obtained with solution D (0.5%) and only one such spot is more intense than that obtained with solution E (0.25%).

Assay. Dissolve about 0.2 g, accurately weighed, in 70 ml of a mixture of 1 volume of glacial acetic acid R1 and 7 volumes of ethylmethylketone R, and titrate with perchloric acid (0.1 mol/l) VS as described under “Non-aqueous titration”, Method A (Vol. 1, p. 131), determining the end-point potentiometrically.

Each ml of perchloric acid (0.1 mol/l) VS is equivalent to 26.57 mg of $C_{26}H_{28}Cl_2N_4O_4$.

Levamisoli hydrochloridum

Levamisole hydrochloride

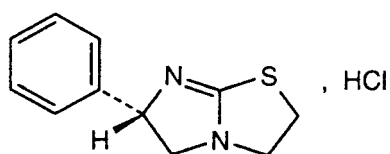

$C_{11}H_{12}N_2S, HCl$

Relative molecular mass. 240.8

Chemical name. (–)-2,3,5,6-Tetrahydro-6-phenylimidazo[2,1-*b*]thiazole monohydrochloride; (*S*)-2,3,5,6-tetrahydro-6-phenylimidazo[2,1-*b*]thiazole monohydrochloride; CAS Reg. No. 16595-80-5.

Description. A white or almost white, crystalline powder.

Solubility. Freely soluble in water; soluble in ethanol (~750 g/l) TS; slightly soluble in dichloromethane R.

Category. Anthelmintic drug.

Storage. Levamisole hydrochloride should be kept in a well-closed container, protected from light.

Requirements

Levamisole hydrochloride contains not less than **98.5%** and not more than **101.0%** of $C_{11}H_{12}N_2S, HCl$, calculated with reference to the dried substance.

Identity tests

- *Either tests A and D or tests B, C, and D may be applied.*

- A. Carry out the examination as described under “Spectrophotometry in the infrared region” (Vol. 1, p. 40). The infrared absorption spectrum is concordant with the spectrum obtained from levamisole hydrochloride RS or with the *reference spectrum* of levamisole hydrochloride.
- B. See the test described below under “Related substances”. The principal spot obtained with solution B corresponds in position, appearance, and intensity with that obtained with solution D.
- C. Dissolve about 0.06g in 20ml of water, add 2ml of sodium hydroxide (~80g/l) TS, boil for 10 minutes, and cool. Add a few drops of sodium nitroprusside (45g/l) TS; a red colour is produced which fades on standing.
- D. A 0.05g/ml solution yields reaction B described under “General identification tests” as characteristic of chlorides (Vol. 1, p. 112).

Specific optical rotation. Use a 0.050g/ml solution in carbon-dioxide-free water R and calculate with reference to the dried substance; $[\alpha]_{\text{D}}^{20^{\circ}\text{C}} = -121.5^{\circ}$ to -128° .

Clarity and colour of solution. A solution of 0.50g in 10ml of carbon-dioxide-free water R is clear and not more intensely coloured than standard colour Yw1 when compared as described under “Colour of liquids” (Vol. 1, p. 50).

Sulfated ash. Not more than 1.0mg/g.

Loss on drying. Dry to constant mass at 105°C; it loses not more than 5.0mg/g.

pH value. pH of a 0.05g/ml solution, 3.5–5.0.

Related substances. Carry out the test as described under “Thin-layer chromatography” (Vol. 1, p. 83), using silica gel R2 as the coating substance and a mixture of 60 volumes of toluene R, 40 volumes of acetone R, and 1 volume of ammonia (~260g/l) TS as the mobile phase. Apply separately to the plate 10µl of each of 4 solutions in methanol R containing (A) 50mg of Levamisole hydrochloride per ml, (B) 5.0mg of Levamisole hydrochloride per ml, (C) 0.25mg of Levamisole hydrochloride per ml, and (D) 5.0mg of levamisole hydrochloride RS per ml. After removing the plate from the chromatographic chamber, dry it at 105°C for 15 minutes, and examine the chromatogram in ultraviolet light (254nm).

Any spot obtained with solution A, other than the principal spot, is not more intense than that obtained with solution C (0.5%).

Expose the plate to iodine vapour in a tightly closed chamber for 15 minutes and examine the chromatogram in daylight.

Any spot obtained with solution A, other than any spot with a very low R_f value, is not more intense than that obtained with solution C (0.5%).

Assay. Dissolve about 0.2 g, accurately weighed, in 30 ml of ethanol (~750 g/l) TS and add 5 ml of hydrochloric acid (0.01 mol/l) VS. Titrate with sodium hydroxide (0.1 mol/l) VS, determining the two inflection points potentiometrically. Record the volume, in ml, of sodium hydroxide (0.1 mol/l) VS consumed between the two inflection points.

Each ml of sodium hydroxide (0.1 mol/l) VS is equivalent to 24.08 mg of $C_{11}H_{12}N_2S \cdot HCl$.

DL-Methioninum

DL-Methionine

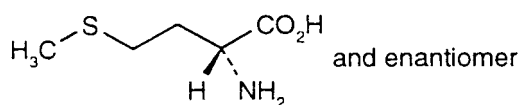

Relative molecular mass. 149.2

Chemical name. (*RS*)-2-Amino-4-(methylthio)butyric acid; CAS Reg. No. 59-51-8.

Description. An almost white, crystalline powder or small flakes.

Solubility. Sparingly soluble in water; very slightly soluble in ethanol (~750 g/l) TS. It dissolves in dilute acids and in dilute solutions of the alkali hydroxides.

Category. Antidote.

Storage. DL-Methionine should be protected from light.

Additional information. Melting temperature, about 270 °C.

Requirements

DL-Methionine contains not less than **99.0%** and not more than **101.0%** of $C_5H_{11}NO_2S$, calculated with reference to the dried substance.

Identity tests

- *Either tests A and D or tests B, C, and D may be applied.*
- A. Carry out the examination as described under “Spectrophotometry in the infrared region” (Vol. 1, p. 40). The infrared absorption spectrum is concordant with the spectrum obtained from DL-methionine RS or with the *reference spectrum* of DL-methionine.
- B. See the test described below under “Related substances”. The principal spot obtained with solution B corresponds in position, appearance, and intensity with that obtained with solution C.
- C. Dissolve together about 0.1 g of DL-Methionine with 0.1 g of glycine R in 4.5 ml of sodium hydroxide (~80 g/l) TS, add 1 ml of 25 mg/ml solution of sodium nitroprusside R, heat at 40 °C for 10 minutes, and allow to cool. Add 2 ml of a mixture of 1 volume of phosphoric acid (~1440 g/l) TS and 9 volumes of hydrochloric acid (~420 g/l) TS; a deep-red colour is produced.
- D. Use a 0.050 g/ml solution in hydrochloric acid (1 mol/l) VS and measure the angle of optical rotation as described under “Determination of optical rotation and specific rotation” (Vol. 1, p. 31); $[\alpha]_D^{20\text{ }^\circ\text{C}} = -0.05^\circ$ to $+0.05^\circ$.

Heavy metals. Use 1.0 g for the preparation of the test solution as described under “Limit test for heavy metals”, Procedure 3 (Vol. 1, p. 118); determine the heavy metals content according to Method A (Vol. 1, p. 119); not more than 20 µg/g.

Chlorides. Dissolve 1.2 g in a mixture of 5 ml of nitric acid (~130 g/l) TS and 35 ml of water, and proceed as described under “Limit test for chlorides” (Vol. 1, p. 116); the chloride content is not more than 0.2 mg/g.

Sulfates. Dissolve 1.0 g in 20 ml of water for injections R by heating to 60 °C, cool to 10 °C, and filter. Proceed with the filtrate as described under “Limit test for sulfates” (Vol. 1, p. 116); the sulfate content is not more than 0.2 mg/g.

Clarity and colour of solution. A solution of 0.20 g in 10 ml of carbon-dioxide-free water R is clear and colourless.

Sulfated ash. Not more than 1.0 mg/g.

Loss on drying. Dry to constant mass at 105 °C; it loses not more than 5.0 mg/g.

pH value. pH of a 20 mg/ml solution in carbon-dioxide-free water R, 5.4–6.1.

Related substances. Carry out the test as described under “Thin-layer chromatography” (Vol. 1, p. 83), using silica gel R1 as the coating substance and a mixture of 6 volumes of 2-butanol R, 2 volumes of glacial acetic acid R, and 2 volumes of water as the mobile phase. Apply separately to the plate 5 µl of each of 4 solutions containing (A) 20 mg of DL-Methionine per ml, (B) 0.40 mg of DL-Methionine per ml, (C) 0.40 mg of DL-methionine RS per ml, and (D) 0.040 mg of DL-methionine RS per ml. After removing the plate from the chromatographic chamber, allow it to dry in air, spray with triketohydrindene/butanol/acetic acid TS and heat at 105 °C for 15 minutes. Examine the chromatogram in daylight.

Any spot obtained with solution A, other than the principal spot, is not more intense than that obtained with solution D (0.2%).

Assay. Dissolve about 0.14 g, accurately weighed, in 3 ml of anhydrous formic acid R and add 30 ml of glacial acetic acid R1. Without delay titrate with perchloric acid (0.1 mol/l) VS as described under “Non-aqueous titration”, Method A (Vol. 1, p. 131), determining the end-point potentiometrically.

Each ml of perchloric acid (0.1 mol/l) VS is equivalent to 14.92 mg of C₅H₁₁NO₂S.

Methylrosanilini chloridum

Methylrosanilinium chloride

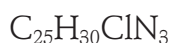
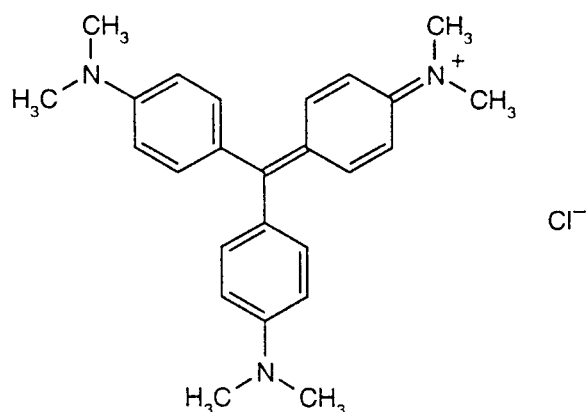

Relative molecular mass. 408.0

Chemical name. C.I. Basic violet 3; *N*-[4-[bis[4-(dimethylamino)phenyl]methylene]-2,5-cyclohexadien-1-ylidene]-*N*-methylmethanaminium chloride; CAS Reg. No. 548-62-9.

Other names. Crystal violet, gentian violet.

Description. A dark green powder or greenish, glistening pieces having a metallic lustre; odourless or almost odourless.

Solubility. Sparingly soluble in water; soluble in ethanol (~750 g/l) TS and glycerol R; practically insoluble in ether R.

Category. Anti-infective drug.

Storage. Methylrosanilinium chloride should be kept in a tightly closed container, protected from light.

Requirements

Methylrosanilinium chloride contains not less than **96.0%** and not more than the equivalent of **101.0%** of $C_{25}H_{30}ClN_3$, calculated with reference to the anhydrous substance.

Identity tests

- A. See the test described below under "Related substances". The principal spot obtained with solution A corresponds to the spot with the lowest R_f -value of the three distinct spots obtained with solution B. A spot other than the principal spot may be present on the chromatogram obtained with solution A; this other spot corresponds to the spot with intermediate R_f -value obtained with solution B.
- B. Dissolve about 20 mg in 10 ml of water and add 5 drops of hydrochloric acid (~420 g/l) TS. To 5 ml of this solution add tannic acid (50 g/l) TS, drop by drop; a blue precipitate is produced (keep the remaining solution for test C).
- C. To the remaining solution from test B add 0.5 g of zinc R powder, and warm the mixture; the solution discolours rapidly. Place on a filter-paper 1 drop of this solution adjacent to 1 drop of ammonia (~100 g/l) TS; a blue colour is produced at the zone of contact.

Ethanol-insoluble matter. Add 1.0 g to 50 ml of ethanol (~750 g/l) TS and boil under reflux for 15 minutes. Filter through a tared filtering crucible, wash the residue on the filter with hot ethanol (~750 g/l) TS until no violet colour appears

in the washings, and dry the crucible at 105 °C for 1 hour; the residue weighs not more than 10 mg (1.0%).

Sulfated ash. Not more than 15 mg/g.

Water. Determine as described under “Determination of water by the Karl Fischer method”, Method A (Vol. 1, p. 135), using 0.5 g of Methylrosanilinium chloride; the water content is not more than 0.075 g/g.

Related substances. Carry out the test as described under “Thin-layer chromatography” (Vol. 1, p. 83), using silica gel R2 as the coating substance and a mixture of 100 volumes of 1-butanol R, 5 volumes of ammonium chloride (20 g/l) TS, and 0.5 volume of formic acid (~1080 g/l) TS as the mobile phase. Apply separately to the plate 5 µl of each of 2 solutions in methanol R containing (A) 1 mg of Methylrosanilinium chloride per ml, and (B) 1 mg of methyl violet 2B R per ml; also apply to the plate 10 µl of each of 4 solutions in methanol R containing (C) 10 mg of Methylrosanilinium chloride per ml, (D) 2.5 mg of Methylrosanilinium chloride per ml, (E) 0.05 mg of 4,4'-bis(dimethylamino)benzophenone R per ml, and (F) 0.05 mg of Methylrosanilinium chloride per ml. After removing the plate from the chromatographic chamber, allow it to dry in air and examine the chromatogram in ultraviolet light (254 nm).

Any spot obtained with solution C corresponding to 4,4'-bis(dimethylamino)benzophenone is not more intense than that obtained with solution E (0.5%). Any spot obtained with solution D, other than the principal spot or any spot due to 4,4'-bis(dimethylamino)benzophenone, is not more intense than that obtained with solution F (2.0%).

Assay. Transfer about 0.4 g, accurately weighed, to a 300-ml conical flask, add 25 ml of water and 10 ml of hydrochloric acid (~420 g/l) TS. Replace the air in the flask with carbon dioxide R and maintain a stream of carbon dioxide R through the flask during the determination. Add 50.0 ml of titanium trichloride (0.1 mol/l) VS, heat to boiling, continuing to boil gently for 10 minutes, swirling the liquid occasionally. Cool, add 5 ml of ammonium thiocyanate (10 g/l) TS, and titrate with ferric ammonium sulfate (0.1 mol/l) VS until a faint red colour is produced. Repeat the procedure without the Methylrosanilinium chloride being examined and make any necessary corrections.

Each ml of titanium trichloride (0.1 mol/l) VS is equivalent to 20.40 mg of $C_{25}H_{30}ClN_3$.

Metronidazoli benzoas

Metronidazole benzoate

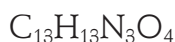
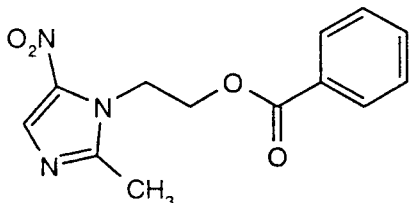

Relative molecular mass. 275.3

Chemical name. 2-(2-Methyl-5-nitro-1*H*-imidazol-1-yl)ethyl benzoate; 2-methyl-5-nitro-1*H*-imidazole-1-ethanol benzoate; CAS Reg. No. 13182-89-3.

Description. A white or slightly yellowish, crystalline powder.

Solubility. Practically insoluble in water; freely soluble in dichloromethane R; soluble in acetone R; slightly soluble in ethanol (~750 g/l) TS; very slightly soluble in ether R.

Category. Anti-infective drug.

Storage. Metronidazole benzoate should be kept in a well-closed container, protected from light.

Requirements

Metronidazole benzoate contains not less than **98.5%** and not more than **101.0%** of $\text{C}_{13}\text{H}_{13}\text{N}_3\text{O}_4$, calculated with reference to the dried substance.

Identity tests

- *Either tests A and D or tests B, C, and D may be applied.*
- A. Carry out the examination as described under “Spectrophotometry in the infrared region” (Vol. 1, p. 40). The infrared absorption spectrum is concordant with the spectrum obtained from metronidazole benzoate RS or with the *reference spectrum* of metronidazole benzoate.
- B. See the test described below under “Related substances”. The principal spot obtained with solution B corresponds in position, appearance, and intensity with that obtained with solution C.

C. To about 10 mg add 10 mg of zinc R powder, 1 ml of water, and about 0.3 ml of hydrochloric acid (~420 g/l) TS. Heat on a water-bath for 5 minutes and cool. The solution yields the reaction described for the identification of primary aromatic amines under "General identification tests" (Vol. 1, p. 111), producing a red precipitate.

D. Melting temperature, about 101 °C.

Heavy metals. Use 1.0 g for the preparation of the test solution as described under "Limit test for heavy metals", Procedure 3 (Vol. 1, p. 118); determine the heavy metals content according to Method A (Vol. 1, p. 119); not more than 20 µg/g.

Sulfated ash. Not more than 1.0 mg/g.

Loss on drying. Dry at 80 °C for 3 hours; it loses not more than 5.0 mg/g.

pH value. pH of a 20 mg/ml suspension in carbon-dioxide-free water R, 5.0–7.0.

Related substances. Carry out the test as described under "Thin-layer chromatography" (Vol. 1, p. 83), using silica gel R2 as the coating substance. Heat to activate the plate at 110 °C for 1 hour and cool before use. As the mobile phase, use ethyl acetate R. Apply separately to the plate 10 µl of each of 8 solutions in acetone R containing (A) 20 mg of Metronidazole benzoate per ml, (B) 2.0 mg of Metronidazole benzoate per ml, (C) 2.0 mg of metronidazole benzoate RS per ml, (D) 0.10 mg of Metronidazole benzoate per ml, (E) 0.040 mg of Metronidazole benzoate per ml, (F) 0.10 mg of metronidazole RS per ml, (G) 0.10 mg of 2-methyl-5-nitroimidazole R per ml, and for solution (H) dissolve 10 mg of metronidazole RS and 10 mg of 2-methyl-5-nitroimidazole R in sufficient acetone R to produce 50 ml. After removing the plate from the chromatographic chamber, allow it to dry in air, and examine the chromatogram in ultraviolet light (254 nm).

Any spot corresponding to metronidazole or to 2-methyl-5-nitroimidazole obtained with solution A is not more intense than the corresponding spot obtained with solutions F and G (0.5%). Any spot obtained with solution A, other than the principal spot and the spots corresponding to metronidazole and to 2-methyl-5-nitroimidazole, is not more intense than that obtained with solution D (0.5%), and not more than one such spot is more intense than that obtained with solution E (0.2%). The test is not valid unless the chromatogram obtained with solution H shows two clearly separated principal spots.

Assay. Dissolve about 0.25 g, accurately weighed, in 50 ml of glacial acetic acid R1, and titrate with perchloric acid (0.1 mol/l) VS as described under

“Non-aqueous titration”, Method A (Vol. 1, p. 131), determining the end-point potentiometrically.

Each ml of perchloric acid (0.1 mol/l) VS is equivalent to 27.53 mg of $C_{13}H_{13}N_3O_4$.

Nifedipinum

Nifedipine

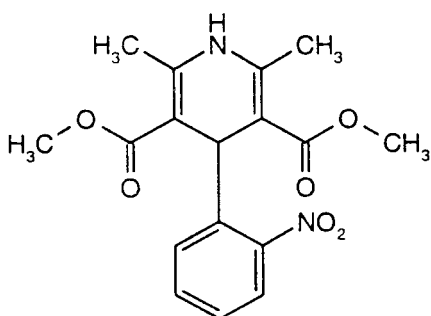

Relative molecular mass. 346.3

Chemical name. 1,4-Dihydro-2,6-dimethyl-4-(*o*-nitrophenyl)-3,5-pyridinedicarboxylate dimethyl ester; 1,4-dihydro-2,6-dimethyl-4-(2-nitrophenyl)-3,5-pyridinedicarboxylic acid dimethyl ester; CAS Reg. No. 21829-25-4.

Description. A yellow, crystalline powder.

Solubility. Nifedipine is practically insoluble in water; freely soluble in acetone R; sparingly soluble in dehydrated ethanol R.

Category. Cardiovascular drug; calcium-channel blocking agent.

Storage. Nifedipine should be kept in a tightly closed container, protected from light.

Additional information. *CAUTION:* Nifedipine decomposes on exposure to daylight, artificial light of certain wavelengths, and ultraviolet light.

Requirements

Nifedipine contains not less than **98.0%** and not more than **102.0%** of $C_{17}H_{18}N_2O_6$, calculated with reference to the dried substance.

Note: Throughout the monograph perform the tests and the assay in the dark or under a suitable fluorescent light, using low-actinic glassware.

Identity tests

- *Either tests A and D or tests B, C, and D may be applied.*
- A. Carry out the examination as described under “Spectrophotometry in the infrared region” (Vol. 1, p. 40). The infrared absorption spectrum is concordant with the spectrum obtained from nifedipine RS or with the *reference spectrum* of nifedipine.
- B. See the test described below under “Related substances, Test B”. The principal spot obtained with solution A corresponds in position, appearance, and intensity with that obtained with solution B.
- C. Using gentle heat dissolve 25 mg in 10 ml of a mixture of 5 volumes of ethanol (~750 g/l) TS, 3.5 volumes of water, and 1.5 volumes of hydrochloric acid (~420 g/l) TS. Add 0.5 g of granulated zinc R and allow to stand for 5 minutes, swirling occasionally, and filter. To the filtrate add 5 ml of sodium nitrite (10 g/l) TS and allow to stand for 2 minutes. Add 2.0 ml of ammonium sulfamate (50 g/l) TS, shake vigorously but carefully, and add 2.0 ml of *N*-(1-naphthyl)ethylenediamine hydrochloride (5 g/l) TS; an intense red colour is produced which does not fade within 5 minutes.
- D. Melting temperature, about 173 °C.

Sulfated ash. Use an ignition temperature of 600 °C; not more than 1.0 mg/g.

Loss on drying. Dry at 105 °C for 2 hours; it loses not more than 5.0 mg/g.

Related substances

- *Either test A or test B may be applied.*
- A. Carry out the test as described under “High-performance liquid chromatography” (p. 257), using a stainless steel column (15 cm × 4.6 mm) packed with *stationary phase A* (5–10 μm). As the mobile phase, use a mixture of 55 volumes of water, 36 volumes of methanol R, and 9 volumes of acetonitrile R.

Prepare the following solutions in methanol R: for solution (A) dissolve 0.20 g of Nifedipine in 20 ml of methanol R and dilute to 50 ml with the mobile phase; solution (B) 0.4 mg of dimethyl 2,6-dimethyl-4-(2-nitrophenyl)pyridine-3,5-dicarboxylate RS per ml; solution (C) 0.4 mg of dimethyl 2,6-dimethyl-4-(2-nitrosophenyl)pyridine-3,5-dicarboxylate RS

per ml; and for solution (D) mix 1.0 ml each of solutions B and C and 0.10 ml of solution A, dilute to 20 ml with the mobile phase, then dilute 2.0 ml of the resulting solution to 10 ml with the mobile phase.

Operate with a flow rate of 1.0 ml per minute. As a detector use an ultraviolet spectrophotometer set at a wavelength of about 235 nm; the use of an electronic integrator is advisable.

Inject 20 μ l of solution D. The peaks are eluted in the following order: dimethyl 2,6-dimethyl-4-(2-nitrophenyl)pyridine-3,5-dicarboxylate; dimethyl 2,6-dimethyl-4-(2-nitrosophenyl)pyridine-3,5-dicarboxylate; and nifedipine. The retention time of nifedipine is about 15.5 minutes.

The test is not valid unless, in the chromatogram obtained with solution D:

- the resolution between the peaks corresponding to dimethyl 2,6-dimethyl-4-(2-nitrophenyl)pyridine-3,5-dicarboxylate and dimethyl 2,6-dimethyl-4-(2-nitrosophenyl)pyridine-3,5-dicarboxylate is greater than 1.5; and
- the resolution between the peaks corresponding to dimethyl 2,6-dimethyl-4-(2-nitrosophenyl)pyridine-3,5-dicarboxylate and nifedipine is greater than 1.5.

Adjust the sensitivity of the system so that the height of the peak corresponding to dimethyl 2,6-dimethyl-4-(2-nitrophenyl)pyridine-3,5-dicarboxylate is not less than 20% of the full scale of the recorder.

Inject alternately 20 μ l each of solutions A and D. Record the chromatogram for twice the retention time of nifedipine.

Measure the areas of the peak responses obtained in the chromatograms from solutions A and D, and calculate the content of the related substances as a percentage. In the chromatogram obtained with solution A, none of the peaks, other than the principal peak and the peaks corresponding to dimethyl 2,6-dimethyl-4-(2-nitrophenyl)pyridine-3,5-dicarboxylate and dimethyl 2,6-dimethyl-4-(2-nitrosophenyl)pyridine-3,5-dicarboxylate, has an area greater than that of the peak corresponding to nifedipine in the chromatogram obtained with solution D (0.1%). The areas of the peaks corresponding to dimethyl 2,6-dimethyl-4-(2-nitrophenyl)pyridine-3,5-dicarboxylate and dimethyl 2,6-dimethyl-4-(2-nitrosophenyl)pyridine-3,5-dicarboxylate are not greater than the corresponding peaks in the chromatogram obtained with solution D (0.1%). The total amount of related substances does not exceed 0.3%. Disregard any peak with an area less than 10% of the area of the peak corresponding to nifedipine in the chromatogram obtained with solution D (0.01%).

- B. Carry out the test as described under "Thin-layer chromatography" (Vol. 1, p. 83), in an unsaturated chamber, using silica gel R6 as the coating substance and a mixture of 6 volumes of cyclohexane R and 4 volumes of ethyl acetate R as the mobile phase. Apply separately to the plate 5 μ l of each of 3 solutions in methanol R containing (A) 1.0 mg of Nifedipine per ml, (B) 1.0 mg of nifedipine RS per ml, and (C) 10 μ g of Nifedipine per ml. After removing the plate from the chromatographic chamber, allow it to dry in air, and examine the chromatogram in ultraviolet light (254 nm).

Any spot obtained with solution A, other than the principal spot, is not more intense than that obtained with solution C (1.0%).

Assay. Dissolve about 0.13 g, accurately weighed, in a mixture of 25 ml of *tert*-butanol R and 25 ml of perchloric acid TS, and titrate with ceric ammonium sulfate (0.1 mol/l) VS, using 0.1 ml of ferroin TS as indicator until the pink colour is discharged, titrating slowly towards the end-point. Repeat the procedure without the Nifedipine being examined and make any necessary corrections.

Each ml of ceric ammonium sulfate (0.1 mol/l) VS is equivalent to 17.32 mg of $C_{17}H_{18}N_2O_6$.

Nonoxinolum 9

Nonoxinol 9

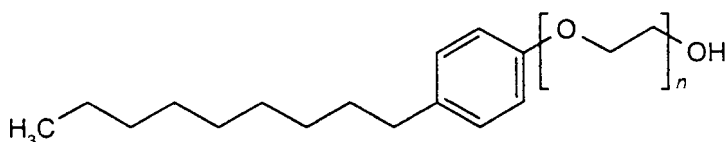

(Average value of $n = 9$, with a possible range of 4–16.)

Composition. Nonoxinol 9 is an anhydrous liquid mixture containing mainly monononylphenyl ethers of macrogols.

Chemical name. Polyethylene glycol mono(*p*-nonylphenyl) ether; α -(4-nonylphenyl)- ω -hydroxypoly-(oxy-1,2-ethanediyl); CAS Reg. No. 26027-38-3.

Description. A clear, colourless to light yellow, viscous liquid.

Solubility. Miscible with water, ethanol (~750 g/l) TS and olive oil R.

Category. Adjunctive contraceptive agent.

Storage. Nonoxinol 9 should be kept in a tightly closed container.

Additional information. Nonoxinol 9 should be kept away from oxidizing agents.

Requirements

The content is not less than **95.0%** and not more than **105.0%** of Nonoxinol 9, calculated with reference to the anhydrous substance.

Identity tests

- A. Carry out the examination as described under "Spectrophotometry in the infrared region" (Vol. 1, p. 40). The infrared absorption spectrum is concordant with the *reference spectrum* of nonoxinol 9.
- B. See the test described below under "Assay". The retention time of the major peak in the chromatogram obtained with solution A corresponds to that in the chromatogram obtained with solution B.

Acid value (Vol. 1, p. 140). Not more than 0.2.

Water. Determine as described under "Determination of water by the Karl Fischer method", Method A (Vol. 1, p. 135), using about 0.5 g of the substance; the water content is not more than 5.0 mg/g.

Macrogol. Transfer about 10 g, accurately weighed, to a 250-ml beaker. Add 100 ml of ethyl acetate R and allow to dissolve using a magnetic stirrer. Transfer to a 500-ml separatory funnel fitted with a glass stopper with the aid of 100 ml of sodium chloride (300 g/l) TS. Insert the stopper and shake vigorously for 1 minute. Remove the stopper carefully. Immerse a thermometer into the mixture and place the funnel so that it is partially immersed in a water-bath maintained at 50 °C. Swirl the funnel gently while letting the internal temperature rise to between 40 and 45 °C. Once this is reached remove the funnel from the bath immediately, dry the outside surface, and drain the aqueous layer into another 500-ml separatory funnel. Extract the organic layer with 100 ml of sodium chloride (300 g/l) TS a second time, combining the two aqueous extracts. Discard the organic layer. Wash the combined aqueous layers with 100 ml of ethyl acetate R and separate the aqueous layer into another 500-ml separatory funnel. Discard the organic layer. Extract the aqueous layer with two successive 100-ml portions of dichloromethane R, filtering the organic layers through a folded filter paper (e.g. grade Whatman 2V) and combining them in a 250-ml beaker. Evaporate to dryness on a water-bath and continue heating until the odour of dichloromethane is no longer perceptible. Allow the beaker

to cool. Add 25 ml of acetone R and allow the residue to dissolve using a magnetic stirrer. Filter into a tared 250-ml beaker, rinsing with two 25-ml quantities of acetone R. Evaporate to dryness on a water-bath. Dry under reduced pressure (not exceeding 0.6 kPa or about 5 mm of mercury) at 60 °C for 1 hour. Allow the beaker to cool, and weigh; not more than 16 mg/g.

Cloudiness of solution. Transfer 1.0 g to a 250-ml beaker, add 99 g of water, and mix to dissolve. Pour about 30 ml of the solution into a 70-ml test-tube. Place the test-tube into a water-bath and stir the contents constantly with a thermometer until the solution becomes cloudy, then immediately remove the test-tube from the bath, so that the temperature does not rise further by more than 2 °C, and continue stirring. The temperature at which the solution becomes sufficiently clear and when the entire thermometer bulb is clearly visible is between 52 and 56 °C.

Ethylene oxide and dioxan. Carry out the test as described under “Gas chromatography” (Vol. 1, p. 94), with the apparatus equipped with an injection system for the performance of head-space chromatography. Use a capillary glass or quartz column (30 m × 0.32 mm), the inner surface of which is coated with a thick layer of polydimethylsiloxane R (1.0 µm). Maintain the temperature of the column at 50 °C for 5 minutes. Increase the temperature at a rate of 5 °C per minute to 180 °C, and then increase the temperature again at a rate of 30 °C per minute to 230 °C, and maintain it at this point for 5 minutes. Maintain the temperature of the injection port at 150 °C and that of the detector at 250 °C. Use helium R or nitrogen R as the carrier gas with a linear velocity of about 20 cm per second and a split ratio of 1:20; use a flame-ionization detector.

Prepare the following solutions: for solution (A) weigh 1.0 g of Nonoxinol 9, add 1.0 ml of water, mix to obtain a homogeneous solution, and allow to stand at 70 °C for 45 minutes; for solution (B) weigh 1.0 g of Nonoxinol 9, add 0.5 ml of ethylene oxide TS and 0.5 ml of dioxan TS, mix to obtain a homogeneous solution, and allow to stand at 70 °C for 45 minutes; for solution (C) add to 0.5 ml of ethylene oxide TS 0.10 ml of a freshly prepared 10 mg/l solution of acetaldehyde R and 0.10 ml of dioxan TS, mix to obtain a homogeneous solution, and allow to stand at 70 °C for 45 minutes.

Inject 1.0 ml of the gaseous phase of solution C. Adjust the sensitivity of the system so that the heights of the peaks corresponding to ethylene oxide and acetaldehyde in the chromatogram obtained are at least 15% of the full scale of the recorder. The test is not valid unless the resolution between the peaks corresponding to acetaldehyde and ethylene oxide is at least 2.0 and the peak of ethylene oxide is detected with a signal-to-noise ratio of at least 5.

Inject separately 1.0 ml each of the gaseous phases of solutions A and B.

Measure the areas of the peak responses obtained in the chromatograms from solutions A and B. The mean areas of the ethylene oxide and dioxan peaks obtained with solution A are not greater than half the mean area of the corresponding peak obtained with solution B (1 µg/g of ethylene oxide and 50 µg/g of dioxan).

Assay. Determine by “High-performance liquid chromatography” (p. 257), using a stainless steel column (25 cm × 4 mm) packed with *stationary phase C*, the surface of which has been modified with chemically bonded dihydroxypropane groups (diol) (10 µm). As mobile phase A, use a mixture of 2 volumes of ethyl acetate R and 8 volumes of hexane R. As mobile phase B, use a mixture of 2.5 volumes of methanol R and 97.5 volumes of ethyl acetate R.

Prepare the following solutions in mobile phase A: solution (A) 2.0 mg of Nonoxinol 9 per ml; and solution (B) 2.0 mg of nonoxinol 9 RS per ml.

Operate with a flow rate of 1.0 ml per minute. As a detector use an ultraviolet spectrophotometer set at a wavelength of about 280 nm.

Use the following gradient elution system:

Time (minutes)	Mobile phase A (% v/v)	Mobile phase B (% v/v)	Comment
0–2	100	0	equilibration
2–10	100 → 84	0 → 16	linear gradient
10–20	84 → 70	16 → 30	linear gradient
20–30	70 → 62	30 → 38	linear gradient
30–40	62 → 57	38 → 43	linear gradient
40–50	57 → 54	43 → 46	linear gradient
50–70	54 → 50	46 → 50	linear gradient
70–75	50 → 50	50 → 50	isocratic
75–76	50 → 100	50 → 0	re-equilibration

Inject 100 µl each of solutions A and B. The nonoxinol oligomers elute as sharp distinct peaks, and their areas should be included in the peak response for nonoxinol 9.

Measure the areas of the peak responses obtained in the chromatograms from solutions A and B. The sum of the areas of any peaks corresponding to nonoxynols with chain lengths $n < 4$ or $n > 16$ is not greater than 1.0% of the sum of the areas of the peaks corresponding to nonoxynols with chain lengths $n = 4$ to $n = 16$. Calculate the content of Nonoxinol 9 as a percentage, with reference to the anhydrous substance.

Oxygenium

Oxygen

O₂

Relative molecular mass. 32.00

Chemical name. Oxygen; CAS Reg. No. 7782-44-7.

Description. A colourless gas; odourless.

Solubility. One volume dissolves in about 32 volumes of water and in about 7 volumes of ethanol (~750 g/l) TS, both at a pressure of 101.3 kPa and 20°C.

Category. Gas for inhalation.

Storage. Oxygen should be kept as compressed gas or liquid at cryogenic temperature, in appropriate containers complying with the safety regulations of the national authority.

Labelling. An ISO standard¹ requires that cylinders containing oxygen intended for medical use should bear the name of the contents in legible and permanent characters and, preferably, also the molecular formula O₂.

Additional information. In the analysis of medicinal gases certain tests are not intended for hospital pharmacists. They are solely applicable by laboratories equipped with the specialized apparatus.

Valves or taps should not be lubricated with oil or grease. It is recommended that cylinders marked as described above are not used for other gases.

Requirements

Oxygen contains not less than **99.5% v/v** of O₂.

Identity tests

- A. Place a glowing splinter of wood into Oxygen; the splinter bursts into flame.
- B. Shake Oxygen with alkaline pyrogallol TS; it is absorbed and the solution becomes dark brown (distinction from Dinitrogen oxide).

¹ *International Standard 32. Gas cylinders for medical use – marking for identification of content.* International Organization for Standardization, Switzerland, 1977.

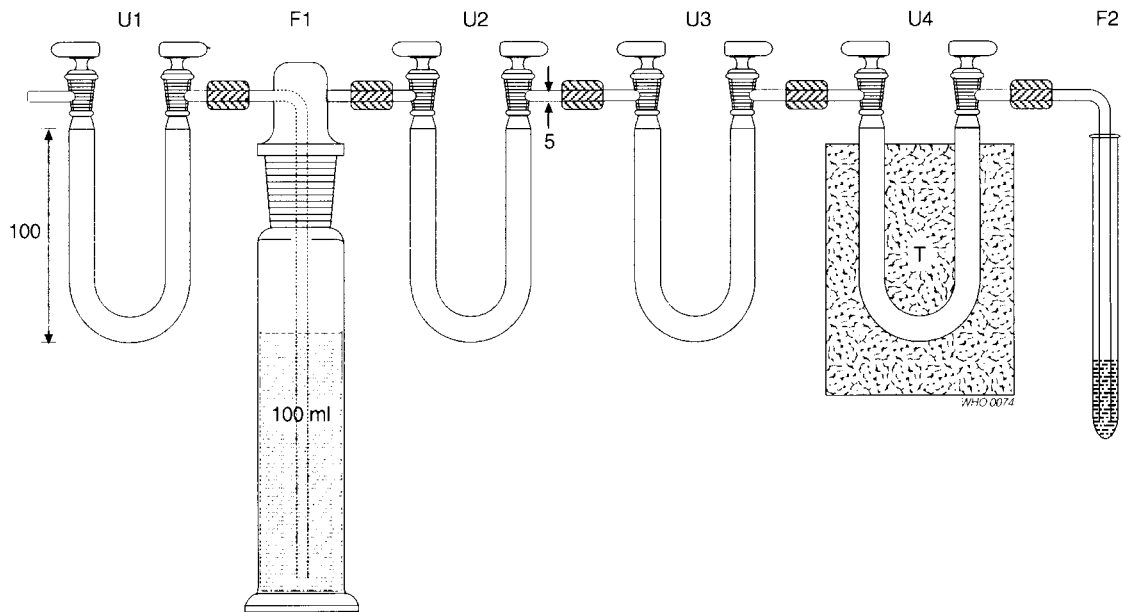

Figure 7. Apparatus for the determination of carbon monoxide in medicinal gases
Measurements in mm.

Reproduced with the permission of the European Pharmacopoeia Commission, European Directorate for the Quality of Medicines, Council of Europe.

- *Oxygen labelled as having been produced by the air-liquefaction process may be exempted from the requirements of the tests for carbon monoxide and carbon dioxide.*

Note: For the following tests deliver the gas to be examined at a rate of 4 litres per hour.

Carbon monoxide

- *Either test A or test B may be applied.*
- A. The apparatus (Fig. 7) consists of the following parts connected in series:
- a U-tube (U1) containing desiccant silica gel R impregnated with chromium trioxide R;
 - a wash bottle (F1) containing 100 ml of potassium hydroxide (~400 g/l) TS;
 - a U-tube (U2) containing pellets of potassium hydroxide R;
 - a U-tube (U3) containing phosphorus pentoxide R dispersed on previously granulated, fused pumice;
 - a U-tube (U4) containing 30 g of recrystallized iodine pentoxide R in granules, previously dried at 200 °C and kept at a temperature of 120 °C (T) during the test. The iodine pentoxide is packed in the tube in 1-cm columns separated by 1-cm columns of glass wool to give an effective length of 5 cm;

- a reaction tube (F2) containing 2.0 ml of potassium iodide (160 g/l) TS and 0.15 ml of starch TS.

Flush the apparatus with 5.0 litres of argon R. If necessary, discharge the blue colour in tube F2 containing potassium iodide (160 g/l) TS by adding a sufficient volume of freshly prepared sodium thiosulfate (0.002 mol/l) VS. Continue flushing with gas until not more than 0.045 ml of sodium thiosulfate (0.002 mol/l) VS is required after the passage of 5.0 litres of argon R. Pass 7.5 litres of Oxygen from the container through the apparatus. Flush the last traces of liberated iodine into the reaction tube by passing 1.0 litre of argon R through the apparatus. Titrate the liberated iodine with sodium thiosulfate (0.002 mol/l) VS. Repeat the procedure using 7.5 litres of argon R.

- B. Determine the content using a carbon monoxide detector tube. Pass the required volume of Oxygen through the tube, the calibration of which is verified according to the manufacturer's instructions.

The gas supply is connected to a pressure regulator and needle valve. Connect the flexible tubing fitted with a Y-piece to the valve and adjust the flow of Oxygen to purge the tubing to an appropriate flow. Fit the carbon monoxide detector tube to the metering pump following the manufacturer's instructions. Connect the open end of the tube to the short leg of the tubing and operate the pump sufficiently to pass a suitable volume of Oxygen through the tube. Read the value corresponding to the length of the coloured layer or the intensity of the colour on the graduated scale; not more than 5 µl/l.

Note: For the following tests – “Carbon dioxide”, “Oxidizing substances”, and “Acidity and alkalinity” – pass the gas to be tested through the appropriate reagent contained in a hermetically closed flat-bottomed glass cylinder (with dimensions such that 50 ml of liquid reaches a height of 12–14 cm) that is fitted with (a) a delivery tube terminated by a capillary 1 mm in internal diameter and placed within 2 mm of the bottom of the cylinder; and (b) an outlet tube.

Prepare the reference solutions in identical cylinders.

Carbon dioxide

- *Either test A or test B may be applied.*
- A. Pass 1.0 litre of Oxygen through 50 ml of a clear solution of barium hydroxide (0.15 mol/l) VS. Similarly prepare a reference solution by adding 1.0 ml of a 1.1 mg/ml solution of sodium hydrogen carbonate R in carbon-dioxide-free water R to 50 ml of barium hydroxide (0.15 mol/l) VS.

Any turbidity in the solution after the passage of the Oxygen is not more intense than that of the reference solution (300 µl/l).

- B. Determine the content using a carbon dioxide detector tube. Pass the required volume of Oxygen through the tube, the calibration of which is verified according to the manufacturer's instructions.

The gas supply is connected to a suitable pressure regulator and needle valve. Connect the flexible tubing fitted with a Y-piece to the valve and adjust the flow of Oxygen to purge the tubing to an appropriate flow. Fit the carbon dioxide detector tube to the metering pump following the manufacturer's instructions. Connect the open end of the tube to the short leg of the tubing and operate the pump sufficiently to pass a suitable volume of Oxygen through the tube. Read the value corresponding to the length of the coloured layer or the intensity of the colour on the graduated scale; not more than 300 µl/l.

Oxidizing substances. To two cylinders add 50 ml of freshly prepared potassium iodide/starch TS1 and about 0.2 ml of glacial acetic acid R. Protect the cylinders from light. Pass 5.0 litres of Oxygen into one of the solutions and compare the colour produced.

The solutions in both cylinders remain colourless.

Water

- *Either test A or test B may be applied.*
- A. The apparatus consists either of an electrolytic hygrometer as described below, an appropriate humidity detector tube, or a capacity hygrometer.

The measuring cell consists of a thin film of phosphoric anhydride placed between two coiled platinum wires that act as electrodes. The water vapour in Oxygen is absorbed by the phosphoric anhydride to form phosphoric acid, which acts as an electrical conductor.

Before introducing Oxygen into the device, allow the gas to stabilize at room temperature and make sure that the temperature is constant throughout the apparatus. Apply a continuous voltage across the electrodes to produce electrolysis of the water and regeneration of phosphoric anhydride. Measure the resulting electrical current, which is proportional to the water content in Oxygen. (This is a self-calibrating system that obeys Faraday's law.)

Calculate the content of water; not more than 60 µg/l.

- B. Determine the content using a water vapour detector tube. Pass the required volume of Oxygen through the tube, the calibration of which is verified according to the manufacturer's instructions.

The gas supply is connected to a pressure regulator and needle valve. Connect the flexible tubing fitted with a Y-piece to the valve and adjust the flow of Oxygen to purge the tubing to an appropriate flow. Fit the water vapour detector tube to the metering pump following the manufacturer's instructions. Connect the open end of the tube to the short leg of the tubing and operate the pump sufficiently to pass a suitable volume of Oxygen through the tube. Read the value corresponding to the length of the coloured layer or the intensity of the colour on the graduated scale; not more than 60 µl/l.

Acidity and alkalinity. Pass 2.0 litres of Oxygen through a mixture of 0.10 ml of hydrochloric acid (0.01 mol/l) VS and 50 ml of carbon-dioxide-free water R.

For *reference solution 1*, use 50 ml of carbon-dioxide-free water R. For *reference solution 2*, use a mixture of 0.20 ml of hydrochloric acid (0.01 mol/l) VS and 50 ml of carbon-dioxide-free water R.

To each solution add 0.1 ml of methyl red/ethanol TS; the intensity of the colour in the solution of Oxygen is between those of reference solutions 1 and 2.

Assay

- *Either method A or method B may be applied.*

A. For the determination use a 25-ml capacity gas burette (Fig. 8) in the form of a chamber with at its upper end, a tube graduated in 0.2% between 95 and 100, and isolated at each end by a tap with a conical barrel. The lower tap is joined to a tube with an olive-shaped nozzle and is used to introduce the Oxygen into the apparatus. A cylindrical funnel above the upper tap is used to introduce the absorbent solution. Wash the burette with water and dry. Open the two taps. Connect the nozzle to the container of Oxygen and set the flow rate to 1 litre per minute. Flush the burette by passing the gas through it for 1 minute. Close the upper tap of the burette and immediately afterwards the lower tap. Rapidly disconnect the burette from the container of Oxygen, and give a half turn to the upper tap to eliminate any excess pressure in the burette. Keeping the burette vertical, fill the funnel with a freshly prepared mixture of 21 ml of potassium hydroxide (~560 g/l) TS and 130 ml of sodium dithionite (200 g/l) TS. Open the upper tap slowly. The solution absorbs the oxygen and enters the burette. Allow to stand for 10 minutes without shaking.

Read the level of the liquid meniscus on the graduated part of the burette; the figure represents the content of oxygen as a percentage in v/v.

B. Oxygen in medicinal gases can also be determined using a paramagnetic analyser, which measures electronically the molecule's interaction with magnetic fields.

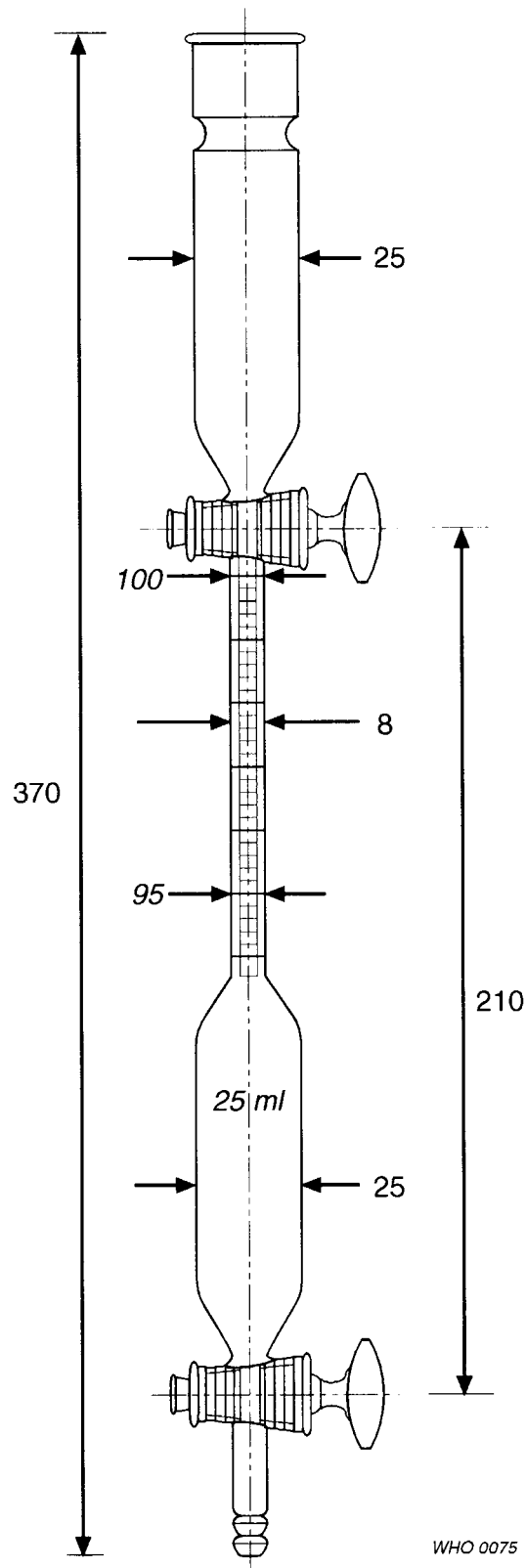

Figure 8. Burette used for the assay of oxygen
Measurements in mm.

Reproduced with the permission of the European Pharmacopoeia Commission, European Directorate for the Quality of Medicines, Council of Europe.

Carry out the method according to the instrument manufacturer's instructions.

Prednisoloni natrii phosphas

Prednisolone sodium phosphate

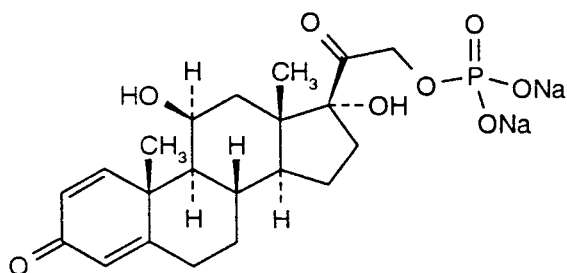

Relative molecular mass. 484.4

Chemical name. 11 β ,17,21-Trihydroxypregna-1,4-diene-3,20-dione 21-(disodium phosphate); (11 β) 11,17-dihydroxy-21-(phosphonooxy)-pregna-1,4-diene-3,20-dione disodium salt; CAS Reg. No. 125-02-0.

Description. A white to light yellow, crystalline powder or granules.

Solubility. Freely soluble in water; soluble in methanol R; very slightly soluble in ethanol (~750 g/l) TS and acetone R.

Category. Corticosteroid.

Storage. Prednisolone sodium phosphate should be kept in a tightly closed container, protected from light.

Labelling. The designation Prednisolone sodium phosphate for sterile non-injectable use indicates that the substance complies with the additional requirement and may be used for sterile applications. Expiry date.

Additional information. Prednisolone sodium phosphate is hygroscopic.

Requirements

Prednisolone sodium phosphate contains not less than **96.0%** and not more than **103.0%** of $C_{21}H_{27}Na_2O_8P$, calculated with reference to the anhydrous substance.

Identity tests

- Either tests A, D, and E or tests B, C, D, and E may be applied.
- A. Carry out the examination as described under “Spectrophotometry in the infrared region” (Vol. 1, p. 40). The infrared absorption spectrum is concordant with the spectrum obtained from prednisolone sodium phosphate RS or with the *reference spectrum* of prednisolone sodium phosphate.
- B. Carry out the test as described under “Thin-layer chromatography” (Vol. 1, p. 83), using silica gel R1 as the coating substance and a freshly prepared mixture of 3 volumes of 1-butanol R, 1 volume of acetic anhydride R, and 1 volume of water as the mobile phase. Apply separately to the plate 2 µl of each of 4 solutions in methanol R containing (A) 2.5 mg of Prednisolone sodium phosphate per ml, (B) 2.5 mg of prednisolone sodium phosphate RS per ml, (C) a mixture of equal volumes of solutions A and B, and (D) equal volumes of solution A and a solution of 2.5 mg of dexamethasone sodium phosphate RS per ml of methanol R. After removing the plate from the chromatographic chamber, allow it to dry in air until the solvents have evaporated, spray with a mixture of 10 ml of sulfuric acid (~1760 g/l) TS and 90 ml of ethanol (~750 g/l) TS, heat at 120 °C for 10 minutes, allow to cool, and examine the chromatogram in ultraviolet light (365 nm).

The principal spot obtained with solution A corresponds in position, appearance, and intensity with that obtained with solution B. The principal spot obtained with solution C appears as a single compact spot, whereas the chromatogram obtained with solution D shows two spots which may not be completely separated.

- C. To about 2 mg add 2 ml of sulfuric acid (~1760 g/l) TS and shake to dissolve; an intense red colour is produced within 5 minutes. Examine under ultraviolet light (365 nm); a reddish brown fluorescence is observed. Add the solution to 10 ml of water and mix; the colour fades and a greenish yellow fluorescence is produced.
- D. When tested for sodium as described under “General identification tests” (Vol. 1, p. 115), it yields the characteristic reactions. If reaction B is to be used, prepare a 20 mg/ml solution.
- E. To 1 ml of a 20 mg/ml solution add 3 ml of nitric acid (~130 g/l) TS; it yields reaction A described under “General identification tests” as characteristic of orthophosphates (Vol. 1, p. 114).

Specific optical rotation. Use a 10 mg/ml solution and calculate with reference to the anhydrous substance; $[\alpha]_{\text{D}}^{20^{\circ}\text{C}} = +95^{\circ}$ to $+102^{\circ}$.

Clarity and colour of solution. A solution of 0.5 g in 10 ml of carbon-dioxide-free water R is clear and not more intensely coloured than standard colour Bn1 when compared as described under “Colour of liquids” (Vol. 1, p. 50).

Water. Determine as described under “Determination of water by the Karl Fischer Method”, Method A (Vol. 1, p. 135), using about 0.2 g of the substance; not more than 0.080 g/g.

pH value. pH of a 0.05 g/ml solution in carbon-dioxide-free water R, 7.5–9.0.

Inorganic phosphates. Dissolve 0.050 g in sufficient water to produce 100 ml. To 10 ml add 5 ml of ammonium molybdate/vanadate TS, mix and allow to stand for 5 minutes; any yellow colour produced is not more intense than that of a reference solution prepared similarly using 10 ml of phosphate standard (5 µg/ml) TS.

Free prednisolone and other related substances

- *Either test A or test B may be applied.*

A. Carry out the test as described under “High-performance liquid chromatography” (p. 257), using a stainless steel column (15 cm × 4.6 mm) packed with *stationary phase A* (5 µm). As the mobile phase, use a mixture prepared as follows: weigh 1.36 g of potassium dihydrogen phosphate R and 0.60 g of hexylamine R, transfer to a 250-ml conical flask, mix, and allow to stand for 10 minutes, and then dissolve in 185 ml of water. Add 65 ml of acetonitrile R, mix, and filter.

Prepare the following solutions in the mobile phase: solution (A) 2.5 mg of Prednisolone sodium phosphate per ml; solution (B) 2.5 mg of prednisolone sodium phosphate RS and 2.5 mg of prednisolone RS per ml, dilute 1.0 ml of this solution to 25 ml with the mobile phase; and for solution (C) dilute 1.0 ml of solution A to 50 ml with the mobile phase.

Operate with a flow rate of 1.0 ml per minute. As a detector use an ultraviolet spectrophotometer set at a wavelength of 254 nm.

Inject 20 µl of solution B. Adjust the sensitivity of the system so that the heights of the principal peaks in the chromatogram obtained with solution B are 70–90% of the full scale of the recorder. The retention times for prednisolone sodium phosphate are about 6.5 minutes, and for prednisolone about 8.5 minutes. The test is not valid unless the resolution between the peaks corresponding to prednisolone sodium phosphate and prednisolone is not less than 4.5.

Inject alternately 20 µl each of solutions A and C. Continue the chromatography for 3 times the retention time of the principal peak.

Measure the areas of the peak responses obtained in the chromatograms from solutions A and C, and calculate the contents of free prednisolone and other related substances as a percentage. In the chromatogram obtained from solution A, the area of any peak, other than the principal peak, is not greater than that of the principal peak obtained with solution C (2.0%), and not more than one such peak has an area greater than half the area of the principal peak obtained with solution C (1.0%). The sum of the areas of all the peaks, other than the principal peak, is not greater than 1.5 times the area of the principal peak obtained with solution C (3.0%). Disregard any peak due to the solvent and any peak with an area less than 0.025 times the area of the principal peak obtained with solution C.

- B. Carry out the test as described under “Thin-layer chromatography” (Vol. 1, p. 83), using silica gel R1 as the coating substance and methanol R as the mobile phase. Apply separately to the plate 2 µl of each of 2 solutions in methanol R containing (A) 10 mg of Prednisolone sodium phosphate per ml, and (B) 0.20 mg of prednisolone RS per ml. After removing the plate from the chromatographic chamber, allow it to dry in air for 5 minutes, spray with a solution of 3 g of zinc chloride R in 10 ml of methanol R, heat at about 125 °C for 1 hour, and examine the chromatogram in ultraviolet light (365 nm).

Any spot obtained with solution A, other than the principal spot, is not more intense than that obtained with solution B (2.0%).

Assay. Dissolve about 0.1 g, accurately weighed, in sufficient water to produce 100 ml. Dilute 5 ml to 250 ml with water and measure the absorbance of this solution in a 1-cm layer at the maximum at about 247 nm.

Calculate the percentage content of $C_{21}H_{27}Na_2O_8P$ using the absorptivity value of 31.2 ($A_{1\text{cm}}^{1\%} = 312$).

Additional requirement for sterile non-injectable Prednisolone sodium phosphate

Complies with the “Test for sterility of non-injectable preparations” (see page 32).

Protamini sulfas

Protamine sulfate

Composition. Protamine sulfate is a mixture of sulfates of purified proteins extracted from the sperm or roe of fish usually belonging to the family *Clupidae* and *Salmonidae*; CAS Reg. No. 9009-65-8.

Description. A white or almost white powder; hygroscopic.

Solubility. Soluble in water; practically insoluble in ethanol (~750 g/l) TS and ether R.

Category. Drug affecting blood coagulation.

Storage. Protamine sulfate should be kept in a tightly closed and tamper-proof container.

Labelling. The designation Protamine sulfate for parenteral use indicates that the substance complies with the additional requirements and may be used for parenteral administration. Expiry date.

Additional information. Protamine sulfate binds with heparin in solution, inhibiting its anticoagulant activity. It is prepared in conditions designed to minimize the risk of microbial contamination.

Requirements

The quantity of **1 mg** of Protamine sulfate precipitates not less than **100 IU** of heparin sodium activity, calculated with reference to the dried substance.

Identity tests

- A. Use a 10 mg/ml solution in hydrochloric acid (0.1 mol/l) VS. Measure the optical rotation and calculate with reference to the dried substance; $[\alpha]_D^{20^\circ\text{C}} = -65^\circ$ to -85° .
- B. Dissolve 0.1 g in 5 ml of water, add 4.5 ml of water, 1.0 ml of sodium hydroxide (~80 g/l) TS, and 2.0 ml of 1-naphthol TS1. Cool the mixture to 5 °C and add 0.5 ml of sodium hypobromite TS; an intense red colour is produced.
- C. Dissolve 0.04 g in 2 ml of water and heat in a water-bath at 60 °C. Add 0.1 ml of mercuric sulfate TS and mix; no precipitate is formed. Cool the mixture in an ice-bath; a precipitate is formed.
- D. A 20 mg/ml solution yields reaction A described under “General identification tests” as characteristic of sulfates (Vol. 1, p. 115).

Heavy metals. Use 1.0 g for the preparation of the test solution as described under “Limit test for heavy metals”, Procedure 4 (Vol. 1, p. 119); determine the heavy metals content according to Method A (Vol. 1, p. 119); not more than 20 µg/g.

Sulfates. Transfer 0.15 g to a beaker and dissolve in 15 ml of water. Add 5 ml of hydrochloric acid (~70 g/l) TS, heat to boiling and slowly add to the boiling solution 10 ml of barium chloride (100 g/l) TS. Cover the beaker and heat in a water-bath for 1 hour. Filter, and wash the precipitate several times with small quantities of hot water. Dry and ignite the residue at 600 °C to constant mass. Each g of residue is equivalent to 0.412 g of sulfates (SO₄), calculated with reference to the dried substance; 0.16–0.24 g/g.

Clarity and colour of solution. A solution of 0.50 g in 10 ml of water is not more opalescent than opalescence standard TS2 and not more intensely coloured than standard colour solution Yw2 when compared as described under “Colour of liquids” (Vol. 1, p. 50).

Loss on drying. Dry at 105 °C for 3 hours; it loses not more than 0.050 g/g.

Light absorbance. Dissolve 0.050 g in 5 ml of water and measure the absorbance of a 1-cm layer at a wavelength between 260 nm and 280 nm; not greater than 0.1.

Nitrogen. Proceed as described under “Determination of nitrogen”, Method B (Vol. 1, p. 137), using 10 mg of Protamine sulfate; the content of nitrogen is not less than 0.23 g/g and not more than 0.27 g/g, calculated with reference to the dried substance.

Assay. Prepare the following solutions: for solution (A) dissolve 15.0 mg of Protamine sulfate in sufficient water to produce 100 ml; for solution (B) dilute 2.0 ml of solution A to 3.0 ml with water; for solution (C) dilute 1.0 ml of solution A to 3.0 ml with water.

As titrant use a solution of heparin RS in water containing about 170 IU/ml. Titrate each of solutions A, B, and C in duplicate and carry out 3 independent assays. Measure accurately 1.5 ml of one of the solutions and introduce it to a cell of a suitable spectrophotometer set at 420 nm. Add small volumes of the titrant until a sharp change in transmittance is observed and note the volume of titrant added.

For each individual titration, calculate the number of International Units of heparin in the volume of titrant added, per mg of Protamine sulfate. Average the 18 values and test the linearity of the response using the usual statistical methods. The assay is not valid unless the relative standard deviations calculated for the results obtained with each solution are less than 5% of the average result.

Additional requirements for Protamine sulfate for parenteral use

Complies with the monograph for "Parenteral preparations" (see Vol. 4, p. 36).

Bacterial endotoxins. Carry out the test as described under "Test for bacterial endotoxins (p. 30); contains not more than 7.0IU of endotoxin RS per mg.

Retinolum densatum oleosum

Retinol concentrate, oily form

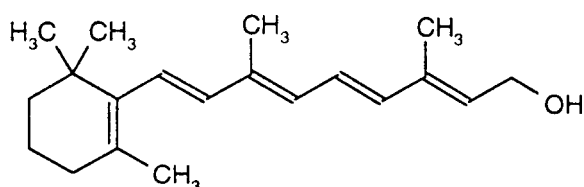

Composition. The oily form of Retinol concentrate consists of an ester or a mixture of esters (acetate, propionate, or palmitate) of retinol (C₂₀H₃₀O), usually prepared by synthesis. It may be diluted in a suitable vegetable oil.

Chemical name. 3,7 Dimethyl-9-(2,6,6-trimethyl-1-cyclohexen-1-yl)-2,4,6,8-nonatetraen-1-ol; CAS Reg. No. 68-26-8.

Other name. Vitamin A concentrate (oily form).

Description. A yellow to brownish yellow, oily liquid.

Solubility. Practically insoluble in water; soluble or partly soluble in dehydrated ethanol R; miscible with organic solvents.

Category. Vitamin.

Storage. The oily form of Retinol concentrate should be kept in a well-closed and well-filled container, protected from light, and stored at a temperature between 8 and 15 °C.

Labelling. The designation on the container should state the name of the ester or esters, whether any additional agents are added and their quantities, as well as the method of solubilizing the liquid if partial crystallization has occurred.

Additional information. Even in the absence of light, the oily form of Retinol concentrate is gradually degraded on exposure to a humid atmosphere, the decomposition being faster at higher temperatures.

Partial crystallization may occur in concentrated solutions and upon refrigeration. It may contain suitable antimicrobial agents and stabilizing agents such as antioxidants.

Requirements

The declared content of retinol is not less than **500 000 IU/g**. Retinol concentrate contains not less than **95.0%** and not more than **110.0%** of the amount of $C_{20}H_{30}O$ stated on the label.

Note: Once the container has been opened its contents should be used as soon as possible; any part of the contents not used at once should be protected by an atmosphere of inert gas.

Identity tests

A. Carry out the test as described under "Thin-layer chromatography" (Vol. 1, p. 83), using silica gel R1 as the coating substance and a mixture of 8 volumes of cyclohexane R and 2 volumes of ether R as the mobile phase. Apply separately to the plate 2 μ l of each of 4 solutions in cyclohexane R containing (A) 2 mg of Retinol per ml, (B) 2 mg of retinol acetate RS per ml, (C) 2 mg of retinol propionate RS per ml, and (D) 2 mg of retinol palmitate RS per ml. After removing the plate from the chromatographic chamber, allow it to dry in air, and spray with antimony trichloride TS. Examine the chromatogram in daylight.

The principal spot obtained with solution A corresponds to one or more of the spots obtained with solutions B, C, and D.

B. Dissolve a small drop in about 1 ml of dichloromethane R and add 5 ml of antimony trichloride TS; a blue colour is immediately produced which turns gradually to violet-red.

Acid value. Not more than 2.0.

Peroxides. For solution (A) dissolve 0.30 g in 25 ml of a mixture of 4 volumes of methanol R and 6 volumes of toluene R. For solution (B) prepare a solution containing 0.27 g of ferric chloride R per ml, and add 1.0 ml to 99 ml of a mixture of 4 volumes of methanol R and 6 volumes of toluene R. Dilute 2.0 ml to 100 ml with the same solvent mixture.

Place in 2 separate test-tubes in the following order, mixing after each addition, 3 ml of a solution containing 18 mg of ammonium thiocyanate R per ml, 10 ml

of methanol R, 0.3 ml of ferrous sulfate/hydrochloric acid TS, and 15 ml of toluene R. Then add 1.0 ml of solution A into one tube and 1.0 ml of solution B into the other, shake, and allow to stand for 5 minutes. The colour produced with solution A is not more intense than that produced with solution B.

Assay

Note: Carry out the assay as rapidly as possible, avoiding exposure to actinic light and oxidizing agents, and maintaining whenever possible an atmosphere of nitrogen above the solution.

The spectrophotometric measurements should be made at 20–25°C. Before each series of measurements, check the wavelength scale of the spectrophotometer as well as the absorbance scale (Vol. 1, p. 33). The cells filled with 2-propanol R must not differ from each other in absorbance by more than 0.002 at each of the following wavelengths: 300 nm, 325 nm, 350 nm, and 370 nm.

Carry out each determination in duplicate, using separately weighed amounts of Retinol concentrate. Prepare a dilution series containing 25–100 mg of Retinol concentrate in 5 ml of *n*-pentane R and dilute with 2-propanol R to a presumed concentration of 10–15 IU per ml. Verify that the absorption maximum of the solution to be examined, measured against a solvent cell containing 2-propanol R, lies between 325 nm and 327 nm. Measure the absorbances at 300 nm, 326 nm, 350 nm, and 370 nm. Repeat the readings at each wavelength and take the mean values. Calculate the ratio A_{λ}/A_{326} for each wavelength. If the ratios do not exceed 0.592 at 300 nm, 0.537 at 350 nm, and 0.142 at 370 nm, calculate the content of retinol in International Units per gram from the expression: $A_{326} \times V \times 1900/100m$, where A_{326} is the absorbance at 326 nm, V is the total volume used for the dilution to give 10–15 IU per ml, m is the mass of Retinol concentrate in g, and 1900 is the factor to convert the specific absorbances of ester of retinol into IU per g.

Selenii disulfidum

Selenium disulfide

SeS₂

Relative molecular mass. 143.1

Chemical name. Selenium sulfide; CAS Reg. No. 7488-56-4.

Description. A bright orange to reddish brown powder.

Solubility. Selenium disulfide is practically insoluble in water and organic solvents.

Category. Antifungal drug.

Storage. Selenium disulfide should be kept in a well-closed container.

Requirements

Selenium disulfide contains not less than **52.0%** and not more than **55.5%** of Se.

Identity tests

- A. Gently boil 0.05 g with 5 ml of nitric acid (~1000 g/l) TS for 30 minutes, dilute to 50 ml with water, and filter. To 5 ml of the filtrate add 10 ml of water and 5 g of urea R, boil, cool, and add 2.0 ml of potassium iodide (80 g/l) TS; a yellow to orange colour is produced which darkens rapidly on standing. (Keep this solution for test B.)
- B. Allow the coloured solution obtained in test A to stand for 10 minutes, and filter through kieselguhr R1. The filtrate yields the reactions described under "General identification tests" as characteristic of sulfates (Vol. 1, p. 115).

Sulfated ash. Not more than 2.0 mg/g.

Soluble selenium compounds. For solution A, use 10 g of Selenium disulfide, add 100 ml of water, mix well, allow to stand for 1 hour with frequent shaking, and filter. For solution B, use a solution of selenious acid R containing 5 µg of selenium per ml. To 10 ml of each of solutions A and B, add 2 ml of a solution containing about 1 ml of formic acid (~1080 g/l) TS in 10 ml of water, and dilute both solutions to 50 ml with water. If necessary, adjust the pH to 2.5 ± 0.5 with the diluted formic acid as prepared above. Then add 2.0 ml of freshly prepared 3,3'-diaminobenzidine tetrahydrochloride (5 g/l) TS, allow to stand for 45 minutes, and adjust the pH to 6.5 ± 0.5 with ammonia (~100 g/l) TS. Shake both solutions for 1 minute with 10 ml of toluene R, and allow to separate. Measure the absorbances of a 1-cm layer of the toluene layers at 420 nm against a solvent cell containing the same reagents treated as described above. The absorbance of solution A is not more than that of solution B (5 µg of Se per g).

Assay. To about 0.1 g, accurately weighed, add 25 ml of fuming nitric acid R, heat on a water-bath for 1 hour, cool, and dilute to 100 ml with water. To 25 ml of this solution add 50 ml of water and 5 g of urea R, and heat to boiling. Cool, add 7 ml of potassium iodide (80 g/l) TS, 3 ml of starch TS, and titrate immediately with sodium thiosulfate (0.1 mol/l) VS. Repeat the procedure

without the Selenium disulfide being examined and make any necessary corrections.

Each ml of sodium thiosulfate (0.1 mol/l) VS is equivalent to 1.974 mg of Se.

Sulfadiazinum argentum

Sulfadiazine silver

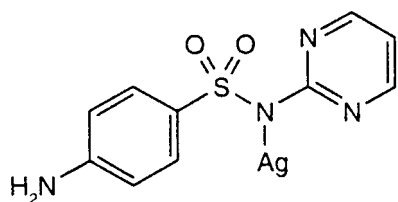

Relative molecular mass. 357.1

Chemical name. *N*¹-2-Pyrimidinylsulfanilamide monosilver(1+) salt; 4-amino-*N*-2-pyrimidinylbenzenesulfonamide monosilver(1+) salt; CAS Reg. No. 22199-08-2.

Description. A white or almost white, crystalline powder.

Solubility. Sulfadiazine silver is practically insoluble in water and ethanol (~750 g/l) TS; slightly soluble in acetone R and ether R; soluble in ammonia (~260 g/l) TS.

Category. Anti-infective drug.

Storage. Sulfadiazine silver should be kept in a well-closed container, protected from light.

Requirements

Sulfadiazine silver contains not less than **98.0%** and not more than **102.0%** of $\text{C}_{10}\text{H}_9\text{AgN}_4\text{O}_2\text{S}$, calculated with reference to the dried substance.

Identity tests

- *Either tests A and D or tests B, C, and D may be applied.*

Prepare the following residue to be used in tests A, B, and C: dissolve 0.5 g in 5 ml of nitric acid (~1000 g/l) TS, add 20 ml of water and 20 ml of sodium chloride (400 g/l) TS, mix, and filter. Neutralize the filtrate with sodium hydroxide (~80 g/l) TS using phenolphthalein/ethanol TS as indicator, and add 2.0 ml of acetic acid (~60 g/l) TS; a white precipitate is produced. Filter, wash the precipitate on the filter with water, and dry it at 105 °C for 1 hour.

- A. Carry out the examination with the residue as described under “Spectrophotometry in the infrared region” (Vol. 1, p. 40). The infrared absorption spectrum is concordant with the spectrum obtained from sulfadiazine RS or with the *reference spectrum* of sulfadiazine.
- B. About 10 mg of the residue yields the reaction described for the identification of primary aromatic amines under “General identification tests” (Vol. 1, p. 111), producing an orange-red precipitate.
- C. Dissolve about 0.1 g of the residue in 3 ml of water, add 3 ml of sodium hydroxide (50 g/l) TS, shake, and filter. To a portion of the filtrate add 1 drop of copper(II) sulfate (160 g/l) TS; a yellowish green precipitate is produced that on standing turns to brownish red.
- D. To about 0.1 g add 20 ml of water, 2 ml of nitric acid (~130 g/l) TS, and mix; a curdy, white precipitate is produced which is soluble in ammonia (~100 g/l) TS.

Loss on drying. Dry to constant mass at 80 °C; it loses not more than 5.0 mg/g.

pH value. Heat 1.0 g with 50 ml of carbon-dioxide-free water R to 70 °C for 5 minutes, cool rapidly, and filter. pH of the filtrate, 5.5–7.0.

Related substances. Carry out the test as described under “Thin-layer chromatography” (Vol. 1, p. 83), using silica gel R4 as the coating substance and a mixture of 7 volumes of dichloromethane R, 4 volumes of methanol R, and 1 volume of ammonia (~260 g/l) TS as the mobile phase. (*Note:* Mix the dichloromethane and methanol before adding the ammonia.) Apply separately to the plate 10 µl of each of the following 2 solutions. For solution (A) dissolve 50 mg of Sulfadiazine silver in 3.0 ml of ammonia (~260 g/l) TS and dilute with sufficient methanol R to produce 10 ml. For solution (B) dilute 1.0 ml of solution A with a mixture containing 4 volumes of methanol R and 1 volume of ammonia (~260 g/l) TS to produce 100 ml. Allow the spots to dry before development. After removing the plate from the chromatographic chamber, allow it to dry in air, and examine the chromatogram in ultraviolet light (254 nm).

Any spot obtained with solution A, other than the principal spot, is not larger and more intense than that obtained with solution B (1.0%).

Assay. Transfer into a stoppered flask about 0.5 g, accurately weighed, and dissolve in 8 ml of nitric acid (~130 g/l) TS. Add 50 ml of water and titrate with ammonium thiocyanate (0.1 mol/l) VS, using ferric ammonium sulfate (45 g/l) TS as indicator. Repeat the procedure without the Sulfadiazine silver being examined and make any necessary corrections.

Each ml of ammonium thiocyanate (0.1 mol/l) VS is equivalent to 35.71 mg of $C_{10}H_9AgN_4O_2S$.

Tropicamidum

Tropicamide

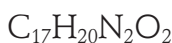
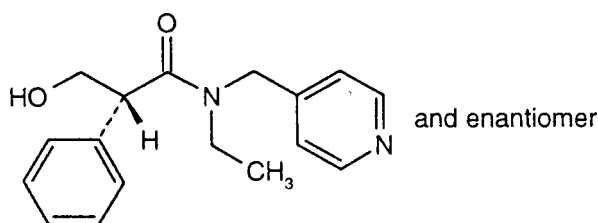

Relative molecular mass. 284.4

Chemical name. *N*-Ethyl-2-phenyl-*N*-(4-pyridylmethyl)hydracrylamide; *N*-ethyl- α -(hydroxymethyl)-*N*-(4-pyridinylmethyl)-benzeneacetamide; CAS Reg. No. 1508-75-4.

Description. A white or almost white, crystalline powder.

Solubility. Slightly soluble in water; freely soluble in dichloromethane R and ethanol (~750 g/l) TS.

Category. Mydriatic.

Storage. Tropicamide should be kept in a tightly closed container, protected from light.

Labelling. The designation Tropicamide for sterile non-injectable use indicates that the substance complies with the additional requirement and may be used for sterile applications. Expiry date.

Requirements

Tropicamide contains not less than **99.0%** and not more than **101.0%** of $C_{17}H_{20}N_2O_2$, calculated with reference to the dried substance.

Identity tests

- *Either test A alone or tests B, C, and D may be applied.*
- A. Carry out the examination as described under “Spectrophotometry in the infrared region” (Vol. 1, p. 40). The infrared absorption spectrum is concordant with the spectrum obtained from tropicamide RS or with the *reference spectrum* of tropicamide.
- B. The absorption spectrum of a 0.04 mg/ml solution in hydrochloric acid (0.1 mol/l) VS, when observed between 230 nm and 350 nm, exhibits a maximum at about 254 nm; the absorbance of a 1-cm layer at this wavelength is about 0.72.
- C. Dissolve 5 mg in 3 ml of a mixture of 9 ml of acetic anhydride R, 1 ml of acetic acid (~300 g/l) TS, and 0.10 g of citric acid R. Heat on a water-bath for 5–10 minutes: a reddish yellow colour is produced.
- D. Melting temperature, about 97 °C.

Sulfated ash. Not more than 1.0 mg/g.

Loss on drying. Dry at 80 °C under reduced pressure (not exceeding 0.6 kPa or about 5 mm of mercury) for 4 hours; it loses not more than 5.0 mg/g.

Tropic acid. To 10.0 mg add 5 mg of sodium tetraborate R and 0.35 ml of a freshly prepared solution containing 1.0 g of dimethylaminobenzaldehyde R in 10 ml of a mixture of 9 volumes of sulfuric acid (~1760 g/l) TS and 1 volume of water. Heat on a water-bath for 3 minutes. Cool in ice-water and add 5 ml of acetic anhydride R; no violet-red colour develops (0.05%).

Related substances. Carry out the test as described under “Thin-layer chromatography” (Vol. 1, p. 83), using silica gel R4 as the coating substance and a mixture of 95 volumes of dichloromethane R, 5 volumes of methanol R, and 0.5 volume of ammonia (~260 g/l) TS as the mobile phase. Apply separately to the plate 10 µl of each of 3 solutions in dichloromethane R containing (A) 20 mg of Tropicamide per ml, (B) 0.10 mg of Tropicamide per ml, and (C) 40 µg of Tropicamide per ml. After removing the plate from the chromatographic chamber, allow it to dry in air, and examine the chromatogram in ultraviolet light (254 nm).

Any spot obtained with solution A, other than the principal spot, is not more intense than that obtained with solution B (0.5%). Not more than one such spot is more intense than that obtained with solution C (0.2%).

Assay. Dissolve about 0.2 g, accurately weighed, in 50 ml of glacial acetic acid R1, and titrate with perchloric acid (0.1 mol/l) VS, using 1-naphtholbenzein/acetic acid TS as indicator until the colour changes from orange to green as described under “Non-aqueous titration”, Method A (Vol. 1, p. 131).

Each ml of perchloric acid (0.1 mol/l) VS is equivalent to 28.44 mg of $C_{17}H_{20}N_2O_2$.

Additional requirement for sterile non-injectable Tropicamide

Complies with the “Test for sterility of non-injectable preparations” (see page 32).

Monographs for
tablets

Allopurinoli compressi

Allopurinol tablets

Category. Drug used for the treatment of gout.

Additional information. Strength in the current WHO Model list of essential drugs: 100mg.

Requirements

Complies with the monograph for "Tablets" (see Vol. 4, p. 26).

Allopurinol tablets contain not less than **90.0%** and not more than **110.0%** of the amount of $C_5H_4N_4O$ stated on the label.

Identity tests

- *Either test A alone or tests B and C may be applied.*

A. Triturate a quantity of the powdered tablets equivalent to about 0.1 g of Allopurinol with 10 ml of sodium hydroxide (0.1 mol/l) VS. Filter, acidify the filtrate with acetic acid (~60 g/l) TS, and allow to stand for 10–15 minutes. Separate the precipitate, wash it with 3 ml of dehydrated ethanol R and 4 ml of ether R. Allow to dry in air for 15 minutes, then dry at 105 °C for 3 hours. Keep half of the residue for test C. Carry out the examination with the residue as described under "Spectrophotometry in the infrared region" (Vol. 1, p. 40). The infrared absorption spectrum is concordant with the spectrum obtained from allopurinol RS or with the *reference spectrum* of allopurinol.

B. The absorption spectrum of the solution obtained in the "Assay", when observed between 230 nm and 350 nm, exhibits a maximum at about 250 nm.

C. To the residue obtained in test A add 5 ml of sodium hydroxide (50 g/l) TS, 1.0 ml of alkaline potassiomeric iodide TS, heat to boiling, and allow to stand; a yellow precipitate is produced.

Related substances. Carry out the test as described under "Thin-layer chromatography" (Vol. 1, p. 83), using silica gel R4 as the coating substance and a mixture of 6 volumes of 2-butanol R, 2 volumes of ammonia (~260 g/l) TS, and 2 volumes of ethylene glycol monomethyl ether R as the mobile phase. Apply separately to the plate 10 µl of each of the following 2 solutions. For solution (A) shake a quantity of the powdered tablets equivalent to about 0.25 g of Allopurinol with a mixture of 1.0 ml of diethylamine R and 9 ml of water, filter, and use the filtrate. For solution (B) use 0.05 mg of aminopyrazole-4-

carboxamide hemisulfate RS per ml of ammonia (~260 g/l) TS. After removing the plate from the chromatographic chamber, allow it to dry in a current of air, and examine the chromatogram in ultraviolet light (254 nm).

Any spot obtained with solution A, other than the principal spot, is not more intense than that obtained with solution B.

Assay. Weigh and powder 20 tablets. To a quantity of the powder equivalent to about 0.1 g of Allopurinol add 20 ml of sodium hydroxide (0.05 mol/l) VS and shake for 20 minutes. Then add 80 ml of hydrochloric acid (0.1 mol/l) VS and shake for 10 minutes. Dilute to 250 ml with hydrochloric acid (0.1 mol/l) VS, filter, and dilute 10 ml of the filtrate to 250 ml with the same acid. Measure the absorbance of a 1-cm layer at the maximum at about 250 nm against a solvent cell containing hydrochloric acid (0.1 mol/l) VS.

Calculate the percentage content of $C_5H_4N_4O$ using the absorptivity value of 56.3 ($A_{1cm}^{1\%} = 563$).

Carbamazepini compressi

Carbamazepine tablets

Category. Antiepileptic agent.

Storage. Carbamazepine tablets should be kept in a tightly closed container.

Additional information. Strength in the current WHO Model list of essential drugs: 100 mg, 200 mg.

Requirements

Complies with the monograph for "Tablets" (Vol. 4, p. 26).

Carbamazepine tablets contain not less than **90.0%** and not more than **110.0%** of the amount of $C_{15}H_{12}N_2O$ stated on the label.

Identity tests

- *Either tests A and D or tests B, C, and D may be applied.*

Transfer a quantity of the powdered tablets equivalent to about 0.5 g of Carbamazepine to a 50-ml beaker, add 10 ml of warm acetone R, and shake. Filter while still warm, evaporate the filtrate to dryness on a water-bath, and dry at 80 °C. Dissolve in acetone R, allow to recrystallize, and use the crystals for the following tests.

- A. Carry out the examination with the crystals as described under “Spectrophotometry in the infrared region” (Vol. 1, p. 40). The infrared absorption spectrum is concordant with the spectrum obtained from carbamazepine RS or with the *reference spectrum* of carbamazepine.
- B. See the test described below under “Related substances”. The principal spot obtained with solution A corresponds in position, appearance, and intensity with that obtained with solution B.
- C. To about 0.1 g of the crystals add about 2 ml of nitric acid (~1000 g/l) TS and heat in a water-bath for 1 minute; an orange colour is produced.
- D. Melting temperature of the crystals, about 189 °C.

Related substances. Carry out the test as described under “Thin-layer chromatography” (Vol. 1, p. 83), using silica gel R1 as the coating substance and a mixture of 95 volumes of toluene R and 5 volumes of methanol R as the mobile phase. Apply separately to the plate 10 µl of each of the following 3 solutions. For solution (A) shake a quantity of the powdered tablets equivalent to about 0.20 g of Carbamazepine with three 10-ml quantities of chloroform R and filter. Evaporate the combined filtrates to dryness and dissolve the residue in 10 ml of chloroform R. For solution (B) use 20 mg of carbamazepine RS per ml of chloroform R. For solution (C) use 0.06 mg of iminodibenzyl R per ml of methanol R. After removing the plate from the chromatographic chamber, allow it to dry in air for 15 minutes, spray with potassium dichromate TS3, and examine the chromatogram in daylight.

Any spot obtained with solution A, other than the principal spot, is not more intense than that obtained with solution C.

Assay. Weigh and powder 20 tablets. To a quantity of the powder equivalent to about 0.06 g of Carbamazepine add 25 ml of ethanol (~750 g/l) TS and boil for a few minutes. Stir the hot mixture in a closed flask for 10 minutes and filter through a sintered glass filter. Wash the flask with ethanol (~750 g/l) TS, filter, and dilute the cooled filtrate with sufficient ethanol (~750 g/l) TS to produce 100 ml. Dilute 5 ml to 250 ml with the same solvent. Measure the absorbance of a 1-cm layer at the maximum at about 285 nm against a solvent cell containing ethanol (~750 g/l) TS.

Calculate the percentage content of $C_{15}H_{12}N_2O$ using the absorptivity value of 49.0 ($A_{1cm}^{1\%} = 490$).

Dissolution test. (See Preface, p. vii.)

Codeini phosphatis compressi

Codeine phosphate tablets

Category. Opioid analgesic, antidiarrhoeal, antitussive.

Additional information. Strength in the current WHO Model list of essential drugs: 30mg. Codeine phosphate tablets are prepared either from the hemihydrate or the sesquihydrate.

Requirements

Complies with the monograph for "Tablets" (see Vol. 4, p. 26).

Codeine phosphate tablets contain not less than **90.0%** and not more than **110.0%** of the amount of $C_{18}H_{21}NO_3 \cdot H_3PO_4$ stated on the label.

Identity tests

- *Either tests A and D or tests B, C, and D may be applied.*

A. To a quantity of the powdered tablets equivalent to about 0.1g of Codeine phosphate add 15ml of water and 5ml of sulfuric acid (~100g/l) TS, and allow to stand for 1 hour. Filter, if necessary, and wash any undissolved residue with a few ml of water. Render the filtrate alkaline with ammonia (~100g/l) TS and extract with several small portions of chloroform R. Evaporate the combined extracts to dryness on a water-bath and dry the residue at 80°C for 4 hours. Carry out the examination with the residue as described under "Spectrophotometry in the infrared region" (Vol. 1, p. 40). The infrared absorption spectrum is concordant with the spectrum obtained from the *reference spectrum* of codeine phosphate.

Shake a quantity of the powdered tablets equivalent to about 0.06g of codeine phosphate with four 10-ml portions of ethanol (~750g/l) TS and filter. Evaporate the combined filtrate to dryness on a water-bath and use the residue for the following tests.

- B. Dissolve 10mg of the residue in 5ml of sulfuric acid (~1760g/l) TS, add 1 drop of ferric chloride (25g/l) TS and, if necessary, heat gently; a violet-blue colour is produced. Add a few drops of nitric acid (~130g/l) TS; the colour changes to dark red.
- C. Dissolve 20mg of the residue in 1.0ml of water and add 1 drop of ferric chloride (25g/l) TS; a precipitate is formed but no blue tinge is observed in the solution (distinction from morphine).

D. Dissolve 10 mg of the residue in 2.0 ml of carbon-dioxide-free water R and add a few drops of silver nitrate (40 g/l) TS; a yellow precipitate is produced. Divide the solution with the precipitate into 2 portions. To 1 portion add a few drops of nitric acid (~130 g/l) TS; the precipitate dissolves to a clear solution. To the other portion add a few drops of ammonia (~100 g/l) TS and shake well; again the precipitate dissolves to a clear solution.

Assay. Weigh and powder 25 tablets. To a quantity of the powder equivalent to about 0.2 g of Codeine phosphate add sufficient water to produce a thin suspension, then add 20 ml of a mixture of 1 part of sulfuric acid (~100 g/l) TS and 3 parts of water. Shake occasionally over a period of 2 hours, then allow to stand for 12 hours, and filter. Add 5 ml of sodium hydroxide (~80 g/l) TS and extract with successive quantities of 15 ml, 10 ml, 10 ml, and 5 ml of chloroform R. Evaporate the combined extracts to dryness on a water-bath, dissolve the residue in 20 ml of glacial acetic acid R1, and titrate with perchloric acid (0.05 mol/l) VS as described under "Non-aqueous titration", Method A (Vol. 1, p. 131).

Each ml of perchloric acid (0.05 mol/l) VS is equivalent to 19.87 mg of $C_{18}H_{21}NO_3 \cdot H_3PO_4$.

Colchicini compressi

Colchicine tablets

Category. Drug used for the treatment of gout.

Additional information. Strength in the current WHO Model list of essential drugs: 500 µg.

Requirements

Complies with the monograph for "Tablets" (see Vol. 4, p. 26).

Colchicine tablets contain not less than **90.0%** and not more than **110.0%** of the amount of $C_{22}H_{25}NO_6$ stated on the label.

Identity tests

- *Either test A alone or tests B and C may be applied.*

A. Triturate a quantity of the powdered tablets equivalent to about 20 mg of Colchicine with 20 ml of water. Allow the solids to settle and filter the supernatant liquid into a separatory funnel. Shake with 30 ml of chloroform R. Evaporate the chloroform layer to dryness using mild heat. Carry out the

examination with the residue as described under "Spectrophotometry in the infrared region" (Vol. 1, p. 40). The infrared absorption spectrum is concordant with the spectrum obtained from colchicine RS or with the *reference spectrum* of colchicine.

- B. The absorption spectrum of the solution obtained in the "Assay", when observed between 230nm and 380nm, exhibits two maxima at about 243nm and 350nm. The ratio of the absorbance at 243nm to that at 350nm is between 1.80 and 2.00.
- C. Suspend a quantity of the powdered tablets in 1.5 ml of ethanol (~750 g/l) TS and filter. Place a few drops of the filtrate on a porcelain dish and evaporate to dryness on a water-bath. Mix the residue with 3 drops of sulfuric acid (~1760 g/l) TS; a lemon yellow colour is produced. Add 1 drop of nitric acid (~130 g/l) TS; the colour changes to greenish blue, turning rapidly to reddish, and finally becoming yellowish. Following this add about 0.5 ml of sodium hydroxide (~200 g/l) TS; the colour turns to red.

Related substances. Carry out the test as described under "Thin-layer chromatography" (Vol. 1, p. 83), using a suitable aluminium oxide R as the coating substance, containing a substance that fluoresces at about 254nm, and a mixture of 125 volumes of chloroform R, 100 volumes of acetone R, and 2 volumes of ammonia (~260 g/l) TS as the mobile phase. Apply separately to the plate 2µl of each of the following 2 solutions. For solution (A) shake a quantity of the powdered tablets equivalent to about 5 mg of Colchicine with 5 ml of chloroform R, filter, and evaporate the filtrate to dryness in a current of air. Dissolve the residue as completely as possible in about 0.1 ml of ethanol (~750 g/l) TS. Allow to settle and use the supernatant liquid. For solution (B) dilute 1 volume of solution A to 20 volumes with ethanol (~750 g/l) TS. After removing the plate from the chromatographic chamber, allow it to dry in air, and examine the chromatogram in ultraviolet light (254nm).

Any spot obtained with solution A, other than the principal spot, is not more intense than that obtained with solution B.

Assay

Note: The operations described below must be carried out in subdued light.

Weigh and powder 20 tablets. To a quantity of the powder equivalent to about 0.5 mg of Colchicine add 10 ml of dehydrated ethanol R and shake for 30 minutes. Centrifuge, separate, and wash the residue with dehydrated ethanol R. Combine the extract and washings and dilute to 50 ml with the same solvent. Measure the absorbance of a 1-cm layer at the maximum at about 350 nm against a solvent cell containing dehydrated ethanol R.

Calculate the percentage content of $C_{22}H_{25}NO_6$ using the absorptivity value of 42.5 ($A_{1\text{cm}}^{1\%} = 425$).

Uniformity of content

Note: The operations described below must be carried out in subdued light.

Place 1 tablet in a centrifuge tube and add 10 ml of dehydrated ethanol R. Crush the tablet to a fine powder, shake for 30 minutes, centrifuge, and wash the residue with dehydrated ethanol R. Combine the extract and washings and dilute to produce a solution of 0.01 mg/ml of dehydrated ethanol R. Measure the absorbance of a 1-cm layer at the maximum at about 350 nm against a solvent cell containing dehydrated ethanol R.

Calculate the tablet content of $C_{22}H_{25}NO_6$ in mg using the absorptivity value of 42.5 ($A_{1\text{cm}}^{1\%} = 425$). The tablets comply with the test for "Uniformity of content for single dose preparations" (Vol. 4, p. 46).

Dexamethasoni compressi

Dexamethasone tablets

Category. Adrenal hormone.

Additional information. Strength in the current WHO Model list of essential drugs: 500 µg, 4 mg.

Requirements

Complies with the monograph for "Tablets" (see Vol. 4, p. 26).

Dexamethasone tablets contain not less than **90.0%** and not more than **110.0%** of the amount of $C_{22}H_{29}FO_5$ stated on the label.

Identity tests

- *Either tests A and D or tests B, C, and D may be applied.*

To a quantity of the powdered tablets equivalent to about 20 mg of Dexamethasone add 50 ml of chloroform R and shake for 30 minutes. Filter, evaporate the filtrate to dryness, and dry the residue at 105 °C for 2 hours. Use the residue for the following tests.

A. Carry out the examination with the residue as described under "Spectrophotometry in the infrared region" (Vol. 1, p. 40). The infrared absorp-

tion spectrum is concordant with the spectrum obtained from dexamethasone RS or with the *reference spectrum* of dexamethasone.

- B. Carry out the test as described under “Thin-layer chromatography” (Vol. 1, p. 83), using kieselguhr R1 as the coating substance and a mixture of 9 volumes of acetone R and 1 volume of formamide R to impregnate the plate, dipping it about 5 mm into the liquid. After the solvent has reached a height of at least 16 cm, remove the plate from the chromatographic chamber and allow it to stand at room temperature until the solvent has completely evaporated. Use the impregnated plate within 2 hours, carrying out the chromatography in the same direction as the impregnation. Use chloroform R as the mobile phase. Apply separately to the plate 2 µl of each of 3 solutions in a mixture of 9 volumes of chloroform R and 1 volume of methanol R containing (A) 2.5 mg of the residue per ml, (B) 2.5 mg of dexamethasone RS per ml, and (C) a mixture of equal volumes of solutions A and B. Develop the plate for a distance of 15 cm. After removing the plate from the chromatographic chamber, allow it to dry in air until the solvents have evaporated, heat at 120 °C for 15 minutes, and spray the hot plate with sulfuric acid/ethanol TS. Heat at 120 °C for a further 10 minutes, allow to cool, and examine the chromatogram in daylight and in ultraviolet light (365 nm).

The principal spot obtained with solution A corresponds in position, appearance, and intensity with that obtained with solution B. A single spot is obtained with solution C.

- C. Transfer a solution containing about 0.2 mg of the residue in 2.0 ml of ethanol (~750 g/l) TS to a stoppered test-tube, add 10 ml of phenylhydrazine/sulfuric acid TS, mix, heat in a water-bath at 60 °C for 20 minutes, and cool immediately. The absorbance of a 1-cm layer at the maximum at about 423 nm is not less than 0.40.
- D. Transfer about 10 mg to a porcelain crucible, add 45 mg of magnesium oxide R, and ignite until an almost white residue is obtained. Allow to cool, add 2.0 ml of water, 0.05 ml of phenolphthalein/ethanol TS, and 1.0 ml of hydrochloric acid (~70 g/l) TS. Filter, to the filtrate add a freshly prepared mixture of 0.10 ml of sodium alzarinsulfonate (1 g/l) TS and 0.10 ml of zirconyl nitrate TS, mix, and allow to stand for 5 minutes. Repeat the test without the substance being examined. A yellow colour is produced in the solution of the substance being examined and the reagent blank turns red.

Assay. Weigh and powder 20 tablets. To a quantity of the powder equivalent to about 4.0 mg of Dexamethasone, add 15 ml of water, and shake with four quantities, each of 25 ml, of chloroform R. Filter the chloroform layers through cotton wool, previously washed with chloroform R, and add sufficient chloroform R to produce 200 ml. Transfer 10 ml of the resulting solution to a glass-

stoppered 50-ml conical flask, carefully evaporate to dryness, and dissolve the residue in 20 ml of dehydrated ethanol R. Add 2.0 ml of blue tetrazolium/ethanol TS and displace the air in the flask with oxygen-free nitrogen R. Immediately add 2.0 ml of tetramethylammonium hydroxide/ethanol TS and again displace the air with oxygen-free nitrogen R. Stopper the flask, mix the contents by gentle swirling, and allow to stand for 1 hour in a water-bath at 30 °C. Cool rapidly, add sufficient aldehyde-free ethanol (~750 g/l) TS to produce 25 ml, and mix. Measure the absorbance of a 1-cm layer at the maximum at about 525 nm against a solvent cell containing a solution prepared by treating 10 ml of aldehyde-free ethanol (~750 g/l) TS in a similar manner.

Calculate the percentage content of $C_{22}H_{29}FO_5$ by comparison with dexamethasone RS, similarly and concurrently examined.

Uniformity of content

To 1 tablet add 15 ml of water and shake until the tablet is completely disintegrated. Extract with four quantities of 1 ml of chloroform R, filter the chloroform layers through cotton wool, previously washed with chloroform R, and add sufficient chloroform R to produce 50 ml. Transfer a volume of this solution, equivalent to about 200 µg of Dexamethasone, to a glass-stoppered 50-ml conical flask, carefully evaporate to dryness, and dissolve the residue in 20 ml of dehydrated ethanol R. Add 2.0 ml of blue tetrazolium/ethanol TS and displace the air in the flask with oxygen-free nitrogen R. Immediately add 2.0 ml of tetramethylammonium hydroxide/ethanol TS and again displace the air with oxygen-free nitrogen R. Stopper the flask, mix the contents by gentle swirling, and allow to stand for 1 hour in a water-bath at 30 °C. Cool rapidly, add sufficient aldehyde-free ethanol (~750 g/l) TS to produce 25 ml, and mix. Measure the absorbance of a 1-cm layer at the maximum at about 525 nm against a solvent cell containing a solution prepared by treating 10 ml of aldehyde-free ethanol (~750 g/l) TS in a similar manner.

Calculate the tablet content of $C_{22}H_{29}FO_5$ in mg by comparison with dexamethasone RS, similarly and concurrently examined. The tablets comply with the test for "Uniformity of content for single dose preparations" (Vol. 4, p. 46).

Diloxanidi furoatis compressi

Diloxanide furoate tablets

Category. Antiamoebic drug.

Additional information. Strength in the current WHO Model list of essential drugs: 500 mg.

Requirements

Complies with the monograph for "Tablets" (see Vol. 4, p. 26).

Diloxanide furoate tablets contain not less than **90.0%** and not more than **110.0%** of the amount of $C_{14}H_{11}Cl_2NO_4$ stated on the label.

Identity tests

To a quantity of the powdered tablets equivalent to about 0.2 g of Diloxanide furoate add 20 ml of dichloromethane R and shake. Filter, evaporate the filtrate to dryness, and use the dried residue for the following tests.

- A. Carry out the examination with the residue as described under "Spectrophotometry in the infrared region" (Vol. 1, p. 40). The infrared absorption spectrum is concordant with the spectrum obtained from diloxanide furoate RS or with the *reference spectrum* of diloxanide furoate.
- B. Melting temperature of the residue, about 115°C.

Related substances. Carry out the test as described under "Thin-layer chromatography" (Vol. 1, p. 83), using silica gel R2 as the coating substance and a mixture of 96 volumes of dichloromethane R and 4 volumes of methanol R as the mobile phase. Apply separately to the plate 5 µl of each of the following 2 solutions. For solution (A) shake a quantity of the powdered tablets equivalent to about 0.5 g of Diloxanide furoate with 5 ml of chloroform R, centrifuge, and use the supernatant liquid. For solution (B) dilute 1 volume of solution A to 20 volumes of chloroform R, further dilute 1 volume of this solution to 20 volumes with the same solvent. After removing the plate from the chromatographic chamber, allow it to dry in air, and examine the chromatogram in ultraviolet light (254 nm).

Any spot obtained with solution A, other than the principal spot, is not more intense than that obtained with solution B.

Assay. Weigh and powder 20 tablets. To a quantity of the powder equivalent to about 0.04 g of Diloxanide furoate add 150 ml of ethanol (~750 g/l) TS and shake for 30 minutes. Add sufficient ethanol (~750 g/l) TS to produce 200 ml, mix, and filter. Dilute 10 ml of the filtrate to 250 ml with the same solvent. Measure the absorbance of a 1-cm layer at the maximum at about 258 nm against a solvent cell containing ethanol (~750 g/l) TS.

Calculate the percentage content of $C_{14}H_{11}Cl_2NO_4$ using the absorptivity value of 70.5 ($A_{1\text{cm}}^{1\%} = 705$).

Doxycyclini hyclatis compressi

Doxycycline hyclate tablets

Category. Antibacterial.

Storage. Doxycycline hyclate tablets should be kept in a tightly closed container.

Additional information. Strength in the current WHO Model list of essential drugs: 100 mg of doxycycline.

Requirements

Complies with the monograph for "Tablets" (see Vol. 4, p. 26).

Doxycycline hyclate tablets contain not less than **90.0%** and not more than **110.0%** of the amount of $C_{22}H_{24}N_2O_8$ stated on the label, if Assay method A is applied.

Identity tests

- *Either tests A and D or tests B, C, and D may be applied.*

A. Carry out the test as described under "Thin-layer chromatography" (Vol. 1, p. 83), using silica gel R3 as the coating substance. Adjust the pH of a solution of 0.1 g of disodium edetate R per ml to 9.0 with sodium hydroxide (~400 g/l) TS, and spray this evenly onto the plate. Allow the plate to dry in a horizontal position for not less than 1 hour. Just before use, dry the plate in an oven at 110°C for 1 hour. Use a mixture of 59 volumes of dichloromethane R, 35 volumes of methanol R, and 6 volumes of water as the mobile phase. Apply separately to the plate 1 µl of each of the following 3 solutions. For solution (A) shake a quantity of the powdered tablets equivalent to about 5 mg of Doxycycline hyclate with 5 ml of methanol R, filter, dilute the filtrate to 10 ml with the same solvent, and use the resulting solution. For solution (B) dissolve 5 mg of doxycycline hyclate RS in methanol R and dilute to 10 ml with the same solvent. For solution (C) dissolve 5 mg of doxycycline hyclate RS and 5 mg of tetracycline hydrochloride RS in methanol R, and dilute to 10 ml with the same solvent. After removing the plate from the chromatographic chamber, allow it to dry in a current of air, and examine the chromatogram in ultraviolet light (365 nm).

The principal spot obtained with solution A corresponds in position, appearance, and intensity with that obtained with solution B. The test is valid only if the chromatogram obtained with solution C shows two clearly separated spots.

- B. To a quantity of the powdered tablets equivalent to about 5 mg of Doxycycline hyclate add about 2 ml of sulfuric acid (~1760 g/l) TS; an intense yellow colour is produced.

To a quantity of the powdered tablets equivalent to about 0.1 g of Doxycycline hyclate add 10 ml of water, filter, and use the filtrate for the following tests.

- C. To 2.0 ml of the filtrate add 1 drop of ferric chloride (25 g/l) TS; a dark red-brown colour is produced.
- D. To 1.0 ml of the filtrate add 5 drops of silver nitrate (40 g/l) TS; a white, curdy precipitate is formed which dissolves in 1.0 ml of ammonia (~100 g/l) TS.

Light-absorbing impurities. To a quantity of the powdered tablets equivalent to about 0.10 g of Doxycycline hyclate add 10 ml of a mixture of 1 volume of hydrochloric acid (1 mol/l) VS and 99 volumes of methanol R, shake, and filter, discarding the first 2 ml of filtrate. Measure the absorbance of a 1-cm layer at 490 nm; the absorbance does not exceed 0.2.

Assay

- *Either method A or method B may be applied.*

- A. Carry out the test as described under “High-performance liquid chromatography” (p. 257), using a stainless steel column (25 cm × 4.6 mm) packed with *stationary phase D* (8–10 μm). As the mobile phase, use a solution prepared as follows: transfer 60.0 g of *tert*-butanol R with the aid of 200 ml of water to a 1000-ml volumetric flask. Add 400 ml of buffer borate, pH 8.0, TS, 50 ml of a solution of 10 mg of tetrabutylammonium hydrogen sulfate R per ml adjusted to pH 8.0 with sodium hydroxide (~80 g/l) TS, and 20 ml of sodium edetate (20 g/l) TS adjusted to pH 8.0 with sodium hydroxide (~80 g/l) TS. Dilute to 1000 ml with water.

Prepare the following solutions in hydrochloric acid (0.01 mol/l) VS: solution (A) 0.80 mg of Doxycycline hyclate per ml; solution (B) 0.80 mg of doxycycline hyclate RS per ml; solution (C) 0.80 mg of 6-epidoxycycline hydrochloride RS per ml; solution (D) 0.80 mg of metacycline hydrochloride RS per ml; for solution (E) mix 4.0 ml of solution B with 1.5 ml of solution C and 1.0 ml of solution D, and dilute to 25 ml with hydrochloric acid (0.01 mol/l) VS; and for solution (F) mix 2.0 ml of solution C and 2.0 ml of solution D and dilute to 100 ml with hydrochloric acid (0.01 mol/l) VS.

Operate with a flow rate of about 0.9 ml per minute. As a detector use an ultraviolet spectrophotometer set at a wavelength of about 254 nm.

Inject 20 µl of solution E. The test is not valid unless the resolution between the first peak (metacycline) and the second peak (6-epidoxycycline) is not less than 1.25, and the resolution between the second peak and the third peak (doxycycline) is not less than 2.0. If necessary, adjust the *tert*-butanol R content in the mobile phase. The test is not valid unless the symmetry factor for the third peak is not more than 1.25. If necessary adjust the integrator parameters.

Inject alternately 20 µl each of solutions A and B.

Measure the areas of the peak responses obtained in the chromatograms from solutions A and B, and calculate the percentage content of $C_{22}H_{24}N_2O_8$ in the tablets, taking into account the declared content of $C_{22}H_{24}N_2O_8$ in doxycycline hyclate RS.

- B. Weigh and powder 20 tablets. To a quantity of the powder equivalent to about 50 mg, accurately weighed, add 50 ml of dimethylformamide R and shake for 1 hour. Centrifuge, and carry out the assay with the supernatant liquid as described under "Microbiological assay of antibiotics" (Vol. 1, p. 145), using *Bacillus cereus* (NCTC 10320 or ATCC 11778) as the test organism, culture medium Cm10 with a final pH of 6.6, potassium dihydrogen phosphate (13.6 g/l) TS as the buffer, an appropriate concentration of Doxycycline (usually between 0.2 and 2.0 IU per ml), and an incubation temperature of 35–39 °C. The precision of the assay is such that the fiducial limits of error of the estimated potency ($P = 0.95$) are not less than 95% and not more than 105%. The upper fiducial limit of error is not less than 97.0% and the lower fiducial limit of error is not more than 110.0% of the content stated on the label expressed in mg, with 870 IU being equivalent to 1 mg of doxycycline.

Dissolution test. (See Preface, p. vii.)

Erythromycini ethylsuccinatis compressi

Erythromycin ethylsuccinate tablets

Category. Antibacterial.

Storage. Erythromycin ethylsuccinate tablets should be kept in a tightly closed container.

Additional information. Strength in the current WHO Model list of essential drugs: 250 mg of erythromycin.

Requirements

Complies with the monograph for "Tablets" (see Vol. 4, p. 26)

Identity tests

- Either test A alone or tests B, C, and D may be applied.

To a quantity of the powdered tablets equivalent to about 0.25 g of Erythromycin ethylsuccinate add 20 ml of chloroform R and shake. Filter, evaporate the filtrate to dryness, and use the dried residue for tests A, C, and D.

- A. Carry out the examination with the residue as described under "Spectrophotometry in the infrared region" (Vol. 1, p. 40). The infrared absorption spectrum is concordant with the spectrum obtained from erythromycin ethylsuccinate RS or with the *reference spectrum* of erythromycin ethylsuccinate.
- B. Carry out the test as described under "Thin-layer chromatography" (Vol. 1, p. 83), using silica gel R1 as the coating substance and a mixture of 85 volumes of methanol R and 15 volumes of chloroform R as the mobile phase. Apply separately to the plate 10 μ l of each of the following 2 solutions. For solution (A) shake a quantity of the powdered tablets equivalent to about 30 mg of Erythromycin ethylsuccinate with 10 ml of methanol R by mechanical means for 30 minutes. Centrifuge a portion of this mixture and use the clear supernatant liquid. For solution (B) use 3 mg of erythromycin ethylsuccinate RS per ml of methanol R. After removing the plate from the chromatographic chamber, allow it to dry in a current of air, and spray with a mixture of 90 volumes of dehydrated ethanol R, 5 volumes of anisaldehyde R, and 5 volumes of sulfuric acid (~1760 g/l) TS. Heat the plate at 100°C for 10 minutes and examine the chromatogram in daylight.

The principal spot obtained with solution A corresponds in position, appearance, and intensity with that obtained with solution B.

- C. To 5 mg of the residue add about 2 ml of sulfuric acid (~1760 g/l) TS and shake gently; a reddish brown colour is produced.
- D. Dissolve about 3 mg of the residue in 2.0 ml of acetone R and add about 2 ml of hydrochloric acid (~420 g/l) TS; an orange colour is produced, which changes to orange-red and finally to violet-red. Add 2.0 ml of chloroform R and shake; the chloroform layer turns to blue.

Assay. Weigh and powder 20 tablets. To a quantity of the powder equivalent to about 0.1 g (100 000 IU) of erythromycin, accurately weighed, add sufficient methanol R to produce 100 ml, shake, and allow the sediment to settle. Carefully transfer 40 ml of the clear solution to a 100-ml volumetric flask, dilute to

volume with sterile phosphate buffer, pH 8.0, TS1 or TS2, and allow to stand, protected from light, for 5 hours at 20–25 °C. Carry out the assay as described under “Microbiological assay of antibiotics” (Vol. 1, p. 145), using *Bacillus pumilus* (NCTC 8241 or ATCC 14884) as the test organism, culture medium Cm1 with a final pH of 8.0–8.1, sterile phosphate buffer, pH 8.0, TS1 or TS2, an appropriate concentration of Erythromycin (usually between 5 and 15 IU per ml), and an incubation temperature of 35–39 °C. The precision of the assay is such that the fiducial limits of error of the estimated potency ($P = 0.95$) are not less than 95% and not more than 105%. The upper fiducial limit of error is not less than 95.0% and the lower fiducial limit of error is not more than 110.0% of the content stated on the label, expressed in mg, with 1000 IU being equivalent to 1 mg of erythromycin.

Dissolution test. (See Preface, p. vii.)

Erythromycini stearatis compressi

Erythromycin stearate tablets

Category. Antibacterial.

Storage. Erythromycin stearate tablets should be kept in a tightly closed container.

Additional information. Strength in the current WHO Model list of essential drugs: 250 mg of erythromycin.

Requirements

Complies with the monograph for “Tablets” (see Vol. 4, p. 26).

Identity tests

- *Either tests A and D or tests B, C, and D may be applied.*

A. To a quantity of the powdered tablets equivalent to about 0.2 g of Erythromycin stearate add 20 ml of water and shake. Decant the supernatant liquid and discard. Add 10 ml of methanol R to the residue, shake, filter, and evaporate to dryness. Carry out the examination with the dried residue as described under “Spectrophotometry in the infrared region” (Vol. 1, p. 40). The infrared absorption spectrum is concordant with the spectrum obtained from erythromycin stearate RS or with the *reference spectrum* of erythromycin stearate.

- B. Carry out the test as described under “Thin-layer chromatography” (Vol. 1, p. 83), using silica gel R4 as the coating substance and a mixture of 85 volumes of methanol R and 15 volumes of chloroform R as the mobile phase. Apply separately to the plate 20 µl of each of the following 2 solutions. For solution (A) shake a quantity of the powdered tablets equivalent to about 0.05 g of Erythromycin stearate with 10 ml of methanol R by mechanical means for 30 minutes. Centrifuge a portion of this mixture and use the clear supernatant liquid. For solution (B) use 5 mg of erythromycin stearate RS per ml of methanol R. After removing the plate from the chromatographic chamber, allow it to dry in a current of air, and spray with dichlorofluorescein TS. Heat the plate at 100 °C for 10 minutes and examine the chromatogram in ultraviolet light (365 nm).

The principal spot obtained with solution A corresponds in position, appearance, and intensity with that obtained with solution B.

Next, spray the plate with a mixture of 90 volumes of dehydrated ethanol R, 5 volumes of anisaldehyde R, and 5 volumes of sulfuric acid (~1760 g/l) TS. Heat the plate at 100 °C for 10 minutes and examine the chromatogram in daylight.

The principal spot obtained with solution A corresponds in position, appearance, and intensity with that obtained with solution B.

- C. To a quantity of the powdered tablets equivalent to about 10 mg of Erythromycin stearate add 2.0 ml of acetone R and about 2 ml of hydrochloric acid (~420 g/l) TS and shake; a pale orange colour is produced, which changes to red or violet-red. Add 2.0 ml of chloroform R and shake; the chloroform layer acquires a violet colour.
- D. Shake a quantity of the powdered tablets equivalent to about 0.1 g of Erythromycin stearate with 10 ml of chloroform R, filter, and evaporate the filtrate to dryness on a water-bath. Gently heat the residue with 10 ml of water and 5 ml of hydrochloric acid (~70 g/l) TS until the solution boils; oily globules rise to the surface. Cool, remove the fatty layer, and heat it with 3.0 ml of sodium hydroxide (0.1 mol/l) VS. Allow to cool; the solution sets to a gel. Add 10 ml of hot water, shake, heat the mixture for 2–3 minutes and shake again; the solution froths. To 1.0 ml of the resulting solution add 2.0 ml of calcium chloride (55 g/l) TS; a granular precipitate is produced, which is insoluble in hydrochloric acid (~250 g/l) TS.

Assay. Weigh and powder 20 tablets. To a quantity of the powder equivalent to about 0.1 g (100 000 IU) of erythromycin, accurately weighed, add sufficient methanol R to produce 100 ml, shake, and allow the sediment to settle. Carefully transfer 40 ml of the clear solution to a 100-ml volumetric flask, dilute to volume with sterile phosphate buffer, pH 8.0, TS1 or TS2, and allow to stand,

protected from light, for 5 hours at 20–25 °C. Carry out the assay as described under “Microbiological assay of antibiotics” (Vol. 1, p. 145), using *Bacillus pumilus* (NCTC 8241 or ATCC 14884) as the test organism, culture medium Cm1 with a final pH of 8.0–8.1, sterile phosphate buffer, pH 8.0, TS1 or TS2, an appropriate concentration of Erythromycin (usually between 5 and 15 IU per ml), and an incubation temperature of 35–39 °C. The precision of the assay is such that the fiducial limits of error of the estimated potency ($P = 0.95$) are not less than 95% and not more than 105%. The upper fiducial limit of error is not less than 95.0% and the lower fiducial limit of error is not more than 110.0% of the content stated on the label, expressed in mg, with 1000 IU being equivalent to 1 mg of erythromycin.

Dissolution test. (See Preface, p. vii.)

Ethambutoli hydrochloridi compressi

Ethambutol hydrochloride tablets

Category. Antituberculosis drug.

Additional information. Strength in the current WHO Model list of essential drugs: 100–400 mg.

Requirements

Complies with the monograph for “Tablets” (see Vol. 4, p. 26).

Ethambutol hydrochloride tablets contain not less than **90.0%** and not more than **110.0%** of the amount of $C_{10}H_{24}N_2O_2, 2HCl$ stated on the label.

Identity tests

- *Either tests A and C or tests B and C may be applied.*

To a quantity of the powdered tablets equivalent to about 0.1 g of Ethambutol hydrochloride add 10 ml of methanol R and shake. Filter the extract and evaporate to dryness. Use the residue for tests A and C.

A. Carry out the examination with the residue as described under “Spectrophotometry in the infrared region” (Vol. 1, p. 40). The infrared absorption spectrum is concordant with the spectrum obtained from ethambutol hydrochloride RS or with the *reference spectrum* of ethambutol hydrochloride.

- B. Carry out the test as described under “Thin-layer chromatography (Vol. 1, p. 83), using silica gel R1 as the coating substance and a mixture of 100 volumes of methanol R and 1.5 volumes of ammonia (~260 g/l) TS as the mobile phase. Apply separately to the plate 10 µl of each of the following 2 solutions. For solution (A) shake a quantity of the powdered tablets equivalent to about 10 mg of Ethambutol hydrochloride with 10 ml of water, filter, and use the filtrate. For solution (B) use 1.0 mg of ethambutol hydrochloride RS per ml. After removing the plate from the chromatographic chamber, allow it to dry in air, and expose it to the vapour of iodine R until spots appear. Examine the chromatogram in daylight.

The principal spot obtained with solution A corresponds in position, appearance, and intensity with that obtained with solution B.

- C. The residue yields reaction A described under “General identification tests” as characteristic of chlorides (Vol. 1, p. 112).

Aminobutanol. Carry out the test as described under “Thin-layer chromatography” (Vol. 1, p. 83), using silica gel R1 as the coating substance and a mixture of 55 volumes of ethyl acetate R, 35 volumes of glacial acetic acid R, 5 volumes of hydrochloric acid (~420 g/l) TS, and 1 volume of water as the mobile phase. Apply separately to the plate 2 µl of each of the following 2 solutions. For solution (A) shake a quantity of the powdered tablets equivalent to about 0.5 g of Ethambutol hydrochloride with 10 ml of methanol R for 5 minutes, filter, and use the filtrate. For solution (B) use 0.5 mg of aminobutanol R per ml of methanol R. After removing the plate from the chromatographic chamber, allow it to dry in air, heat at 105 °C for 5 minutes, cool, spray with triketohydrindene/cadmium TS, and heat again at 90 °C for 5 minutes. Examine the chromatogram in daylight.

Any spot corresponding to aminobutanol obtained with solution A is not more intense than that obtained with solution B.

Assay. Weigh and powder 20 tablets. To a quantity of the powder equivalent to about 0.2 g of Ethambutol hydrochloride add 10 ml of sodium hydroxide (~80 g/l) TS and extract with 5 portions, each of 20 ml, of chloroform R. Evaporate the combined extracts to a volume of about 25 ml, filter, and add 100 ml of glacial acetic acid R1. Add 1-naphtholbenzein/acetic acid TS and titrate with perchloric acid (0.1 mol/l) VS as described under “Non-aqueous titration”, Method A (Vol. 1, p. 131).

Each ml of perchloric acid (0.1 mol/l) VS is equivalent to 13.86 mg of $C_{10}H_{24}N_2O_2$, 2HCl.

Dissolution test. (See Preface, p. vii.)

Ibuprofeni compressi

Ibuprofen tablets

Category. Non-steroidal anti-inflammatory drug.

Additional information. Strength in the current WHO Model list of essential drugs: 200 mg, 400 mg.

Requirements

Complies with the monograph for "Tablets" (see Vol. 4, p. 26).

Ibuprofen tablets contain not less than **90.0%** and not more than **110.0%** of the amount of $C_{13}H_{18}O_2$ stated on the label.

Identity tests

- *Either tests A and C or tests B and C may be applied.*

To a quantity of the powdered tablets equivalent to about 0.8 g of Ibuprofen add 20 ml of acetone R, filter, and allow the filtrate to evaporate without heating. To the residue add 10 ml of acetone R, allow to crystallize, separate the crystals, dry in air, and use the dried crystals for the following tests.

- A. Carry out the examination with the dried crystals as described under "Spectrophotometry in the infrared region" (Vol. 1, p. 40). The infrared absorption spectrum is concordant with the spectrum obtained from ibuprofen RS or with the *reference spectrum* of ibuprofen.
- B. Dissolve 25 mg of the dried crystals in sufficient sodium hydroxide (0.1 mol/l) VS to produce 100 ml. The absorption spectrum of the resulting solution, when observed between 230 nm and 350 nm, exhibits maxima at about 265 nm and 273 nm, minima at about 245 nm and 271 nm, and a shoulder at about 259 nm.
- C. Melting temperature of the dried crystals, about 76 °C.

Related substances. Carry out the test as described under "Thin-layer chromatography" (Vol. 1, p. 83), using silica gel R3 as the coating substance and a mixture of 15 volumes of hexane R, 5 volumes of ethyl acetate R, and 1 volume of glacial acetic acid R as the mobile phase. Apply separately to the plate 5 μ l of each of the following 3 solutions. For solution (A) shake a quantity of the powdered tablets equivalent to about 0.2 g of Ibuprofen with three 10-ml quantities of chloroform R, filter, evaporate the combined filtrates to a volume of about 1 ml, and add sufficient chloroform R to produce 2 ml. For solution (B)

dilute 1 volume of solution A to 100 volumes with chloroform R. After removing the plate from the chromatographic chamber, allow it to dry in air, and spray very lightly with a solution of 10 mg of potassium permanganate R per ml of sulfuric acid (~100 g/l) TS. Heat again at 120°C for 20 minutes and examine the chromatogram in ultraviolet light (365 nm).

Any spot obtained with solution A, other than the principal spot, is not more intense than that obtained with solution B.

Assay. Weigh and powder 20 tablets. To a quantity of the powder equivalent to about 0.5 g of Ibuprofen add 60 ml of chloroform R and shake for 15 minutes. Filter through a fine glass microfibre paper (e.g. Whatman GF/F) under reduced pressure. Wash the residue with 2 quantities, each of 20 ml of chloroform R, and evaporate the combined filtrates in a current of air until just dry. Dissolve the residue in 100 ml of neutralized ethanol TS and titrate with sodium hydroxide (0.1 mol/l) VS, determining the end-point potentiometrically.

Each ml of sodium hydroxide (0.1 mol/l) VS is equivalent to 20.63 mg of $C_{13}H_{18}O_2$.

Dissolution test. (See Preface, p. vii.)

Indometacini compressi

Indometacin tablets

Category. Non-steroidal anti-inflammatory drug.

Requirements

Complies with the monograph for "Tablets" (see Vol. 4, p. 26).

Indometacin tablets contain not less than **90.0%** and not more than **110.0%** of the amount of $C_{19}H_{16}ClNO_4$ stated on the label.

Identity tests

- *Either test A alone or tests B and C may be applied.*

A. To a quantity of the powdered tablets equivalent to about 0.1 g of Indometacin add 5 ml of chloroform R and shake. Filter and evaporate the filtrate to dryness. Dry the residue at 70°C under reduced pressure (not exceeding 0.6 kPa or 5 mm of mercury). Carry out the examination with the residue as described under "Spectrophotometry in the infrared region"

(Vol. 1, p. 40). The infrared absorption spectrum is concordant with the spectrum obtained from indometacin RS or with the *reference spectrum* of indometacin.

- B. To a quantity of the powdered tablets equivalent to about 0.05 g of Indometacin add 60 ml of ethanol (~750 g/l) TS and shake. Allow to stand for 10 minutes, shake again, and dilute with sufficient ethanol (~750 g/l) TS to produce 100 ml. Filter, discard the first 10 ml of filtrate, then dilute 5 ml of the filtrate to 100 ml with the same solvent. The absorption spectrum of the resulting solution, when observed between 300 nm and 350 nm, exhibits a maximum at about 318 nm.
- C. To a quantity of the powdered tablets equivalent to about 25 mg add 10 ml of water, 2 drops of sodium hydroxide (~200 g/l) TS, shake, and filter. To the filtrate add 1.0 ml of sodium nitrite (10 g/l) TS, allow to stand for 5 minutes, and carefully add about 0.5 ml of hydrochloric acid (~250 g/l) TS; a green colour is produced.

Related substances. Carry out the test as described under “Thin-layer chromatography” (Vol. 1, p. 83), using silica gel R2 as the coating substance and preparing a slurry in sodium dihydrogen phosphate (45 g/l) TS. As the mobile phase, use a mixture of 7 volumes of ether R and 3 volumes of light petroleum R1. Apply separately to the plate 5 μ l of each of the following 2 solutions. For solution (A) shake a quantity of the powdered tablets equivalent to about 0.1 g of Indometacin with 5 ml of chloroform R, filter, and use the filtrate. For solution (B) dilute 1 volume of solution A to 20 volumes with chloroform R, further dilute 1 volume of this solution to 10 volumes with the same solvent. After removing the plate from the chromatographic chamber, allow it to dry in air, and examine the chromatogram in ultraviolet light (254 nm).

Any spot obtained with solution A, other than the principal spot, is not more intense than that obtained with solution B.

Assay. Weigh and powder 20 tablets. To a quantity of the powder equivalent of about 0.05 g of Indometacin add 10 ml of water and allow to stand for 15 minutes, swirling occasionally. Add 75 ml of methanol R, shake well, add sufficient methanol R to produce 100 ml, and filter. To 5 ml of the filtrate add a mixture of equal volumes of methanol R and phosphate buffer pH 7.2, TS to produce 100 ml. Measure the absorbance of a 1-cm layer at the maximum at about 318 nm against a solvent cell containing the above solvent mixture.

Calculate the percentage content of $C_{19}H_{16}ClNO_4$ using the absorptivity value of 19.3 ($A_{1\text{cm}}^{1\%} = 193$).

Dissolution test. (See Preface, p. vii.)

Isoniazidi compressi

Isoniazid tablets

Category. Antituberculosis drug.

Additional information. Strength in the current WHO Model list of essential drugs: 100–300 mg.

Requirements

Complies with the monograph for "Tablets" (see Vol. 4, p. 26).

Isoniazid tablets contain not less than **90.0%** and not more than **110.0%** of the amount of $C_6H_7N_3O$ stated on the label.

Identity tests

- *Either test A alone or tests B and C may be applied.*
- A. To a quantity of the powdered tablets equivalent to about 0.1 g of Isoniazid add 10 ml of ethanol (~750 g/l) TS and shake for 15 minutes. Centrifuge and decant the supernatant liquid. Extract the remaining liquid with two further 10-ml quantities of ethanol (~750 g/l) TS and evaporate the combined extracts to dryness. Carry out the examination with the residue as described under "Spectrophotometry in the infrared region" (Vol. 1, p. 40). The infrared absorption spectrum is concordant with the spectrum obtained from isoniazid RS or with the *reference spectrum* of isoniazid.
- B. To a quantity of the powdered tablets equivalent to about 0.1 g of Isoniazid add 2.0 ml of water, shake, and filter. Then add a mixture composed of 1.0 ml of silver nitrate (40 g/l) TS and 1.0 ml of ammonia (~100 g/l) TS; bubbles of nitrogen evolve, the mixture turns from yellow to black and a metallic silver mirror appears on the sides of the test-tube.
- C. To a quantity of the powdered tablets equivalent to about 1 mg of Isoniazid add 50 ml of ethanol (~750 g/l) TS, shake, and filter. To 5 ml of the filtrate add 0.1 g of sodium tetraborate R and 5 ml of 1-chloro-2,4 dinitrobenzene/ethanol TS, evaporate to dryness on a water-bath, and continue heating for a further 10 minutes. To the residue add 10 ml of methanol R and mix; a reddish violet colour is produced.

Related substances. Carry out the test as described under "Thin-layer chromatography" (Vol. 1, p. 83), using silica gel R2 as the coating substance and a mixture of 5 volumes of ethyl acetate R, 2 volumes of acetone R, 2 volumes of methanol R, and 1 volume of water as the mobile phase. Apply separately to

the plate 10 µl of each of the 3 following solutions. For solution (A) shake a quantity of the powdered tablets equivalent to about 0.1 g of Isoniazid with 10 ml of methanol R, filter, and use the filtrate. For solution (B) use 10 mg of isoniazid RS per ml of methanol R. For solution (C) dilute 1 volume of solution A to 100 volumes with methanol R. After removing the plate from the chromatographic chamber, allow it to dry in air, and examine the chromatogram in ultraviolet light (254 nm).

Any spot obtained with solution A, other than the principal spot, is not more intense than that obtained with solution C.

Assay. Weigh and powder 20 tablets. Dissolve a quantity of the powdered tablets equivalent to about 0.4 g of Isoniazid as completely as possible in water, filter, and wash the residue with sufficient water to produce 250 ml. Place 50 ml of the resulting solution in a titration vessel, add 50 ml of water, 20 ml of hydrochloric acid (~250 g/l) TS, and 0.2 g of potassium bromide R, and titrate with potassium bromate (0.0167 mol/l) VS as described under "Nitrite titration" (Vol. 1, p. 133).

Each ml of potassium bromate (0.0167 mol/l) VS is equivalent to 3.429 mg of $C_6H_7N_3O$.

Dissolution test. (See Preface, p. vii.)

Morphini sulfatis compressi

Morphine sulfate tablets

Category. Opioid analgesic.

Additional information. Strength in the current WHO Model list of essential drugs: 10 mg.

Requirements

Complies with the monograph for "Tablets" (see Vol. 4, p. 26).

Morphine sulfate tablets contain not less than **90.0%** and not more than **110.0%** of the amount of $(C_{17}H_{19}NO_3)_2 \cdot H_2SO_4 \cdot 5H_2O$ stated on the label.

Identity tests

- *Either tests A and D or tests B, C, and D may be applied.*

- A. To a quantity of the powdered tablets equivalent to about 0.1 g of Morphine sulfate add 10 ml of ethanol (~750 g/l) TS and shake for 15 minutes. Centrifuge and decant the supernatant liquid. Extract the remaining liquid with two further 10-ml quantities of ethanol (~750 g/l) TS and evaporate the combined extracts to dryness. Carry out the examination with the residue as described under "Spectrophotometry in the infrared region" (Vol. 1, p. 40). The infrared absorption spectrum is concordant with the *reference spectrum* of morphine sulfate.
- B. To a quantity of the powdered tablets equivalent to about 20 mg of Morphine sulfate add 5 ml of water, shake, and filter. To the filtrate add 0.05 ml of ferric chloride (25 g/l) TS; a blue colour is produced.
- C. To a quantity of the powdered tablets equivalent to about 20 mg of Morphine sulfate add 5 ml of sulfuric acid (0.05 mol/l) VS, shake, and filter. To the filtrate add 0.5 ml of a saturated solution of potassium iodate R; an amber colour is produced which reaches maximum intensity after 5 minutes. Add 0.5 ml of ammonia (~260 g/l) TS; the colour darkens almost to black.
- D. To a quantity of the powdered tablets equivalent to about 20 mg of Morphine sulfate add 5 ml of water, shake, and filter. The filtrate yields the reactions described under "General identification tests" as characteristic of sulfates (Vol. 1, p. 115).

Assay. Weigh and powder 20 tablets. To a quantity of the powdered tablets equivalent to about 0.4 g of Morphine sulfate add 25 ml of water, 5 ml of sodium hydroxide (1 mol/l) VS, and 1 g of ammonium sulfate R, swirl to dissolve. Add 20 ml of ethanol (~750 g/l) TS and extract with successive quantities of 40 ml, 20 ml, 20 ml, and 20 ml of a mixture of 3 volumes of chloroform R and 1 volume of ethanol (~750 g/l) TS. Wash each extract with the same 5 ml of water, filter, and evaporate the solvent. Dissolve the residue in 10 ml of hydrochloric acid (0.05 mol/l) VS, boil, cool, add 15 ml of water and a few drops of methyl red/ethanol TS. Titrate the excess acid with sodium hydroxide (0.05 mol/l) VS.

Each ml of hydrochloric acid (0.05 mol/l) VS is equivalent to 18.97 mg of $(C_{17}H_{19}NO_3)_2 \cdot H_2SO_4 \cdot 5H_2O$.

Pethidini hydrochloridi compressi

Pethidine hydrochloride tablets

Category. Opioid analgesic.

Additional information. Strength in the current WHO Model list of essential drugs: 50 mg, 100 mg.

Requirements

Complies with the monograph for "Tablets" (see Vol. 4, p. 26).

Pethidine hydrochloride tablets contain not less than **90.0%** and not more than **110.0%** of the amount of $C_{15}H_{21}NO_2 \cdot HCl$ stated on the label.

Identity tests

- *Either tests A and D or tests B, C, and D may be applied.*

A. To a quantity of the powdered tablets equivalent to about 0.05 g of Pethidine hydrochloride add 20 ml of chloroform R, shake, and filter. Evaporate the filtrate to dryness and dry the residue under reduced pressure (not exceeding 0.6 kPa or 5 mm of mercury). Carry out the examination with the residue as described under "Spectrophotometry in the infrared region" (Vol. 1, p. 40). The infrared absorption spectrum is concordant with the *reference spectrum* of pethidine hydrochloride.

B. To a quantity of the powdered tablets equivalent to about 0.2 g of Pethidine hydrochloride add 20 ml of water, shake, and filter. To 5 ml of the filtrate (keep the remaining filtrate for tests C and D) add 5 ml of trinitrophenol/ethanol TS and shake; a yellow, crystalline precipitate is produced. Filter, wash with water, and dry the crystals at 105 °C for 2 hours; melting temperature, about 190 °C.

C. Evaporate 1 ml of the filtrate from test B to dryness on a water-bath, dissolve the residue in 1 ml of formaldehyde/sulfuric acid TS, and heat gently; the colour of the solution turns to pink, changing to violet-red and showing a red fluorescence when held in front of a strong light.

D. Dilute 5 ml of the filtrate from test B with 5 ml of water; it yields the reactions described under "General identification tests" as characteristic of chlorides (Vol. 1, p. 112).

Related substances. Carry out the test as described under "Thin-layer chromatography (Vol. 1, p. 83), using kieselguhr R1 as the coating substance and a mixture of 9 volumes of acetone R and 1 volume of 2-phenoxyethanol R to impregnate the plate, dipping it about 5 mm into the liquid. After the solvent has reached a height of at least 16 cm, remove the plate from the chromatographic chamber, and dry it in a current of air. Use the impregnated plate immediately, carrying out the chromatography in the same direction as the impregnation.

Shake together 100 volumes of light petroleum R1, 8 volumes of 2-phenoxyethanol R, and 1 volume of diethylamine R, allow to settle, and use this solution as the mobile phase. Apply separately to the plate 5 µl of each of the following 2 solutions. For solution (A) shake a quantity of the powdered tablets equivalent to about 0.1 g of Pethidine hydrochloride with 5 ml of water, filter, shake the filtrate with 0.5 ml of sodium hydroxide (~200 g/l) TS and 2 ml of ether R, allow the layers to separate, and use the upper layer. For solution (B) dilute 0.5 ml of solution A to 50 ml with ether R. After removing the plate from the chromatographic chamber, allow it to dry in air for 10 minutes, return it to the chromatographic chamber, and repeat the development. Remove the plate, allow it to dry in air for 10 minutes, and spray with dichlorofluorescein TS. Allow to stand for 5 minutes and spray with water until the background is white to pale yellow.

Examine the chromatogram in daylight. The chromatogram shows red to orange spots.

Any spot obtained with solution A, other than the principal spot, is not more intense than that obtained with solution B.

Examine the chromatogram without delay in ultraviolet light (365 nm). The chromatogram shows spots with intense yellow fluorescence.

Any spot obtained with solution A, other than the principal spot, is not more intense than that obtained with solution B.

Assay. Weigh and powder 20 tablets. To a quantity of the powdered tablets equivalent to about 0.5 g of Pethidine hydrochloride add 40 ml of water, 2.0 ml of sodium hydroxide (~200 g/l) TS, and extract immediately with quantities of 25 ml, 10 ml, and 10 ml of chloroform R. Wash each extract with the same 15 ml of water and filter into a dry flask. To the combined extracts, which should be clear and free from droplets of water, add 0.15 ml of 1-naphtholbenzein/acetic acid TS and titrate with perchloric acid (0.05 mol/l) VS as described under "Non-aqueous titration", Method A (Vol. 1, p. 131).

Each ml of perchloric acid (0.05 mol/l) VS is equivalent to 14.19 mg of $C_{15}H_{21}NO_2 \cdot HCl$.

Phenobarbitali compressi

Phenobarbital tablets

Category. Antiepileptic drug.

Additional information. Strength in the current WHO Model list of essential drugs: 15–100 mg.

Requirements

Complies with the monograph for "Tablets" (see Vol. 4, p. 26).

Phenobarbital tablets contain not less than **90.0%** and not more than **110.0%** of the amount of $C_{12}H_{12}N_2O_3$ stated on the label.

Identity tests

- *Either tests A, C, and D or tests B, C, and D may be applied.*

To a quantity of the powdered tablets equivalent to about 0.4 g of Phenobarbital add 10 ml of dehydrated ethanol R, shake, and filter. Evaporate the filtrate to dryness and dry the residue at 105 °C for 1 hour. Use the residue for the following tests.

- A. Carry out the examination with the residue as described under "Spectrophotometry in the infrared region" (Vol. 1, p. 40). The infrared absorption spectrum is concordant with the spectrum obtained from phenobarbital RS or with the *reference spectrum* of phenobarbital. If the spectra obtained are not concordant, heat the residue in a sealed tube at 105 °C for 1 hour and prepare a new spectrum of the residue.
- B. Melting temperature of the residue, about 174 °C.
- C. Dissolve 20 mg of the residue in 5 ml of methanol R, add 1 drop of cobalt(II) chloride (30 g/l) TS and 3–4 drops of ammonia (~100 g/l) TS; a violet colour is produced.
- D. To 0.20 g of the residue add about 2 ml of sulfuric acid (~1760 g/l) TS, 20 mg of sodium nitrate R, and allow to stand for 30 minutes; a yellow colour is produced.

Assay. Weigh and powder 20 tablets. To a quantity of the powdered tablets equivalent to about 0.2 g of Phenobarbital add 40 ml of methanol R and 15 ml of a freshly prepared solution of 30 mg of anhydrous sodium carbonate R per ml. Titrate with silver nitrate (0.1 mol/l) VS, determining the end-point potentiometrically.

Each ml of silver nitrate (0.1 mol/l) VS is equivalent to 23.22 mg of $C_{12}H_{12}N_2O_3$.

Disintegration test. Complies with the "Disintegration test for tablets and capsules" (Vol. 4, p. 40). Time period: 30 minutes.

Phenytoini natrici compressi

Phenytoin sodium tablets

Category. Antiepileptic drug.

Additional information. Strength in the current WHO Model list of essential drugs: 25 mg, 50 mg, 100 mg.

Requirements

Complies with the monograph for "Tablets" (see Vol. 4, P. 26).

Phenytoin sodium tablets contain not less than **90.0%** and not more than **110.0%** of the amount of $C_{15}H_{11}N_2NaO_2$ stated on the label.

Identity tests

- *Either tests A and D or tests B, C, and D may be applied.*

To a quantity of the powdered tablets equivalent to about 0.1 g of Phenytoin sodium add 20 ml of water, shake, and filter. Acidify the filtrate with hydrochloric acid (~70 g/l) TS and extract with chloroform R. Wash the chloroform extract with water, dry with anhydrous sodium sulfate R, and evaporate to dryness. Use the residue for tests A and B.

A. Carry out the examination with the residue as described under "Spectrophotometry in the infrared region" (Vol. 1, p. 40). The infrared absorption spectrum is concordant with the spectrum obtained from phenytoin RS or with the *reference spectrum* of phenytoin.

B. Carry out the test as described under "Thin-layer chromatography (Vol. 1, p. 83), using silica gel R4 as the coating substance and a mixture of 9 volumes of chloroform R and 1 volume of acetone R as the mobile phase. Apply separately to the plate 10 μ l of each of the following 2 solutions in chloroform R. For solution (A) use 1 mg of the residue per ml. For solution (B) use 1 mg of phenytoin RS per ml. After removing the plate from the chromatographic chamber, allow it to dry, and examine the chromatogram in ultraviolet light (254 nm).

The principal spot obtained with solution A corresponds in position, appearance, and intensity with that obtained with solution B.

C. To a quantity of the powdered tablets equivalent to about 40 mg of Phenytoin sodium add 2.0 ml of ammonia (~100 g/l) TS and heat until boiling begins. Add 1 drop of copper(II) sulfate (160 g/l) TS and shake; a

blue-violet solution with a blue-green precipitate is produced. Allow to stand for 3 minutes, filter, and wash with water; pink needles remain on the filter.

- D. To a quantity of the powdered tablets equivalent to about 40 mg of Phenytoin sodium add 5 ml of water, shake, and filter. The filtrate yields reaction B described under "General identification tests" as characteristic of sodium (Vol. 1, p. 115).

Benzophenone. Carry out the test as described under "Thin-layer chromatography" (Vol. 1, p. 83), using silica gel R4 as the coating substance and a mixture of 75 volumes of hexane R and 30 volumes of dioxan R as the mobile phase. Apply separately to the plate 5 μ l of each of the following 2 solutions. For solution (A) shake a quantity of the powdered tablets equivalent to about 0.1 g of Phenytoin sodium with 5 ml of methanol R, warm on a water-bath while shaking, filter, and use the filtrate. For solution (B) use 0.10 mg of benzophenone R per ml of methanol R. After removing the plate from the chromatographic chamber, allow it to dry in air, and examine the chromatogram in ultraviolet light (254 nm).

Any spot corresponding to benzophenone obtained with solution A is not more intense than that obtained with solution B.

Assay. Weigh and powder 20 tablets. Transfer to a separatory funnel a quantity of the powdered tablets equivalent to about 0.3 g of Phenytoin sodium, add 25 ml of water, and shake. Add 50 ml of ether R, shake, and add 10 drops of bromophenol blue/ethanol TS. Titrate with hydrochloric acid (0.1 mol/l) VS, shaking vigorously, until the colour of the aqueous layer turns to bluish-grey. Transfer the aqueous layer to a stoppered conical flask. Wash the ether layer with 5 ml of water and combine the washing with the aqueous layer in the conical flask. Add 20 ml of ether R and continue the titration with hydrochloric acid (0.1 mol/l) VS, shaking vigorously, until the colour of the aqueous layer turns to pale green.

Each ml of hydrochloric acid (0.1 mol/l) VS is equivalent to 27.43 mg of $C_{15}H_{11}N_2NaO_2$.

Dissolution test. (See Preface, p. vii.)

Praziquanteli compressi

Praziquantel tablets

Category. Anthelmintic drug.

Additional information. Strength in the current WHO Model list of essential drugs: 150 mg, 600 mg.

Requirements

Complies with the monograph for "Tablets" (see Vol. 4, p. 26).

Praziquantel tablets contain not less than **90.0%** and not more than **110.0%** of the amount of $C_{19}H_{24}N_2O_2$ stated on the label.

Identity tests

- *Either test A alone or tests B, C, and D may be applied.*

To a quantity of the powdered tablets equivalent to about 0.1 g of Praziquantel add 10 ml of chloroform R, shake, and filter. Evaporate the filtrate to dryness and dry the residue at 50 °C under reduced pressure (not exceeding 0.6 kPa or about 5 mm of mercury). Use the residue for tests A and D.

- Carry out the examination with the residue as described under "Spectrophotometry in the infrared region" (Vol. 1, p. 40). The infrared absorption spectrum is concordant with the spectrum obtained from praziquantel RS or with the *reference spectrum* of praziquantel.
- See the test described below under "Related substances". The principal spot obtained with solution A corresponds in position, appearance, and intensity with that obtained with solution B.
- The absorption spectrum of the solution obtained in the "Assay", when observed between 230 nm and 350 nm, exhibits two maxima at about 264 nm and 272 nm.
- Melting temperature of the residue, about 138 °C.

Related substances. Carry out the test as described under "Thin-layer chromatography" (Vol. 1, p. 83), using silica gel R5 as the coating substance and a mixture of 85 volumes of toluene R and 15 volumes of methanol R as the mobile phase. Apply separately to the plate, in a current of nitrogen R, 10 µl of each of the following 2 solutions. For solution (A) shake a quantity of the powdered tablets equivalent to about 0.25 g of Praziquantel with 5 ml of chloroform R, filter, and use the filtrate. For solution (B) use 0.05 g of praziquantel RS per ml of chloroform R. Then apply 2 µl of each of the following 2 solutions in chloroform R containing (C) 0.5 mg of praziquantel RS per ml, and (D) 1.0 mg of praziquantel RS per ml. Allow the mobile phase to ascend 7 cm. After removing the plate from the chromatographic chamber, allow it to dry in a current of warm air, place in a chamber with iodine vapours, and allow to stand for 20 minutes. Examine the chromatogram immediately in daylight.

Any spot obtained with solution A, other than the principal spot, is not more intense than that obtained with solution C, except one spot above the main spot which is not more intense than that obtained with solution D.

Assay. Weigh and powder 20 tablets. To a quantity of the powder equivalent to about 25 mg of Praziquantel add 50 ml of ethanol (~750 g/l) TS, shake, and dilute to volume with the same solvent. Filter and discard the first 5 ml of the filtrate. Measure the absorbance of a 1-cm layer at the maximum at about 264 nm against a solvent cell containing ethanol (~750 g/l) TS. Calculate the percentage content of $C_{19}H_{24}N_2O_2$ by comparison with a solution containing 0.50 mg of praziquantel RS per ml of ethanol (~750 g/l) TS.

Prednisoloni compressi

Prednisolone tablets

Category. Adrenal hormone.

Additional information. Strength in the current WHO Model list of essential drugs: 1 mg, 5 mg.

Requirements

Complies with the monograph for "Tablets" (see Vol. 4, p. 26).

Prednisolone tablets contain not less than **90.0%** and not more than **110.0%** of the amount of $C_{21}H_{28}O_5$ stated on the label.

Identity tests

- *Either test A alone or tests B and C may be applied.*

To a quantity of the powdered tablets equivalent to about 0.05 g of Prednisolone add 10 ml of acetone R, shake, and filter. Evaporate the filtrate to dryness and use the residue for the "Identity tests" and "Related substances".

- A. Carry out the examination with the residue as described under "Spectrophotometry in the infrared region" (Vol. 1, p. 40). The infrared absorption spectrum is concordant with the spectrum obtained from prednisolone RS or with the *reference spectrum* of prednisolone.
- B. Carry out the test as described under "Thin-layer chromatography" (Vol. 1, p. 83), using kieselguhr R1 as the coating substance and a mixture of 9 volumes of acetone R and 1 volume of formamide R to impregnate the plate, dipping it about 5 mm into the liquid. After the solvent has reached a height

of at least 16 cm, remove the plate from the chromatographic chamber and allow it to stand at room temperature until the solvent has completely evaporated. Use the impregnated plate within 2 hours, carrying out the chromatography in the same direction as the impregnation. Use chloroform R as the mobile phase. Apply separately to the plate 2 µl of each of 2 solutions in a mixture of 9 volumes of chloroform R and 1 volume of methanol R containing (A) 2.5 mg of the residue per ml, and (B) 2.5 mg of prednisolone RS per ml. Develop the plate for a distance of 15 cm. After removing the plate from the chromatographic chamber, allow it to dry in air until the solvents have evaporated, heat at 120 °C for 15 minutes, and spray the hot plate with sulfuric acid/ethanol TS. Heat at 120 °C for a further 10 minutes, allow to cool, and examine the chromatogram in daylight and in ultraviolet light (365 nm).

The principal spot obtained with solution A corresponds in position, appearance, and intensity with that obtained with solution B.

C. To 5 mg of the residue add 1.0 ml of ethanol (~750 g/l) TS and shake. Then add 1.0 ml of potassio-cupric tartrate TS and heat to boiling; an orange precipitate is produced slowly.

Related substances. Carry out the test as described under “Thin-layer chromatography” (Vol. 1, p. 83), using silica gel R2 as the coating substance and a mixture of 77 volumes of dichloromethane R, 15 volumes of ether R, 8 volumes of methanol R, and 1.2 volumes of water as the mobile phase. Apply separately to the plate 1 µl of each of 2 solutions in a mixture of 9 volumes of chloroform R and 1 volume of methanol R containing (A) 15 mg of the residue per ml, and (B) 0.30 mg of the residue per ml. After removing the plate from the chromatographic chamber, allow it to dry in air until the solvents have evaporated, and heat at 105 °C for 10 minutes. Cool, and examine the chromatogram in ultraviolet light (254 nm).

Any spot obtained with solution A, other than the principal spot, is not more intense than that obtained with solution B.

Assay. Weigh and powder 20 tablets. To a quantity of the powdered tablets equivalent to about 20 mg of Prednisolone, add 15 ml of water, shake with four quantities, each of 25 ml, of chloroform R, and filter the chloroform layer through cotton wool previously washed with chloroform R. Add sufficient chloroform R to the filtrate to produce 250 ml and dilute 25 ml to 100 ml with the same solvent. Transfer 10 ml of the resulting solution to a glass-stoppered, 50-ml conical flask, carefully evaporate to dryness, and dissolve the residue in 20 ml of dehydrated ethanol R. Transfer 20 ml of dehydrated ethanol R to a similar flask to serve as the blank. To each of the flasks add 2.0 ml of blue tetrazolium/ethanol TS and mix. Then add to each flask 2.0 ml of tetramethylammonium hydroxide/ethanol TS, mix, and allow to stand in the dark for

90 minutes. Measure the absorbance of a 1-cm layer at the maximum at about 525 nm against a solvent cell containing the blank.

Calculate the percentage content of $C_{21}H_{28}O_5$ by comparison with prednisolone RS, similarly and concurrently examined.

Uniformity of content

For tablets containing 1 mg of Prednisolone. Individually transfer 10 powdered tablets to 10 separate 100-ml volumetric flasks, add 50 ml of ethanol (~750 g/l) TS, shake, and dilute to volume with the same solvent.

For tablets containing 5 mg of Prednisolone. Individually transfer 10 powdered tablets to 10 separate 100-ml volumetric flasks, add 50 ml of ethanol (~750 g/l) TS, shake, and dilute to volume with the same solvent. Dilute 2.0 ml to 10 ml with ethanol (~750 g/l) TS. Measure the absorbance of a 1-cm layer of the solutions at the maximum at about 242 nm.

Calculate the tablet content of $C_{21}H_{28}O_5$ in mg by comparison with prednisolone RS. The tablets comply with the test for "Uniformity of content for single-dose preparations" (Vol. 4, p. 46).

Pyranteli embonatis compressi

Pyrantel embonate tablets

Category. Anthelmintic drug.

Additional information. Strength in the current WHO Model list of essential drugs: 250 mg of pyrantel.

Requirements

Complies with the monograph for "Tablets" (see Vol. 4, p. 26).

Pyrantel embonate tablets contain not less than **90.0%** and not more than **110.0%** of the amount of $C_{11}H_{14}N_2S, C_{23}H_{16}O_6$ stated on the label.

Identity tests

- *Either test A alone or tests B, C, and D may be applied.*

To a quantity of the powdered tablets equivalent to about 0.05 g of Pyrantel embonate add a mixture of 10 ml of chloroform R, 10 ml of methanol R, and about 1 ml of ammonia (~260 g/l) TS, shake, and filter. Evaporate the filtrate to

dryness on a water-bath, dissolve in a small volume of methanol R, and allow to recrystallize. Separate the crystals, dry at 80 °C for 2 hours, and use the dried crystals for the “Identity tests” and “Related substances”.

- A. Carry out the examination with the dried crystals as described under “Spectrophotometry in the infrared region” (Vol. 1, p. 40). The infrared absorption spectrum is concordant with the spectrum obtained from pyrantel embonate RS or with the *reference spectrum* of pyrantel embonate.
- B. See the test described below under “Related substances”. The principal spot obtained with solution A corresponds in position, appearance, and intensity with that obtained with solution B.
- C. Dissolve 5 mg of the dried crystals in 1.0 ml of hydrochloric acid (~70 g/l) TS and add 1.0 ml of formaldehyde/sulfuric acid TS; a violet-red colour is produced.
- D. Dissolve about 2 mg of the dried crystals in 2 ml of sulfuric acid (~1760 g/l) TS; a yellow colour is produced which changes to orange and finally to red.

Related substances. Carry out the test as described under “Thin-layer chromatography” (Vol. 1, p. 83), using silica gel R2 as the coating substance and a mixture of 20 volumes of ethyl acetate R, 5 volumes of methanol R, and 1.5 volumes of diethylamine R as the mobile phase. Apply separately to the plate 100 µl of each of 3 solutions in a mixture of 5 volumes of chloroform R, 5 volumes of methanol R, and 0.5 volume of ammonia (~260 g/l) TS containing (A) 20 mg of the dried crystals per ml, (B) 20 mg pyrantel embonate RS per ml, and (C) 0.20 mg of the dried crystals per ml. After removing the plate from the chromatographic chamber, allow it to dry in a current of air for 10 minutes, and examine the chromatogram in ultraviolet light (254 nm).

Any spot obtained with solution A, other than the principal spot, is not more intense than that obtained with solution C.

Assay

Note: The operations described below must be carried out in subdued light and without any prolonged interruptions, preferably using low-actinic glassware.

Weigh and powder 20 tablets. To a quantity of the powdered tablets equivalent to about 0.1 g add 10 ml of dioxan R and 10 ml of ammonia (100 g/l) TS, and shake for 10 minutes. Dilute to 100 ml with perchloric acid (~140 g/l) TS, filter, discard the first 10 ml of the filtrate, and transfer 5 ml of the subsequent filtrate to a 50-ml volumetric flask. Dilute to volume with perchloric acid (~140 g/l) TS and mix. Transfer 25 ml to a 250-ml separatory funnel, add 100 ml of chloroform R, and shake well. Drain off the chloroform layer into a

second separatory funnel. Repeat the extraction of the aqueous phase with a second 100-ml portion of chloroform R, and combine the chloroform extracts into the same separatory funnel. Add 40 ml of hydrochloric acid (0.05 mol/l) VS to the combined chloroform extracts and shake well. Drain off the chloroform phase into a third separatory funnel and extract with a further 40-ml portion of hydrochloric acid (0.05 mol/l) VS, discarding the chloroform phase. Combine the aqueous phases in a 100-ml volumetric flask, rinse the separatory funnel draining into the volumetric flask, and dilute to volume with hydrochloric acid (0.05 mol/l) VS. Measure the absorbance of a 1-cm layer at the maximum at about 311 nm against a solvent cell containing hydrochloric acid (0.05 mol/l) VS.

Calculate the percentage content of $C_{11}H_{14}N_2S$, $C_{23}H_{16}O_6$ by comparison with pyrantel embonate RS, similarly and concurrently examined.

Monographs for
antimalarial drugs

Artemetherum

Artemether

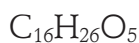
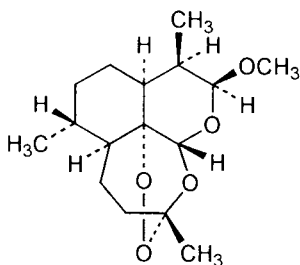

Relative molecular mass. 298.4

Chemical name. (3*R*,5*aS*,6*R*,8*aS*,9*R*,10*S*,12*R*,12*aR*)-Decahydro-10-methoxy-3,6,9-trimethyl-3,12-epoxy-12*H*-pyrano[4,3-*j*]-1,2-benzodioxepin; CAS Reg. No. 71963-77-4.

Description. White crystals or a white, crystalline powder.

Solubility. Practically insoluble in water; very soluble in dichloromethane R and acetone R; freely soluble in ethyl acetate R and dehydrated ethanol R.

Category. Antimalarial drug.

Storage. Artemether should be kept in a tightly closed container, protected from light and stored in a cool place.

Labelling. The designation Artemether for parenteral use indicates that the substance complies with the additional requirements and may be used for parenteral administration.

Additional information. The parenteral form is normally intended for intramuscular administration.

Requirements

Artemether contains not less than **97.0%** and not more than the equivalent of **102.0%** of $\text{C}_{16}\text{H}_{26}\text{O}_5$ using Assay method A, and not less than **98.0%** and not more than the equivalent of **102.0%** of $\text{C}_{16}\text{H}_{26}\text{O}_5$ using Assay method B, both calculated with reference to the dried substance.

Identity tests

- *Either tests A and B or tests B, C, and D may be applied.*
- A. Carry out the examination as described under “Spectrophotometry in the infrared region” (Vol. 1, p. 40). The infrared absorption spectrum is concordant with the spectrum obtained from artemether RS or with the *reference spectrum* of artemether.
- B. See the test described below under “Related substances test B”. The principal spot obtained with solution D corresponds in position, appearance, and intensity with that obtained with solution E.
- C. To 30 mg add about 1 ml of dehydrated ethanol R and about 0.1 g of potassium iodide R. Heat the mixture on a water-bath; a yellow colour is produced.
- D. Dissolve 30 mg in 6.0 ml of dehydrated ethanol R. Place a few drops of the mixture on a white porcelain dish and add 1 drop of vanillin/sulfuric acid TS1; a pink colour is produced.

Melting range. 86.0–90.0 °C.

Specific optical rotation. Use a 10 mg/ml solution in dehydrated ethanol R; $[\alpha]_{\text{D}}^{20^{\circ}\text{C}} = +166^{\circ}$ to $+173^{\circ}$.

Sulfated ash. Not more than 1.0 mg/g.

Loss on drying. Dry over phosphorus pentoxide R under reduced pressure (not exceeding 2.67 kPa or 20 mm of mercury); it loses not more than 5.0 mg/g.

Related substances

- *Either test A or test B may be applied.*
- A. Carry out the test as described under “High-performance liquid chromatography” (p. 257), using the conditions given below under Assay method A.

Inject alternately 20 µl each of solutions A and C.

Measure the areas of the peak responses obtained in the chromatograms from solutions A and C, and calculate the content of the related substances as a percentage. In the chromatogram obtained with solution A, the area of any peak, other than the principal peak, is not greater than that obtained with solution C (0.5%). Not more than one peak is greater than half the area of the principal peak obtained with solution C (0.25%). The sum of the areas of all the peaks, other than the principal peak, is not greater than

twice the area of the principal peak obtained with solution C (1.0%). Disregard any peak with an area less than 0.1 times that of the principal peak in the chromatogram obtained with solution C.

- B. Carry out the test as described under “Thin-layer chromatography” (Vol. 1, p. 83), using silica gel R1 as the coating substance and a mixture of 7 volumes of light petroleum R1 and 3 volumes of ethyl acetate R as the mobile phase. Apply separately to the plate 10 µl of each of the following 5 solutions in acetone R containing (A) 10 mg of Artemether per ml, (B) 0.05 mg of Artemether per ml, (C) 0.025 mg of Artemether per ml, (D) 0.10 mg of Artemether per ml, and (E) 0.10 mg of artemether RS per ml. After removing the plate from the chromatographic chamber, allow it to dry in air, and spray with vanillin/sulfuric acid TS1. Examine the chromatogram in daylight.

Any spot obtained with solution A, other than the principal spot, is not more intense than that obtained with solution B (0.5%). Furthermore, not more than one such spot is more intense than that obtained with solution C (0.25%).

Assay

- *Either method A or method B may be applied.*
- A. Determine by “High performance liquid chromatography” (p. 257), using a stainless steel column (25 cm × 4 mm) packed with *stationary phase A* (5 µm). As the mobile phase, use a mixture of 62 volumes of acetonitrile R and 38 volumes of water.

Prepare the following solutions in the mobile phase: solution (A) 10 mg of Artemether per ml; solution (B) 10 mg of artemether RS per ml; and for solution (C) dilute solution A to obtain a concentration equivalent to 0.05 mg of Artemether per ml.

Operate with a flow rate of 1.5 ml per minute. As a detector use an ultraviolet spectrophotometer set at a wavelength of about 216 nm.

Inject alternately 20 µl each of solutions A and B.

Measure the areas of the peak responses obtained in the chromatograms from solutions A and B, and calculate the percentage content of C₁₆H₂₆O₅ with reference to the dried substance.

- B. Dissolve about 0.050 g of Artemether, accurately weighed, in sufficient dehydrated ethanol R to produce 100 ml. Dilute 2 ml of this solution to 100 ml with hydrochloric acid/ethanol (1 mol/l) VS. Stopper the flask and place it in a water-bath at 55 °C for 5 hours. Allow to cool to room temperature.

Measure the absorbance of this solution in a 1-cm layer at the maximum at about 254 nm. Calculate the percentage content of $C_{16}H_{26}O_5$ by comparison with artemether RS, similarly and concurrently examined, and with reference to the dried substance.

Additional requirement for Artemether for parenteral use

Complies with the monographs for "Parenteral preparations" (see Vol. 4, p. 36), "Test for extractable volume for parenteral preparations" (see p. 27), and "Visual inspection of particulate matter in injectable preparations" (see p. 33).

Artemetheri capsulae

Artemether capsules

Category. Antimalarial drug.

Storage. Artemether capsules should be kept in a hermetically closed container and stored in a cool place.

Additional information. Available strengths: 40 mg, 50 mg.

Requirements

Complies with the monograph for "Capsules" (see Vol. 4, p. 32).

Artemether capsules contain not less than **90.0%** and not more than **110.0%** of the amount of $C_{16}H_{26}O_5$ stated on the label.

Identity tests

- *Either tests A and B, or tests B, C, and D may be applied.*
- A. To a quantity of the contents of the capsules equivalent to 0.040 g of Artemether add 40 ml of acetone R, shake to dissolve, and filter. Evaporate the filtrate at low temperature and dry overnight over desiccant silica gel R. Carry out the examination with the residue as described under "Spectrophotometry in the infrared region" (Vol. 1, p. 40). The infrared absorption spectrum is concordant with the spectrum obtained from artemether RS or with the *reference spectrum* of artemether.
- B. See the test described below under "Related substances test B". The principal spot obtained with solution D corresponds in position, appearance, and intensity with that obtained with solution E.

- C. To a quantity of the contents of the capsules equivalent to 0.08 g of Artemether add 40 ml of dehydrated ethanol R, shake to dissolve, and filter. Evaporate half of the filtrate to about 1 ml (keep the remaining filtrate for test D), add 0.10 g of potassium iodide R and heat; a yellow colour is produced.
- D. Evaporate the remaining filtrate from test C on a water-bath to a volume of about 5 ml. Place a few drops of the mixture on a white porcelain dish and add 1 drop of vanillin/sulfuric acid TS1; a pink colour is produced.

Related substances

- *Either test A or test B may be applied.*
- A. Carry out the test as described under “High-performance liquid chromatography” (p. 257), using the conditions given below under Assay method A.

Inject alternately 20 µl each of solutions A and C.

Measure the areas of the peak responses obtained in the chromatograms from solutions A and C, and calculate the content of the related substances as a percentage. In the chromatogram obtained with solution A, the area of any peak, other than the principal peak, is not greater than that obtained with solution C (0.5%). Not more than one peak is greater than half the area of the principal peak obtained with solution C (0.25%). The sum of the areas of all the peaks, other than the principal peak, is not greater than twice the area of the principal peak obtained with solution C (1.0%). Disregard any peak with an area less than 0.1 times the area of the principal peak in the chromatogram obtained with solution C.

- B. Carry out the test as described under “Thin-layer chromatography” (Vol. 1, p. 83), using silica gel R1 as the coating substance and a mixture of 7 volumes of light petroleum R1 and 3 volumes of ethyl acetate R as the mobile phase. Apply separately to the plate 10 µl of each of the following 5 solutions in acetone R. For solution (A) shake a quantity of the contents of the capsules equivalent to about 20 mg of Artemether with 2 ml of acetone R, filter, and use the filtrate. Prepare similarly solution (B) with the equivalent of about 0.05 mg of Artemether per ml, solution (C) with the equivalent of about 0.025 mg of Artemether per ml, and solution (D) with the equivalent of about 0.10 mg of Artemether per ml. For solution (E) use 0.10 mg of artemether RS per ml. After removing the plate from the chromatographic chamber, allow it to dry in air, and spray with vanillin/sulfuric acid TS1. Examine the chromatogram in daylight.

Any spot obtained with solution A, other than the principal spot, is not more intense than that obtained with solution B (0.5%). Furthermore, not more

than one such spot is more intense than that obtained with solution C (0.25%).

Assay

- Either method A or method B may be applied.
- A. Determine by “High-performance liquid chromatography” (p. 257), using a stainless steel column (25 cm × 4 mm) packed with *stationary phase A* (5 μm). As the mobile phase, use a mixture of 62 volumes of acetonitrile R and 38 volumes of water.

Prepare the following solutions in the mobile phase. For solution (A) mix the contents of 20 capsules, shake a quantity equivalent to about 0.05 g of Artemether, accurately weighed, with 2 ml of acetone R, and filter. Evaporate the filtrate to dryness and dissolve the residue in 5 ml of the mobile phase. For solution (B) use 10 mg of artemether RS per ml, and for solution (C) dilute a suitable volume of solution A to obtain a concentration equivalent to 0.05 mg of Artemether per ml.

Operate with a flow rate of 1.5 ml per minute. As a detector use an ultra-violet spectrophotometer set at a wavelength of about 216 nm.

Inject alternately 20 μl each of solutions A and B.

Measure the areas of the peak responses obtained in the chromatograms from solutions A and B, and calculate the percentage content of C₁₆H₂₆O₅.

- B. Mix the contents of 20 capsules and transfer a quantity equivalent to about 13 mg of Artemether, accurately weighed, to a 100-ml volumetric flask and dilute to volume with dehydrated ethanol R. Shake the flask for 15 minutes and filter, discarding the first 10 ml of the filtrate. Accurately measure 5 ml of the clear filtrate into a 50-ml volumetric flask and dilute to volume with hydrochloric acid/ethanol (1 mol/l) VS. Stopper the flask and place it in a water-bath at 55 °C for 5 hours. Allow to cool to room temperature. For the blank use 5 ml of dehydrated ethanol R diluted with sufficient hydrochloric acid/ethanol (1 mol/l) VS to produce 50 ml.

Measure the absorbance of a 1-cm layer at the maximum at about 254 nm against a solvent cell containing the blank. Calculate the percentage content of C₁₆H₂₆O₅ in the capsules being examined by comparison with artemether RS, similarly and concurrently examined.

Dissolution test. (See Preface, p. vii.)

Artemetheri compressi

Artemether tablets

Category. Antimalarial drug.

Additional information. Available strengths: 40 mg, 50 mg.

Requirements

Complies with the monograph for "Tablets" (see Vol. 4, p. 26).

Artemether tablets contain not less than **90.0%** and not more than **110.0%** of the amount of $C_{16}H_{26}O_5$ stated on the label.

Identity tests

- *Either tests A and B, or tests B, C, and D may be applied.*
- A. To a quantity of the powdered tablets equivalent to 0.040 g of Artemether add 40 ml of acetone R, shake to dissolve, and filter. Evaporate the filtrate at low temperature and dry overnight over desiccant silica gel R. Carry out the examination with the residue as described under "Spectrophotometry in the infrared region" (Vol. 1, p. 40). The infrared absorption spectrum is concordant with the spectrum obtained from artemether RS or with the *reference spectrum* of artemether.
- B. See the test described below under "Related substances test B". The principal spot obtained with solution D corresponds in position, appearance, and intensity with that obtained with solution E.
- C. To a quantity of the powdered tablets equivalent to 0.08 g of Artemether add 40 ml of dehydrated ethanol R, shake to dissolve, and filter. Evaporate half of the filtrate to about 1 ml (keep the remaining filtrate for test D), add 0.10 g of potassium iodide, and heat; a yellow colour is produced.
- D. Evaporate the remaining filtrate from test C on a water-bath to a volume of about 5 ml. Place a few drops of the mixture on a white porcelain dish and add 1 drop of vanillin/sulfuric acid TS1; a pink colour is produced.

Related substances

- *Either test A or test B may be applied.*
- A. Carry out the test as described under "High-performance liquid chromatography" (p. 257), using the conditions given below under Assay method A.

Inject alternately 20 μ l each of solutions A and C.

Measure the areas of the peak responses obtained in the chromatograms from solutions A and C, and calculate the content of the related substances as a percentage. In the chromatogram obtained with solution A, the area of any peak, other than the principal peak, is not greater than that obtained with solution C (0.5%). Not more than one peak is greater than half the area of the principal peak obtained with solution C (0.25%). The sum of the areas of all the peaks, other than the principal peak, is not greater than twice the area of the principal peak obtained with solution C (1.0%). Disregard any peak with an area less than 0.1 times the area of the principal peak in the chromatogram obtained with solution C.

- B. Carry out the test as described under “Thin-layer chromatography” (Vol. 1, p. 83), using silica gel R1 as the coating substance and a mixture of 7 volumes of light petroleum R1 and 3 volumes of ethyl acetate R as the mobile phase. Apply separately to the plate 10 µl of each of the following 5 solutions in acetone R. For solution (A) shake a quantity of the powdered tablets equivalent to about 20 mg of Artemether with 2 ml of acetone R, filter, and use the filtrate. Prepare similarly solution (B) with the equivalent of about 0.05 mg of Artemether per ml, solution (C) with the equivalent of about 0.025 mg of Artemether per ml, and solution (D) with the equivalent of about 0.10 mg of Artemether per ml. For solution (E) use 0.10 mg of artemether RS per ml. After removing the plate from the chromatographic chamber, allow it to dry in air, and spray with vanillin/sulfuric acid TS1. Examine the chromatogram in daylight.

Any spot obtained with solution A, other than the principal spot, is not more intense than that obtained with solution B (0.5%). Furthermore, not more than one such spot is more intense than that obtained with solution C (0.25%).

Assay

- *Either method A or method B may be applied.*
- A. Determine by “High-performance liquid chromatography” (p. 257), using a stainless steel column (25 cm × 4 mm) packed with *stationary phase A* (5 µm). As the mobile phase, use a mixture of 62 volumes of acetonitrile R and 38 volumes of water.

Prepare the following solutions in the mobile phase. For solution (A) weigh and powder 20 tablets, shake a quantity of the powder equivalent to about 0.05 g of Artemether, accurately weighed, with 2 ml of acetone R, and filter. Evaporate the filtrate to dryness and dissolve the residue in 5 ml of the mobile phase. For solution (B) use 10 mg of artemether RS per ml, and for solution (C) dilute a suitable volume of solution A to obtain a concentration equivalent to 0.05 mg of Artemether per ml.

Operate with a flow rate of 1.5 ml per minute. As a detector use an ultraviolet spectrophotometer set at a wavelength of about 216 nm.

Inject alternately 20 µl each of solutions A and B.

Measure the areas of the peak responses obtained in the chromatograms from solutions A and B, and calculate the percentage content of $C_{16}H_{26}O_5$.

- B. Weigh and powder 20 tablets. Transfer a quantity of the powder equivalent to about 13 mg of Artemether, accurately weighed, to a 100-ml volumetric flask and dilute to volume with dehydrated ethanol R. Shake the flask for 15 minutes and filter, discarding the first 10 ml of the filtrate. Accurately measure 5 ml of the clear filtrate into a 50-ml volumetric flask and dilute to volume with hydrochloric acid/ethanol (1 mol/l) VS. Stopper the flask and place it in a water-bath at 55 °C for 5 hours. Allow to cool to room temperature. For the blank use 5 ml of dehydrated ethanol R diluted with sufficient hydrochloric acid/ethanol (1 mol/l) VS to produce 50 ml.

Measure the absorbance of a 1-cm layer at the maximum at about 254 nm against a solvent cell containing the blank. Calculate the percentage content of $C_{16}H_{26}O_5$ in the tablets being examined by comparison with artemether RS, similarly and concurrently examined.

Dissolution test. (See Preface, p. vii.)

Artemetheri injectio

Artemether injection

Composition. Artemether injection is a sterile solution of artemether in a suitable oil for injection.

Description. A clear, colourless or almost colourless, oily solution.

Category. Antimalarial drug.

Storage. Artemether injection should be kept protected from light and stored in a cool place.

Labelling. The oil used in the formulation should be indicated.

Additional information. Strength in the current WHO Model list of essential drugs: 80 mg/ml in 1-ml ampoule; other available strengths: 40 mg/ml (paediatric formulation), 60 mg/ml, 100 mg/ml (adult formulation).

Artemether injection is normally intended for intramuscular administration. The solution is sterilized by a suitable method (see "Methods of sterilization", Vol. 4, p. 18).

Requirements

Complies with the monographs for "Parenteral preparations" (see Vol. 4, p. 36), "Test for extractable volume for parenteral preparations" (see p. 27), "Test for bacterial endotoxins" (see p. 30), and "Visual inspection of particulate matter in injectable preparations" (see p. 33).

Artemether injection contains not less than **95.0%** and not more than **105.0%** of the amount of $C_{16}H_{26}O_5$ stated on the label.

Identity tests

- *Either tests A and B or tests B and C may be applied.*
- A. To a volume of the injection equivalent to 0.050 g of Artemether add 25 ml of acetone R, mix, and filter. Evaporate the filtrate at low temperature and dry overnight over desiccant silica gel R. Carry out the examination as described under "Spectrophotometry in the infrared region" (Vol. 1, p. 40). The infrared absorption spectrum is concordant with the spectrum obtained from artemether RS or with the *reference spectrum* of artemether.
- B. See the test described below under "Related substances test B". The principal spot obtained with solution D corresponds in position, appearance, and intensity with that obtained with solution E.
- C. To a volume of Artemether injection equivalent to about 30 mg of Artemether add 6 ml of dehydrated ethanol R. Place a few drops of the mixture on a white porcelain dish and add 1 drop of vanillin/sulfuric acid TS1; a pink colour is produced.

Related substances

- *Either test A or test B may be applied.*
- A. *Note:* This test cannot be performed if arachis oil is present in the formulation.

Carry out the test as described under "High-performance liquid chromatography" (p. 264), using the conditions given below under Assay method A.

Inject alternately 20 μ l each of solutions A and C.

Measure the areas of the peak responses obtained in the chromatograms from solutions A and C, and calculate the content of the related substances

as a percentage. In the chromatogram obtained with solution A, the area of any peak, other than the principal peak, is not greater than that obtained with solution C (0.5%). Not more than one peak is greater than half the area of the principal peak obtained with solution C (0.25%). The sum of the areas of all the peaks, other than the principal peak, is not greater than twice the area of the principal peak obtained with solution C (1.0%). Disregard any peak with an area less than 0.1 times the area of the principal peak in the chromatogram obtained with solution C.

- B. Carry out the test as described under “Thin-layer chromatography” (Vol. 1, p. 83), using silica gel R1 as the coating substance and a mixture of 7 volumes of light petroleum R1 and 3 volumes of ethyl acetate R as the mobile phase. Apply separately to the plate 10 µl of each of the following 5 solutions in acetone R. For solution (A) dilute a volume of the injection with acetone R to obtain a concentration equivalent to 10 mg of Artemether per ml. Prepare similarly solution (B) with the equivalent of about 0.05 mg of Artemether per ml, solution (C) with the equivalent of about 0.025 mg of Artemether per ml, and solution (D) with the equivalent of about 0.10 mg of Artemether per ml. For solution (E) use 0.10 mg of artemether RS per ml. After removing the plate from the chromatographic chamber, allow it to dry in air, and spray with vanillin/sulfuric acid TS1. Examine the chromatogram in daylight.

Any spot obtained with solution A, other than the principal spot, is not more intense than that obtained with solution B (0.5%). Furthermore, not more than one such spot is more intense than that obtained with solution C (0.25%).

Assay

- *Either method A or method B may be applied.*
- A. Determine by “High-performance liquid chromatography” (p. 257), using a stainless steel column (25 cm × 4 mm) packed with *stationary phase A* (5 µm). As the mobile phase, use a mixture of 62 volumes of acetonitrile R and 38 volumes of water.

Prepare the following solutions in the mobile phase. For solution (A) dilute a volume of the injection to obtain a concentration equivalent to 10 mg of Artemether per ml, for solution (B) use 10 mg of artemether RS per ml, and for solution (C) dilute a suitable volume of solution A to obtain a concentration equivalent to 0.05 mg of Artemether per ml.

Operate with a flow rate of 1.5 ml per minute. As a detector use an ultraviolet spectrophotometer set at a wavelength of about 216 nm.

Inject alternately 20 µl each of solutions A and B.

Measure the areas of the peak responses obtained in the chromatograms from solutions A and B, and calculate the percentage content of $C_{16}H_{26}O_5$.

- B. Dilute an accurately measured volume of the injection equivalent to about 0.08 g with sufficient ethanol R to produce 100 ml. Dilute 5 ml of this solution with the same solvent to 50 ml and mix. Transfer a further 5 ml of the diluted solution to a 50-ml volumetric flask and dilute to volume with hydrochloric acid/ethanol (1 mol/l) VS. Stopper the flask and place it in a water-bath at $55 \pm 1^\circ\text{C}$ for 5 hours. Allow to cool to room temperature.

Measure the absorbance of this solution in a 1-cm layer at the maximum at about 254 nm. (*Note:* If arachis oil is used in the formulation of Artemether injection subtract the value of 0.025 from the absorbance value determined; the correction in absorbance value for other oils would have to be established.) Calculate the percentage content of $C_{16}H_{26}O_5$ in the formulation being examined by comparison with artemether RS, similarly and concurrently examined.

Artemisininum

Artemisinin

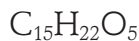
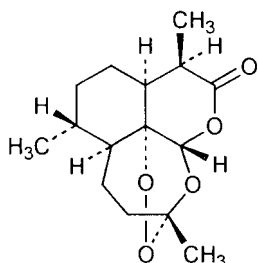

Relative molecular mass. 282.3

Chemical name. (3*R*,5*aS*,6*R*,8*aS*,9*R*,12*S*,12*aR*)-Octahydro-3,6,9-trimethyl-3,12-epoxy-12*H*-pyrano[4.3-*j*]-1,2-benzodioxepin-10(3*H*)-one; CAS Reg. No. 63968-64-9.

Description. Colourless needles or a white, crystalline powder.

Solubility. Practically insoluble in water; very soluble in dichloromethane R; freely soluble in acetone R and ethyl acetate R; soluble in glacial acetic acid R, methanol R and ethanol (~750 g/l) TS.

Category. Antimalarial drug.

Storage. Artemisinin should be kept in a well-closed container, protected from light and stored in a cool place.

Requirements

Artemisinin contains not less than **97.0%** and not more than the equivalent of **102.0%** of $C_{15}H_{22}O_5$ using Assay method A, and not less than **98.0%** and not more than the equivalent of **102.0%** of $C_{15}H_{22}O_5$ using Assay method B, both calculated with reference to the dried substance.

Identity tests

- *Either test A alone or tests B, C, and D may be applied.*
- A. Carry out the examination as described under “Spectrophotometry in the infrared region” (Vol. 1, p. 40). The infrared absorption spectrum is concordant with the spectrum obtained from artemisinin RS or with the *reference spectrum* of artemisinin.
- B. See the test described below under “Related substances test B”. The principal spot obtained with solution D corresponds in position, appearance, and intensity with that obtained with solution E.
- C. Dissolve 5 mg in about 0.5 ml of dehydrated ethanol R, add about 0.5 ml of hydroxylamine hydrochloride TS2 and 0.25 ml of sodium hydroxide (~80 g/l) TS. Heat the mixture in a water-bath to boiling, cool, add 2 drops of hydrochloric acid (~70 g/l) TS and 2 drops of ferric chloride (50 g/l) TS; a deep violet colour is immediately produced.
- D. Dissolve 5 mg in about 0.5 ml of dehydrated ethanol R, add 1.0 ml of potassium iodide (80 g/l) TS, 2.5 ml of sulfuric acid (~100 g/l) TS and 4 drops of starch TS; a violet colour is immediately produced.

Melting range. 151–154°C.

Specific optical rotation. Use a 10 mg/ml solution in dehydrated ethanol R; $[\alpha]_D^{20^\circ} = +75^\circ$ to $+78^\circ$.

Sulfated ash. Not more than 1.0 mg/g.

Loss on drying. Dry to constant mass at 80°C; it loses not more than 5.0 mg/g.

Related substances

- *Either test A or test B may be applied.*

- A. Carry out the test as described under “High-performance liquid chromatography” (p. 257), using a stainless steel column (10 cm × 4.6 mm) packed with *stationary phase A* (3 μm). The mobile phases for gradient elution consist of a mixture of acetonitrile and water, using the conditions shown in the following table:

Time (min)	Mobile phase A (% v/v of acetonitrile)	Mobile phase B (% v/v of water)	Comment
0–17	60	40	Isocratic
17–30	60 ⇒ 100	40 ⇒ 0	Linear gradient
30–35	100 ⇒ 60	0 ⇒ 40	Return to initial conditions
35–45	60	40	Isocratic – re-equilibration

Prepare the following solutions. For solution (A) use 10 mg of Artemisinin per ml in a mixture of 8 volumes of acetonitrile R and 2 volumes of water, and for solution (B) use 50 μg of Artemisinin per ml in a mixture of 6 volumes of acetonitrile R and 4 volumes of water.

For the system suitability test prepare solution (C) containing 1 mg of artemisinin RS per ml and 1 mg of artemimol RS per ml in a mixture of 8 volumes of acetonitrile R and 2 volumes of water.

Operate with a flow rate of 0.6 ml per minute. As a detector use an ultraviolet spectrophotometer set at a wavelength of about 216 nm.

Inject alternately 20 μl each of solutions A, B, and C.

Measure the areas of the peak responses obtained in the chromatograms from solutions A and B, and calculate the content of the related substances as a percentage. In the chromatogram obtained with solution A, the area of any peak, other than the principal peak, is not greater than that obtained with solution B (0.5%). Not more than one peak is greater than half the area of the principal peak obtained with solution B (0.25%). The sum of the areas of all peaks, other than the principal peak, is not greater than twice the area of the principal peak obtained with solution B (1.0%). Disregard any peak with an area less than 0.1 times the area of the principal peak in the chromatogram obtained with solution B. The test is not valid unless the relative retention of α-artenimol compared with artemisinin is about 0.6, and the resolution between the peaks is not less than 2.0.

- B. Carry out the test as described under “Thin-layer chromatography” (Vol. 1, p. 83), using silica gel R1 as the coating substance and a mixture of equal

volumes of light petroleum R1 and ether R as the mobile phase. Apply separately to the plate 10 µl of each of the following 5 solutions in toluene R containing (A) 10 mg of Artemisinin per ml, (B) 0.05 mg of Artemisinin per ml, (C) 0.025 mg of Artemisinin per ml, (D) 0.10 mg of Artemisinin per ml, and (E) 0.10 mg of artemisinin RS per ml. After removing the plate from the chromatographic chamber, allow it to dry in air, spray with anisaldehyde/sulfuric acid TS, and heat the plate to 105 °C for 7 minutes. Examine the chromatogram in daylight.

Any spot obtained with solution A, other than the principal spot, is not more intense than that obtained with solution B (0.5%). Furthermore, not more than one such spot is more intense than that obtained with solution C (0.25%).

Assay

- *Either method A or method B may be applied.*

A. Determine by “High-performance liquid chromatography” (p. 257), using a stainless steel column (10 cm × 4.6 mm) packed with *stationary phase A* (3 µm). As the mobile phase, use a mixture of 6 volumes of acetonitrile R and 4 volumes of water.

Prepare the following solutions in the mobile phase: solution (A) 1.0 mg of Artemisinin per ml; and solution (B) 1.0 mg of artemisinin RS per ml.

For the system suitability test prepare solution (C) containing 1 mg of artemisinin RS per ml and 1 mg of artemimol RS per ml in a mixture of 8 volumes of acetonitrile R and 2 volumes of water.

Operate with a flow rate of 0.6 ml per minute. As a detector use an ultraviolet spectrophotometer set at a wavelength of about 216 nm.

Inject alternately 20 µl each of solutions A, B, and C.

The test is not valid unless the relative retention of α-artenimol compared with artemisinin is about 0.6, and the resolution between the peaks is not less than 2.0.

Measure the areas of the peak responses obtained in the chromatograms from solutions A and B, and calculate the percentage content of C₁₅H₂₂O₅ with reference to the dried substance.

B. Dissolve about 0.05 g of Artemisinin, accurately weighed, in sufficient ethanol (~750 g/l) TS to produce 100 ml, and dilute 10 ml to 100 ml with the same solvent. Accurately transfer 10 ml to a 50-ml volumetric flask, dilute to volume with sodium hydroxide (0.05 mol/l) VS, mix thor-

oughly, and warm to 50°C in a water-bath for 30 minutes. Cool to room temperature.

Measure the absorbance of a 1-cm layer at the maximum at about 292 nm against a solvent cell containing a blank prepared with 10 ml of ethanol (~750 g/l) TS diluted with sufficient sodium hydroxide (0.05 mol/l) VS to produce 50 ml. Calculate the percentage content of $C_{15}H_{22}O_5$ in the substance being tested by comparison with artemisinin RS, similarly and concurrently examined, and with reference to the dried substance.

Artemisinini capsulae

Artemisinin capsules

Category. Antimalarial drug.

Storage. Artemisinin capsules should be kept in a cool place.

Additional information. Available strength: 250 mg.

Requirements

Complies with the monograph for "Capsules" (see Vol. 4, p. 32).

Artemisinin capsules contain not less than **90.0%** and not more than **110.0%** of the amount of $C_{15}H_{22}O_5$ stated on the label.

Identity tests

- *Either test A alone or tests B, C, and D may be applied.*
- A. To a quantity of the contents of the capsules equivalent to 0.040 g of Artemisinin add 40 ml of acetone R, shake to dissolve, and filter. Evaporate the filtrate at low temperature and dry overnight over desiccant silica gel R. Carry out the examination with the residue as described under "Spectrophotometry in the infrared region" (Vol. 1, p. 40). The infrared absorption spectrum is concordant with the spectrum obtained from artemisinin RS or with the *reference spectrum* of artemisinin.
- B. See the test described below under "Related substances test B". The principal spot obtained with solution D corresponds in position, appearance, and intensity with that obtained with solution E.
- C. To a quantity of the contents of the capsules equivalent to 10 mg of Artemisinin add 20 ml of dehydrated ethanol R, shake to dissolve, filter, and

evaporate to dryness. To half of the residue (keep the remaining residue for test D) add 0.5 ml of dehydrated ethanol R, 1.0 ml of potassium iodide (80 g/l) TS, 2.5 ml of sulfuric acid (~100 g/l) TS, and 4 drops of starch TS; a violet colour is immediately produced.

- D. Evaporate the remaining filtrate from test C to dryness on a water-bath. Dissolve the residue in 0.5 ml of dehydrated ethanol R, add about 0.5 ml of hydroxylamine hydrochloride TS2 and 0.25 ml of sodium hydroxide (~80 g/l) TS. Heat the mixture in a water-bath to boiling, cool, add 2 drops of hydrochloric acid (~70 g/l) TS and 2 drops of ferric chloride (50 g/l) TS; a deep violet colour is immediately produced.

Related substances

- *Either test A or test B may be applied.*
- A. Carry out the test as described under “High-performance liquid chromatography” (p. 257), using a stainless steel column (10 cm × 4.6 mm) packed with *stationary phase A* (3 μm). The mobile phases for gradient elution consist of a mixture of acetonitrile and water, using the conditions shown in the following table:

Time (min)	Mobile phase A (% v/v of acetonitrile)	Mobile phase B (% v/v of water)	Comment
0–17	60	40	Isocratic
17–30	60 ⇒ 100	40 ⇒ 0	Linear gradient
30–35	100 ⇒ 60	0 ⇒ 40	Return to initial conditions
35–45	60	40	Isocratic – re-equilibration

Prepare the following solutions. For solution (A) mix the contents of 20 capsules, shake a quantity equivalent to about 10 mg of Artemisinin, accurately weighed, with 2 ml of acetone R, and filter. Evaporate the filtrate to dryness and dissolve the residue in 1.0 ml of a mixture of 8 volumes of acetonitrile R and 2 volumes of water.

For solution (B) use 50 μg of Artemisinin per ml in a mixture of 6 volumes of acetonitrile R and 4 volumes of water.

For the system suitability test prepare solution (C) containing 1.0 mg of artemisinin RS per ml and 1.0 mg of artemimol RS per ml in a mixture of 8 volumes of acetonitrile R and 2 volumes of water.

Operate with a flow rate of 0.6 ml per minute. As a detector use an ultraviolet spectrophotometer set at a wavelength of about 216 nm.

Inject alternately 20 µl each of solutions A, B, and C.

The test is not valid unless the relative retention of α -artemimol compared with artemisinin is about 0.6, and the resolution between the peaks is not less than 2.0.

Measure the areas of the peak responses obtained in the chromatograms from solutions A and B, and calculate the content of the related substances as a percentage. In the chromatogram obtained with solution A, the area of any peak, other than the principal peak, is not greater than that obtained with solution B (0.5%). Not more than one peak is greater than half the area of the principal peak obtained with solution B (0.25%). The sum of the areas of all peaks, other than the principal peak, is not greater than twice the area of the principal peak obtained with solution B (1.0%). Disregard any peak with an area less than 0.1 times the area of the principal peak in the chromatogram obtained with solution B.

- B. Carry out the test as described under “Thin-layer chromatography” (Vol. 1, p. 83), using silica gel R1 as the coating substance and a mixture of equal volumes of light petroleum R1 and ether R as the mobile phase. Apply separately to the plate 10 µl of each of the following 5 solutions in toluene R. For solution (A) take a quantity of the contents of the capsules equivalent to about 0.10 g of Artemisinin, add 10 ml of acetone R, shake vigorously, filter into a 10-ml volumetric flask, and dilute to volume with acetone R. Prepare similarly solution (B) containing the equivalent of about 0.05 mg of Artemisinin per ml, solution (C) the equivalent of about 0.025 mg of Artemisinin per ml, and solution (D) with the equivalent of about 0.10 mg of Artemisinin per ml. For solution (E) use 0.10 mg of artemisinin RS per ml. After removing the plate from the chromatographic chamber, allow it to dry in air, spray with anisaldehyde/sulfuric acid TS, and heat the plate to 105 °C for 7 minutes. Examine the chromatogram in daylight.

Any spot obtained with solution A, other than the principal spot, is not more intense than that obtained with solution B (0.5%). Furthermore, not more than one such spot is more intense than that obtained with solution C (0.25%).

Assay

- *Either method A or method B may be applied.*
- A. Determine by “High-performance liquid chromatography” (p. 257), using a stainless steel column (10 cm × 4.6 mm) packed with *stationary phase A* (3 µm). As the mobile phase, use a mixture of 6 volumes of acetonitrile C and 4 volumes of water.

Prepare the following solutions in the mobile phase. For solution (A) mix the contents of 20 capsules, shake a quantity equivalent to about 1.0 mg of Artemisinin, accurately weighed, with 2 ml of acetone R, and filter. Evaporate the filtrate to dryness and dissolve the residue in 1.0 ml. For solution (B) use 1.0 mg of artemisinin RS per ml.

For the system suitability test prepare solution (C) containing 1.0 mg of artemisinin RS per ml and 1.0 mg of artemimol RS per ml in a mixture of 8 volumes of acetonitrile R and 2 volumes of water.

Operate with a flow rate of 0.6 ml per minute. As a detector use an ultraviolet spectrophotometer set at a wavelength of about 216 nm.

Inject alternately 20 μ l each of solutions A, B, and C.

The test is not valid unless the relative retention of α -artemimol compared with artemisinin is about 0.6, and the resolution between the peaks is not less than 2.0.

Measure the areas of the peak responses obtained in the chromatograms from solutions A and B, and calculate the percentage content of $C_{15}H_{22}O_5$.

- B. Mix the contents of 20 capsules and transfer a quantity equivalent to about 0.05 g of Artemisinin, accurately weighed, to a 100-ml volumetric flask and dilute to volume with ethanol (~750 g/l) TS. Shake the flask, filter, and discard the first 20 ml of the filtrate. Dilute 10 ml of the filtrate to 100 ml with the same solvent. Accurately transfer 10 ml to a 50-ml volumetric flask, dilute to volume with sodium hydroxide (0.05 mol/l) VS, mix thoroughly, and warm to 50 °C in a water-bath for 30 minutes. Cool to room temperature.

Measure the absorbance of a 1-cm layer at the maximum at about 292 nm against a solvent cell containing a blank prepared with 10 ml of ethanol (~750 g/l) TS diluted with sufficient sodium hydroxide (0.05 mol/l) VS to produce 50 ml. Calculate the percentage content of $C_{15}H_{22}O_5$ in the substance being tested by comparison with artemisinin RS, similarly and concurrently examined.

Dissolution test. (See Preface, p. vii.)

Artemisinini compressi

Artemisinin tablets

Category. Antimalarial drug.

Storage. Artemisinin tablets should be kept in a cool place.

Additional information. Available strength: 250 mg.

Requirements

Complies with the monograph for "Tablets" (see Vol. 4, p. 26).

Artemisinin tablets contain not less than **90.0%** and not more than **110.0%** of the amount of $C_{15}H_{22}O_5$ stated on the label.

Identity tests

- *Either test A alone or tests B, C, and D may be applied.*
- A. To a quantity of the powdered tablets equivalent to 0.040 g of Artemisinin add 40 ml of acetone R, shake to dissolve, and filter. Evaporate the filtrate at low temperature and dry overnight over desiccant silica gel R. Carry out the examination with the residue as described under "Spectrophotometry in the infrared region" (Vol. 1, p. 40). The infrared absorption spectrum is concordant with the spectrum obtained from artemisinin RS or with the *reference spectrum* of artemisinin.
- B. See the test described below under "Related substances test B". The principal spot obtained with solution D corresponds in position, appearance, and intensity with that obtained with solution E.
- C. To a quantity of the powdered tablets equivalent to 10 mg of Artemisinin add 20 ml of dehydrated ethanol R, shake to dissolve, filter, and evaporate to dryness. To half of the residue (keep the remaining residue for test D) add 0.5 ml of dehydrated ethanol R, 1.0 ml of potassium iodide (80 g/l) TS, 2.5 ml of sulfuric acid (~100 g/l) TS, and 4 drops of starch TS; a violet colour is immediately produced.
- D. Evaporate the remaining filtrate from test C to dryness on a water-bath. Dissolve the residue in 0.5 ml of dehydrated ethanol R, add about 0.5 ml of hydroxylamine hydrochloride TS2 and 0.25 ml of sodium hydroxide (~80 g/l) TS. Heat the mixture in a water-bath to boiling, cool, add 2 drops of hydrochloric acid (~70 g/l) TS and 2 drops of ferric chloride (50 g/l) TS; a deep violet colour is immediately produced.

Related substances

- *Either test A or test B may be applied.*
- A. Carry out the test as described under "High-performance liquid chromatography" (p. 257), using a stainless steel column (10 cm × 4.6 mm) packed with *stationary phase A* (3 μm). The mobile phases for gradient elution

consist of a mixture of acetonitrile and water, using the conditions shown in the following table:

Time (min)	Mobile phase A (% v/v of acetonitrile)	Mobile phase B (% v/v of water)	Comment
0–17	60	40	Isocratic
17–30	60 ⇒ 100	40 ⇒ 0	Linear gradient
30–35	100 ⇒ 60	0 ⇒ 40	Return to initial conditions
35–45	60	40	Isocratic – re-equilibration

Prepare the following solutions. For solution (A) weigh and powder 20 tablets, take a quantity of the powder equivalent to about 10mg of Artemisinin, accurately weighed, add 2ml of acetone R, shake, and filter. Evaporate the filtrate to dryness and dissolve the residue in 1.0ml of a mixture of 8 volumes of acetonitrile R and 2 volumes of water. For solution (B) use 50µg of Artemisinin per ml in a mixture of 6 volumes of acetonitrile R and 4 volumes of water.

For the system suitability test prepare solution (C) containing 1.0mg of artemisinin RS per ml and 1.0mg of artemimol RS per ml in a mixture of 8 volumes of acetonitrile R and 2 volumes of water.

Operate with a flow rate of 0.6ml per minute. As a detector use an ultra-violet spectrophotometer set at a wavelength of about 216nm.

Inject alternately 20µl each of solutions A, B, and C.

The test is not valid unless the relative retention of α-artemimol compared with artemisinin is about 0.6, and the resolution between the peaks is not less than 2.0.

Measure the areas of the peak responses obtained in the chromatograms from solutions A and B, and calculate the content of related substances as a percentage. In the chromatogram obtained with solution A, the area of any peak, other than the principal peak, is not greater than that obtained with solution B (0.5%). Not more than one peak is greater than half the area of the principal peak obtained with solution B (0.25%). The sum of the areas of all peaks, other than the principal peak, is not greater than twice the area of the principal peak obtained with solution B (1.0%). Disregard any peak with an area less than 0.1 times the area of the principal peak in the chromatogram obtained with solution B.

- B. Carry out the test as described under “Thin-layer chromatography” (Vol. 1, p. 83), using silica gel R1 as the coating substance and a mixture of equal volumes of light petroleum R1 and ether R as the mobile phase. Apply separately to the plate 10 µl of each of the following 5 solutions in toluene R. For solution (A) take a quantity of the powdered tablets equivalent to about 0.10 g of Artemisinin, add 10 ml of acetone R, shake vigorously, filter into a 10-ml volumetric flask, and dilute to volume with acetone R. Prepare similarly solution (B) with the equivalent of about 0.05 mg of Artemisinin per ml, solution (C) with the equivalent of about 0.025 mg of Artemisinin per ml, and solution (D) with the equivalent of about 0.10 mg of Artemisinin per ml. For solution (E) use 0.10 mg of artemisinin RS per ml. After removing the plate from the chromatographic chamber, allow it to dry in air, spray with anisaldehyde/sulfuric acid TS, and heat the plate to 105 °C for 7 minutes. Examine the chromatogram in daylight.

Any spot obtained with solution A, other than the principal spot, is not more intense than that obtained with solution B (0.5%). Furthermore, not more than one such spot is more intense than that obtained with solution C (0.25%).

Assay

- *Either method A or method B may be applied.*
- A. Determine by “High-performance liquid chromatography” (p. 257), using a stainless steel column (10 cm × 4.6 mm) packed with *stationary phase A* (3 µm). As the mobile phase, use a mixture of 6 volumes of acetonitrile R and 4 volumes of water.

Prepare the following solutions in the mobile phase. For solution (A) weigh and powder 20 tablets, shake a quantity of the powder equivalent to about 1.0 mg of Artemisinin, accurately weighed, with 2 ml of acetone R, and filter. Evaporate the filtrate to dryness, and dissolve the residue in 1.0 ml. For solution (B) use 1.0 mg of artemisinin RS per ml.

For the system suitability test prepare solution (C) containing 1.0 mg of artemisinin RS per ml and 1.0 mg of artemimol RS per ml in a mixture of 8 volumes of acetonitrile R and 2 volumes of water.

Operate with a flow rate of 0.6 ml per minute. As a detector use an ultraviolet spectrophotometer set at a wavelength of about 216 nm.

Inject alternately 20 µl each of solutions A, B, and C.

The test is not valid unless the relative retention of α -artemimol compared with artemisinin is about 0.6, and the resolution between the peaks is not less than 2.0.

Measure the areas of the peak responses obtained in the chromatograms from solutions A and B, and calculate the percentage content of $C_{15}H_{22}O_5$.

- B. Weigh and powder 20 tablets. Transfer a quantity of the powder equivalent to about 0.05 g of Artemisinin, accurately weighed, to a 100-ml volumetric flask and dilute to volume with ethanol (~750 g/l) TS. Shake the flask, filter, and discard the first 20 ml of the filtrate. Dilute 10 ml of the filtrate to 100 ml with the same solvent. Accurately transfer 10 ml to a 50-ml volumetric flask, dilute to volume with sodium hydroxide (0.05 mol/l) VS, mix thoroughly, and warm to 50 °C in a water-bath for 30 minutes. Cool to room temperature.

Measure the absorbance of a 1-cm layer at the maximum at about 292 nm against a solvent cell containing a blank prepared with 10 ml of ethanol (~750 g/l) TS diluted with sufficient sodium hydroxide (0.05 mol/l) VS to produce 50 ml. Calculate the percentage content of $C_{15}H_{22}O_5$ in the substance being tested by comparison with artemisinin RS, similarly and concurrently examined.

Dissolution test. (See Preface, p. vii.)

Artemotilum

Artemotil

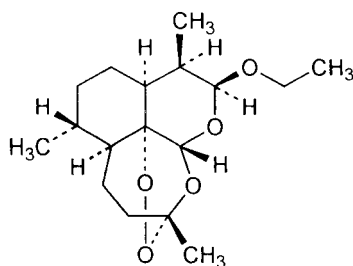

$C_{17}H_{28}O_5$

Relative molecular mass. 312.4

Chemical name. (3*R*,5*aS*,6*R*,8*aS*,9*R*,10*S*,12*R*,12*aR*)-Decahydro-10-ethoxy-3,6,9-trimethyl-3,12-epoxy-12*H*-pyrano[4,3-*j*]-1,2-benzodioxepin; CAS Reg. No. 75887-54-6.

Other names. Arteether, β-arteether.

Description. A white or almost white, crystalline powder.

Solubility. Practically insoluble in water; sparingly soluble in dichloromethane R, ethanol (~750 g/l) TS and methanol R; soluble in arachis oil R and sesame oil R.

Category. Antimalarial drug.

Storage. Artemotil should be kept in a well-closed container, protected from light.

Labelling. The designation Artemotil for parenteral use indicates that the substance complies with the additional requirements and may be used for parenteral administration.

Additional information. The parenteral form is normally intended for intramuscular administration.

Requirements

Artemotil contains not less than **97.0%** and not more than the equivalent of **102.0%** of $C_{17}H_{28}O_5$ calculated with reference to the dried substance.

Identity tests

- *Either tests A and B or tests B, C, and D may be applied.*
- A. Carry out the examination as described under “Spectrophotometry in the infrared region” (Vol. 1, p. 40). The infrared absorption spectrum is concordant with the spectrum obtained from artemotil RS or with the *reference spectrum* of artemotil.
- B. See the test described below under “Related substances test B”. The principal spot obtained with solution D corresponds in position, appearance, and intensity with that obtained with solution E.
- C. To 30 mg add about 1 ml of dehydrated ethanol R and about 0.1 g of potassium iodide R. Heat the mixture on a water-bath; a yellow colour is produced.
- D. Dissolve 30 mg in 6.0 ml of dehydrated ethanol R. Place a few drops of the mixture on a white porcelain dish and add 1 drop of vanillin/sulfuric acid TS1; a pink colour is produced.

Melting range. 81.0–84.0 °C.

Specific optical rotation. Use a 20 mg/ml solution in dehydrated ethanol R and calculate with reference to the dried substance; $[\alpha]_D^{20} = +155^\circ$ to $+157^\circ$.

Sulfated ash. Not more than 1.0 mg/g.

Loss on drying. Dry over phosphorus pentoxide R under reduced pressure (not exceeding 2.67 kPa or 20 mm of mercury); it loses not more than 5.0 mg/g.

Related substances

- *Either test A or test B may be applied.*
- A. Carry out the test as described under “High-performance liquid chromatography” (p. 257), using the conditions given below under Assay.

Inject alternately 20 μ l each of solutions A and C.

Measure the areas of the peak responses obtained in the chromatograms from solutions A and C, and calculate the content of the related substances as a percentage. In the chromatogram obtained with solution A, the area of any peak, other than the principal peak, is not greater than that obtained with solution C (0.5%). Not more than one peak is greater than half the area of the principal peak obtained with solution C (0.25%). The sum of the areas of all the peaks, other than the principal peak, is not greater than twice the area of the principal peak obtained with solution C (1.0%). Disregard any peak with an area less than 0.1 times the area of the principal peak in the chromatogram obtained with solution C.

- B. Carry out the test as described under “Thin-layer chromatography” (Vol. 1, p. 83), using silica gel R1 as the coating substance and a mixture of equal volumes of light petroleum R1 and ether R as the mobile phase. Apply separately to the plate 10 μ l of each of the following 5 solutions in toluene R containing (A) 10 mg of Artemotil per ml, (B) 0.05 mg of Artemotil per ml, (C) 0.025 mg of Artemotil per ml, (D) 0.10 mg of Artemotil per ml, and (E) 0.10 mg of artemotil RS per ml. After removing the plate from the chromatographic chamber, allow it to dry in air, and spray with vanillin/sulfuric acid TS1. Examine the chromatogram in daylight.

Any spot obtained with solution A, other than the principal spot, is not more intense than that obtained with solution B (0.5%). Furthermore, not more than one such spot is more intense than that obtained with solution C (0.25%).

Assay

Determine by “High-performance liquid chromatography” (p. 257), using a stainless steel column (25 cm \times 4 mm) packed with *stationary phase A* (5 μ m). As

the mobile phase, use a mixture of 62 volumes of acetonitrile R and 38 volumes of water.

Prepare the following solutions in the mobile phase: solution (A) 10 mg of Artemotil per ml; solution (B) 10 mg of artemotil RS per ml; and for solution (C) dilute solution A to obtain a concentration equivalent to 0.05 mg of Artemotil per ml.

Operate with a flow rate of 1.5 ml per minute. As a detector use an ultraviolet spectrophotometer set at a wavelength of about 216 nm.

Inject alternately 20 µl each of solutions A and B.

Measure the areas of the peak responses obtained in the chromatograms from solutions A and B, and calculate the percentage content of C₁₇H₂₈O₅ with reference to the dried substance.

Additional requirement for Artemotil for parenteral use

Complies with the monographs for "Parenteral preparations" (see Vol. 4, p. 36), "Test for extractable volume for parenteral preparations" (see p. 27), and "Visual inspection of particulate matter in injectable preparations" (see p. 33).

Artemotili injectio

Artemotil injection

Composition. Artemotil injection is a sterile solution of artemotil in an oil suitable for injection.

Description. A clear, colourless to slightly yellowish, oily solution.

Category. Antimalarial drug.

Storage. Artemotil injection should be kept protected from light.

Labelling. The oil used in the formulation should be indicated.

Additional information. Available strengths: 50 mg/ml (paediatric formulation), 75 mg/ml, 150 mg/ml (adult formulation).

Artemotil injection is normally intended for intramuscular administration. The solution is sterilized by a suitable method (see "Methods of sterilization", Vol. 4, p. 18).

Requirements

Complies with the monographs for "Parenteral preparations" (see Vol. 4, p. 36), "Test for extractable volume for parenteral preparations" (see p. 27), "Test for bacterial endotoxins" (see p. 30), and "Visual inspection of particulate matter in injectable preparations" (see p. 33).

Artemotil injection contains not less than **95.0%** and not more than **105.0%** of the amount of $C_{17}H_{28}O_5$ stated on the label.

Identity tests

- *Either tests A and B or tests B and C may be applied.*
- A. To a volume of the injection equivalent to 0.050 g of Artemotil add 25 ml of acetone R, mix, and filter. Evaporate the filtrate at low temperature and dry overnight over desiccant silica gel R. Carry out the examination as described under "Spectrophotometry in the infrared region" (Vol. 1, p. 40). The infrared absorption spectrum is concordant with the spectrum obtained from artemotil RS or with the *reference spectrum* of artemotil.
- B. See the test described below under "Related substances test B". The principal spot obtained with solution D corresponds in position, appearance, and intensity with that obtained with solution E.
- C. To a volume of the injection equivalent to about 30 mg of Artemotil add 6 ml of dehydrated ethanol R. Place a few drops of the mixture on a white porcelain dish and add 1 drop of vanillin/sulfuric acid TS1; a pink colour is produced.

Related substances

- *Either test A or test B may be applied.*
- A. Carry out the test as described under "High-performance liquid chromatography" (p. 257), using the conditions given below under Assay.

Inject alternately 20 μ l each of solutions A and C.

Measure the areas of the peak responses obtained in the chromatograms from solutions A and C, and calculate the content of the related substances as a percentage. In the chromatogram obtained with solution A, the area of any peak, other than the principal peak, is not greater than that obtained with solution C (0.5%). Not more than one peak is greater than half the area of the principal peak obtained with solution C (0.25%). The sum of the areas of all the peaks, other than the principal peak, is not greater than twice the area of the principal peak obtained with solution C (1.0%). Dis-

regard any peak with an area less than 0.1 times the area of the principal peak in the chromatogram obtained with solution C.

- B. Carry out the test as described under “Thin-layer chromatography” (Vol. 1, p. 83), using silica gel R1 as the coating substance and a mixture of equal volumes of light petroleum R1 and ether R as the mobile phase. Apply separately to the plate 10 µl of each of the following 5 solutions in toluene R. For solution (A) dilute a volume of the injection with toluene R to obtain a concentration equivalent to 10 mg of Artemotil per ml. Prepare similarly solution (B) with the equivalent of about 0.05 mg of Artemotil per ml, solution (C) with the equivalent of about 0.025 mg of Artemotil per ml, and solution (D) with the equivalent of 0.10 mg of Artemotil per ml. For solution (E) use 0.10 mg of artemotil RS per ml. After removing the plate from the chromatographic chamber, allow it to dry in air, and spray with vanillin/sulfuric acid TS1. Examine the chromatogram in daylight.

Any spot obtained with solution A, other than the principal spot, is not more intense than that obtained with solution B (0.5%). Furthermore, not more than one such spot is more intense than that obtained with solution C (0.25%).

Assay. Determine by “High-performance liquid chromatography” (p. 257), using a stainless steel column (25 cm × 4 mm) packed with *stationary phase A* (5 µm). As the mobile phase, use a mixture of 62 volumes of acetonitrile R and 38 volumes of water.

Prepare the following solutions in the mobile phase. For solution (A) dilute a volume of the injection to obtain a concentration equivalent to 10 mg of Artemotil per ml; for solution (B) use 10 mg of artemotil RS per ml; and for solution (C) dilute a suitable volume of solution A to obtain a concentration equivalent to 0.05 mg of Artemotil per ml.

Operate with a flow rate of 1.5 ml per minute. As a detector use an ultraviolet spectrophotometer set at a wavelength of about 216 nm.

Inject alternately 20 µl each of solutions A and B.

Measure the areas of the peak responses obtained in the chromatograms from solutions A and B, and calculate the percentage content of C₁₇H₂₈O₅.

Artenimolum

Artenimol

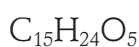
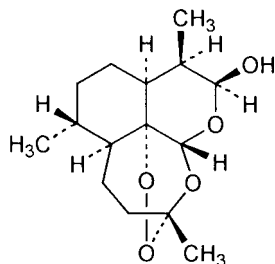

Relative molecular mass. 284.4

Chemical name. (3*R*,5*aS*,6*R*,8*aS*,9*R*,10*S*,12*R*,12*aR*)-Decahydro-3,6,9-trimethyl-3,12-epoxy-12*H*-pyrano[4,3-*j*]-1,2-benzodioxepin-10-ol; CAS Reg. No. 81496-81-3.

Other names. Dihydroartemisinin, β-dihydroartemisinin.

Description. Colourless needles or a white or almost white, crystalline powder.

Solubility. Practically insoluble in water; slightly soluble in acetonitrile R, ethanol (~750 g/l) TS and dichloromethane R.

Category. Antimalarial drug.

Storage. Artenimol should be kept in a well-closed container, protected from light.

Additional information. Melting temperature, about 137 °C, with decomposition.

Requirements

Artenimol contains not less than **97.0%** and not more than the equivalent of **102.0%** of C₁₅H₂₄O₅ using Assay method A, and not less than **98.0%** and not more than the equivalent of **102.0%** of C₁₅H₂₄O₅ using Assay method B, both calculated with reference to the dried substance.

Identity tests

- Either test A alone or tests B, C, and D may be applied.

- A. Carry out the examination as described under “Spectrophotometry in the infrared region” (Vol. 1, p. 40). The infrared absorption spectrum is concordant with the spectrum obtained from artemimol RS or with the *reference spectrum* of artemimol.
- B. See the test described below under “Related substances test B”. The principal spot obtained with solution D corresponds in position, appearance, and intensity with that obtained with solution E.
- C. Dissolve 5 mg in about 0.5 ml of dehydrated ethanol R, add about 0.5 ml of hydroxylamine hydrochloride TS2 and 0.25 ml of sodium hydroxide (~80 g/l) TS. Heat the mixture in a water-bath to boiling, cool, add 2 drops of hydrochloric acid (~70 g/l) TS and 2 drops of ferric chloride (50 g/l) TS; a deep violet colour is immediately produced.
- D. Dissolve 5 mg in about 0.5 ml of dehydrated ethanol R, add 1.0 ml of potassium iodide (80 g/l) TS, 2.5 ml of sulfuric acid (~100 g/l) TS, and 4 drops of starch TS; a violet colour is immediately produced.

Sulfated ash. Not more than 1.0 mg/g.

Loss on drying. Dry over phosphorus pentoxide R under reduced pressure (not exceeding 2.67 kPa or 20 mm of mercury); it loses not more than 10.0 mg/g.

Related substances

- *Either test A or test B may be applied.*

Note: Prepare fresh solutions and perform the tests without delay.

- A. Carry out the test as described under “High-performance liquid chromatography” (p. 257), using a stainless steel column (10 cm × 4.6 mm) packed with *stationary phase A* (3 µm). As the mobile phase for gradient elution, use a mixture of 6 volumes of acetonitrile R and 4 volumes of water for the first 17 minutes; then run a gradient, which should reach 100% acetonitrile within 13 minutes.

Prepare the following solutions. For solution (A) use 10 mg of Artemimol per ml in a mixture of 8 volumes of acetonitrile R and 2 volumes of water, and for solution (B) use 50 µg of Artemimol per ml in a mixture of 6 volumes of acetonitrile R and 4 volumes of water.

For the system suitability test prepare solution (C) containing 1.0 mg of artemisinin RS per ml and 1.0 mg of artemimol RS per ml in a mixture of 8 volumes of acetonitrile R and 2 volumes of water.

Operate with a flow rate of 0.6 ml per minute. As a detector use an ultraviolet spectrophotometer set at a wavelength of about 216 nm.

Inject alternately 20 μ l each of solutions A, B, and C.

The test is not valid unless the relative retention of α -artemimol compared with artemisinin is about 0.6, and the resolution between the peaks is not less than 2.0.

Measure the areas of the peak (twin-peak) responses obtained in the chromatograms from solutions A and B, and calculate the content of the related substances as a percentage. In the chromatogram obtained with solution A, the area of any peak, other than the twin peak, is not greater than that obtained with solution B (0.5%). Not more than one peak is greater than half the area of the twin peak obtained with solution B (0.25%). The sum of the areas of all the peaks, other than the twin peak, is not greater than twice the area of the twin peak obtained with solution B (1.0%). Disregard any peak with an area less than 0.1 times the area of the twin peak in the chromatogram obtained with solution B.

- B. Carry out the test as described under “Thin-layer chromatography” (Vol. 1, p. 83), using silica gel R1 as the coating substance and a mixture of equal volumes of light petroleum R1 and ether R as the mobile phase. Apply separately to the plate 10 μ l of each of the following 5 solutions in toluene R containing (A) 10 mg of Artemimol per ml, (B) 0.05 mg of Artemimol per ml, (C) 0.025 mg of Artemimol per ml, (D) 0.10 mg of Artemimol per ml, and (E) 0.10 mg of artemimol RS per ml. After removing the plate from the chromatographic chamber, allow it to dry in air, and spray with vanillin/sulfuric acid TS1. Examine the chromatogram in daylight.

Any spot obtained with solution A, other than the principal spot, is not more intense than that obtained with solution B (0.5%). Furthermore, not more than one such spot is more intense than that obtained with solution C (0.25%).

Assay

- *Either method A or method B may be applied.*

Note: Prepare fresh solutions and perform the tests without delay.

- A. Determine by “High-performance liquid chromatography” (p. 257), using a stainless steel column (10 cm \times 4.6 mm) packed with *stationary phase A* (3 μ m). As the mobile phase, use a mixture of 6 volumes of acetonitrile R and 4 volumes of water.

Prepare the following solutions in the mobile phase: solution (A) 1.0 mg of Artemimol per ml, and solution (B) 1.0 mg of artemimol RS per ml.

For the system suitability test prepare solution (C) containing 1.0 mg of artemisinin RS per ml and 1.0 mg of artemimol RS per ml in a mixture of 8 volumes of acetonitrile R and 2 volumes of water.

Operate with a flow rate of 0.6 ml per minute. As a detector use an ultra-violet spectrophotometer set at a wavelength of about 216 nm.

Inject alternately 20 µl each of solutions A, B, and C.

The test is not valid unless the relative retention of α-arternimol compared with artemisinin is about 0.6, and the resolution between the peaks is not less than 2.0.

Measure the areas of the peak (twin-peak) responses obtained in the chromatograms from solutions A and B, and calculate the percentage content of C₁₅H₂₂O₅ with reference to the dried substance.

- B. Dissolve about 0.05 g of Artemimol, accurately weighed, in sufficient ethanol (~750 g/l) TS to produce 100 ml and dilute 10 ml to 100 ml with the same solvent. Accurately transfer 10 ml to a 50-ml volumetric flask, dilute to volume with sodium hydroxide (0.05 mol/l) VS, mix thoroughly, and warm to 50 °C in a water-bath for 30 minutes. Cool to room temperature.

Measure the absorbance of a 1-cm layer at the maximum at about 292 nm against a solvent cell containing a blank prepared with 10 ml of ethanol (~750 g/l) TS diluted with sufficient sodium hydroxide (0.05 mol/l) VS to produce 50 ml. Calculate the percentage content of C₁₅H₂₂O₅ in the substance being tested by comparison with artemimol RS, similarly and concurrently examined, and with reference to the dried substance.

Artemimoli compressi

Artemimol tablets

Category. Antimalarial drug.

Storage. Artemimol tablets should be kept in a cool place and protected from light.

Additional information. Available strength: 20 mg.

Requirements

Complies with the monograph for "Tablets" (see Vol. 4, p. 26).

Arteminol tablets contain not less than **90.0%** and not more than **110.0%** of the amount of $C_{15}H_{24}O_5$ stated on the label.

Identity tests

- *Either test A alone or tests B, C, and D may be applied.*
- A. To a quantity of the powdered tablets equivalent to 0.040 g of Arteminol add 40 ml of acetone R, shake to dissolve, and filter. Evaporate the filtrate at low temperature and dry overnight over desiccant silica gel R. Carry out the examination with the residue as described under "Spectrophotometry in the infrared region" (Vol. 1, p. 40). The infrared absorption spectrum is concordant with the spectrum obtained from arteminol RS or with the *reference spectrum* of arteminol.
- B. See the test described below under "Related substances test B". The principal spot obtained with solution D corresponds in position, appearance, and intensity with that obtained with solution E.
- C. To a quantity of the powdered tablets equivalent to 10 mg of Arteminol add 20 ml of dehydrated ethanol R, shake to dissolve, filter, and evaporate to dryness. To half of the residue (keep the remaining residue for test D) add 0.5 ml of dehydrated ethanol R, 1.0 ml of potassium iodide (80 g/l) TS, 2.5 ml of sulfuric acid (~100 g/l) TS, and 4 drops of starch TS; a violet colour is immediately produced.
- D. Evaporate the remaining filtrate from test C to dryness on a water-bath. Dissolve the residue in 0.5 ml of dehydrated ethanol R, add about 0.5 ml of hydroxylamine hydrochloride TS2 and 0.25 ml of sodium hydroxide (~80 g/l) TS. Heat the mixture in a water-bath to boiling, cool, add 2 drops of hydrochloric acid (~70 g/l) TS and 2 drops of ferric chloride (50 g/l) TS; a deep violet colour is immediately produced.

Related substances

- *Either test A or test B may be applied.*

Note: Prepare fresh solutions and perform the tests without delay.

- A. Carry out the test as described under "High-performance liquid chromatography" (p. 257), using a stainless steel column (10 cm × 4.6 mm) packed with *stationary phase A* (3 μm). As the mobile phase for gradient elution, use a mixture of 6 volumes of acetonitrile R and 4 volumes of

water for the first 17 minutes; then run a gradient, which should reach 100% acetonitrile within 13 minutes.

Prepare the following solutions. For solution (A) weigh and powder 20 tablets, shake a quantity of the powder equivalent to about 10 mg of Artemimol, accurately weighed, with 2 ml of acetone R, and filter. Evaporate the filtrate to dryness and dissolve the residue in 1.0 ml of a mixture of 8 volumes of acetonitrile R and 2 volumes of water. For solution (B) use 50 µg of Artemimol per ml in a mixture of 6 volumes of acetonitrile R and 4 volumes of water.

For the system suitability test prepare solution (C) containing 1.0 mg of artemisinin RS per ml and 1.0 mg of artemimol RS per ml in a mixture of 8 volumes of acetonitrile R and 2 volumes of water.

Operate with a flow rate of 0.6 ml per minute. As a detector use an ultraviolet spectrophotometer set at a wavelength of about 216 nm.

Inject alternately 20 µl each of solutions A, B, and C.

The test is not valid unless the relative retention of α -artemimol compared with artemisinin is about 0.6, and the resolution between the peaks is not less than 2.0.

Measure the areas of the peak (twin-peak) responses obtained in the chromatograms from solutions A and B, and calculate the content of the related substances as a percentage. In the chromatogram obtained with solution A, the area of any peak, other than the twin peak, is not greater than that obtained with solution B (0.5%). Not more than one peak is greater than half the area of the twin peak obtained with solution B (0.25%). The sum of the areas of all the peaks, other than the twin peak, is not greater than twice the area of the twin peak obtained with solution B (1.0%). Disregard any peak with an area less than 0.1 times the area of the twin peak in the chromatogram obtained with solution B.

- B. Carry out the test as described under "Thin-layer chromatography" (Vol. 1, p. 83), using silica gel R1 as the coating substance and a mixture of equal volumes of light petroleum R1 and ether R as the mobile phase. Apply separately to the plate 10 µl of each of the following 5 solutions in toluene R. For solution (A) shake a quantity of the powdered tablets equivalent to about 20 mg of Artemimol, with 2 ml of acetone R, and filter. Use the filtrate. Prepare similarly solution (B) with the equivalent of about 0.05 mg of Artemimol per ml, solution (C) with the equivalent of about 0.025 mg of Artemimol per ml, and solution (D) with the equivalent of about 0.10 mg of Artemimol per ml. For solution (E) use 0.10 mg of artemimol RS per ml. After removing the plate from the chromatographic chamber, allow it to

dry in air, and spray with vanillin/sulfuric acid TS1. Examine the chromatogram in daylight.

Any spot obtained with solution A, other than the principal spot, is not more intense than that obtained with solution B (0.5%). Furthermore, not more than one such spot is more intense than that obtained with solution C (0.25%).

Assay

- *Either method A or method B may be applied.*

Note: Prepare fresh solutions and perform the tests without delay.

- A. Determine by “High-performance liquid chromatography” (p. 257), using a stainless steel column (10 cm × 4.6 mm) packed with *stationary phase A* (3 μm). As the mobile phase, use a mixture of 6 volumes of acetonitrile R and 4 volumes of water.

Prepare the following solutions in the mobile phase. For solution (A) weigh and powder 20 tablets, shake a quantity of the powder equivalent to about 1.0 mg of Arteminol, accurately weighed, with 2 ml of acetone R, and filter. Evaporate the filtrate to dryness, and dissolve the residue in 1.0 ml. For solution (B) use 1.0 mg of arteminol RS per ml.

For the system suitability test prepare solution (C) containing 1.0 mg of artemisinin RS per ml and 1.0 mg of arteminol RS per ml in a mixture of 8 volumes of acetonitrile R and 2 volumes of water.

Operate with a flow rate of 0.6 ml per minute. As a detector use an ultraviolet spectrophotometer set at a wavelength of about 216 nm.

Inject alternately 20 μl each of solutions A, B, and C.

The test is not valid unless the relative retention of α-artemimol compared with artemisinin is about 0.6, and the resolution between the peaks is not less than 2.0.

Measure the areas of the peak (twin-peak) responses obtained in the chromatograms from solutions A and B, and calculate the percentage content of C₁₅H₂₄O₅.

- B. Weigh and powder 20 tablets. To a quantity of the powder equivalent to about 0.05 g of Arteminol, accurately weighed, add sufficient ethanol (~750 g/l) TS to produce 100 ml, shake, and filter. Discard the initial 20 ml of the filtrate and dilute 10 ml to 100 ml with the same solvent. Accurately transfer 10 ml to a 50-ml volumetric flask, dilute to volume with sodium

hydroxide (0.05 mol/l) VS, mix thoroughly, and warm to 50 °C in a water-bath for 30 minutes. Cool to room temperature.

Measure the absorbance of a 1-cm layer at the maximum at about 292 nm against a solvent cell containing a blank prepared with 10 ml of ethanol (~750 g/l) TS diluted with sufficient sodium hydroxide (0.05 mol/l) VS to produce 50 ml. Calculate the percentage content of C₁₅H₂₄O₅ in the substance being tested by comparison with arteminol RS, similarly and concurrently examined.

Dissolution test. (See Preface, p. ix.)

Artesunatum

Artesunate

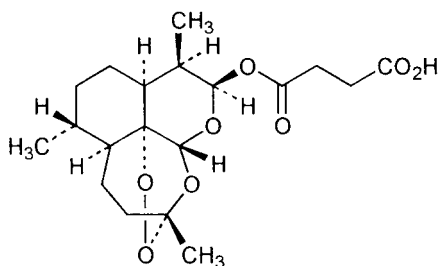

Relative molecular mass. 384.4

Chemical name. (3*R*,5*aS*,6*R*,8*aS*,9*R*,10*S*,12*R*,12*aR*)-Decahydro-3,6,9-trimethyl-3,12-epoxy-12*H*-pyrano[4,3-*j*]-1,2-benzodioxepin-10-ol, hydrogen succinate; CAS Reg. No. 88495-63-0.

Description. A fine, white crystalline powder.

Solubility. Very slightly soluble in water; very soluble in dichloromethane R; freely soluble in ethanol (~750 g/l) TS and acetone R.

Category. Antimalarial drug.

Storage. Artesunate should be kept in a well-closed container, protected from light and stored in a cool place.

Requirements

Artesunate contains not less than **96.0%** and not more than the equivalent of **102.0%** of $C_{19}H_{28}O_8$ using Assay method A, and not less than **99.0%** and not more than the equivalent of **101.0%** of $C_{19}H_{28}O_8$ using Assay method B, both calculated with reference to the anhydrous substance.

Identity tests

- *Either test A alone or tests B, C, and D may be applied.*
- A. Carry out the examination as described under "Spectrophotometry in the infrared region" (Vol. 1, p. 40). The infrared absorption spectrum is concordant with the spectrum obtained from artesunate RS or with the *reference spectrum* of artesunate.
- B. Carry out the test as described under "Thin-layer chromatography" (Vol. 1, p. 83), using silica gel R6 as the coating substance and a mixture of 5 volumes of ethyl acetate R and 95 volumes of toluene R as the mobile phase. Apply separately to the plate 2 μ l of the following 2 solutions in toluene R containing (A) 0.10 mg of Artesunate per ml, and (B) 0.10 mg of artesunate RS per ml. After removing the plate from the chromatographic chamber, allow it to dry in air, spray with anisaldehyde/methanol TS, and heat the plate to 120 °C for 5 minutes. Examine the chromatogram in ultraviolet light (254 nm).

The principal spot obtained with solution A corresponds in position, appearance, and intensity with that obtained with solution B.

- C. Dissolve 0.1 g of Artesunate in 40 ml of dehydrated ethanol R, shake, and filter. To half of the filtrate (keep the remaining filtrate for test D) add about 0.5 ml of hydroxylamine hydrochloride TS2 and 0.25 ml of sodium hydroxide (~80 g/l) TS. Heat the mixture in a water-bath to boiling, cool, add 2 drops of hydrochloric acid (~70 g/l) TS and 2 drops of ferric chloride (50 g/l) TS; a light red-violet colour is produced.
- D. Evaporate the remaining filtrate from test C on a water-bath to a volume of about 5 ml. Place a few drops of the mixture on a white porcelain dish, add 1 drop of vanillin/sulfuric acid TS2, and allow to stand for 30 minutes; a red colour is produced.

Melting range. 132–135 °C.

Specific optical rotation. Use a 10 mg/ml solution in dichloromethane R; $[\alpha]_D^{20} = +2.5^\circ$ to $+3.5^\circ$.

Heavy metals. Use 1.0 g for the preparation of the test solution as described under “Limit test for heavy metals”, Procedure 3 (Vol. 1, p. 118); determine the heavy metals content according to Method A (Vol. 1, p. 119); not more than 20 µg/g.

Sulfated ash. Not more than 1.0 mg/g.

Water. Determine as described under “Determination of water by the Karl Fischer Method”, Method A (Vol. 1, p. 135), using 2 g of Artesunate; the water content is not more than 5 mg/g.

pH value. pH of an aqueous suspension containing 10 mg/g, 3.5–4.5.

Related substances

- *Either test A or test B may be applied.*

A. Carry out the test as described under “High-performance liquid chromatography” (p. 257), using the conditions given below under Assay method A.

Inject alternately 20 µl each of solutions A and C.

Measure the areas of the peak responses obtained in the chromatograms from solutions A and C, and calculate the content of the related substances as a percentage. In the chromatogram obtained with solution A, the area of any peak, other than the principal peak, is not greater than that obtained with solution C (1.0%). Not more than one peak is greater than half the area of the principal peak obtained with solution C (0.5%). The sum of the areas of all peaks, other than the principal peak, is not greater than twice the area of the principal peak obtained with solution C (2.0%). Disregard any peak with an area less than 0.1 times the area of the principal peak in the chromatogram obtained with solution C.

B. Carry out the test as described under “Thin-layer chromatography” (Vol. 1, p. 83), using silica gel R1 as the coating substance and a mixture of 48 volumes of light petroleum R1, 36 volumes of ethyl acetate R and 1 volume of glacial acetic acid R as the mobile phase. Apply separately to the plate 10 µl of each of the following 3 solutions in dichloromethane R containing (A) 5.0 mg of Artesunate per ml, (B) 0.05 mg of Artesunate per ml, and (C) 0.025 mg of Artesunate per ml. After removing the plate from the chromatographic chamber, allow it to dry in air, and spray with vanillin/sulfuric acid TS1. Examine the chromatogram in daylight.

Any spot obtained with solution A, other than the principal spot, is not more intense than that obtained with solution B (1.0%). Furthermore, not more than one such spot is more intense than that obtained with solution C (0.5%).

Assay

- Either method A or method B may be applied.

A. Determine by “High-performance liquid chromatography” (p. 257), using a stainless steel column (12.5 cm × 3.5 mm) packed with *stationary phase A* (5 μm). As the mobile phase, use a mixture of equal volumes of acetonitrile R and buffer pH 3.0 (dissolve 1.36 g of potassium dihydrogen phosphate R in 1000 ml of water and adjust the pH to 3.0 with phosphoric acid (~1440 g/l) TS).

Prepare the following solutions in acetonitrile R: solution (A) 4.0 mg of Artesunate per ml; solution (B) 4.0 mg of artesunate RS per ml; and for solution (C) dilute solution A to obtain a concentration equivalent to 0.04 mg of Artesunate per ml.

Operate with a flow rate of 0.6 ml per minute. Maintain the column temperature at 30 °C and use an ultraviolet spectrophotometer set at a wavelength of about 216 nm.

Inject alternately 20 μl each of solutions A and B.

Measure the areas of the peak responses obtained in the chromatograms from solutions A and B, and calculate the percentage content of C₁₉H₂₈O₈ with reference to the anhydrous substance.

B. Dissolve about 0.25 g of Artesunate, accurately weighed, in 25 ml of neutralized ethanol TS and titrate with sodium hydroxide (0.05 mol/l) VS, using 2 drops of phenolphthalein/ethanol TS as indicator.

Each ml of sodium hydroxide (0.05 mol/l) VS is equivalent to 19.22 mg of C₁₉H₂₈O₈.

Artesunati compressi

Artesunate tablets

Category. Antimalarial drug.

Storage. Artesunate tablets should be kept in a cool place.

Additional information. Strength in the current WHO Model list of essential drugs: 50 mg.

Requirements

Complies with the monograph for "Tablets" (see Vol. 4, p. 26).

Artesunate tablets contain not less than **90.0%** and not more than **110.0%** of the amount of $C_{19}H_{28}O_8$ stated on the label.

Identity tests

- *Either test A alone or tests B, C, and D may be applied.*
- A. To a quantity of the powdered tablets equivalent to 0.050 g of Artesunate add 25 ml of acetone R, shake to dissolve, and filter. Evaporate the filtrate at low temperature and dry overnight over desiccant silica gel R. Carry out the examination with the residue as described under "Spectrophotometry in the infrared region" (Vol. 1, p. 40). The infrared absorption spectrum is concordant with the spectrum obtained from artesunate RS or with the *reference spectrum* of artesunate.
- B. Carry out the test as described under "Thin-layer chromatography" (Vol. 1, p. 83), using silica gel R6 as the coating substance and a mixture of 5 volumes of ethyl acetate R and 95 volumes of toluene R as the mobile phase. Apply separately to the plate 2 μ l of the following 2 solutions in toluene R. For solution (A) shake a quantity of the powdered tablets equivalent to about 0.10 mg of Artesunate in dehydrated ethanol R, filter, and evaporate. Dissolve the residue in 1.0 ml of toluene R. For solution (B) use 0.10 mg of artesunate RS per ml. After removing the plate from the chromatographic chamber, allow it to dry in air, spray with anisaldehyde/methanol TS, and heat the plate to 120 °C for 5 minutes. Examine the chromatogram in ultraviolet light (254 nm).

The principal spot obtained with solution A corresponds in position, appearance, and intensity with that obtained with solution B.

- C. To a quantity of the powdered tablets equivalent to 0.1 g of Artesunate add 40 ml of dehydrated ethanol R, shake to dissolve, and filter. To half of the filtrate (keep the remaining filtrate for test D) add about 0.5 ml of hydroxylamine hydrochloride TS2 and 0.25 ml of sodium hydroxide (~80 g/l) TS. Heat the mixture in a water-bath to boiling, cool, add 2 drops of hydrochloric acid (~70 g/l) TS and 2 drops of ferric chloride (50 g/l) TS; a light red-violet colour is produced.
- D. Evaporate the remaining filtrate from test C on a water-bath to a volume of about 5 ml. Place a few drops of the mixture on a white porcelain dish, add 1 drop of vanillin/sulfuric acid TS2, and allow to stand for 30 minutes; a red colour is produced.

Related substances

- Either test A or test B may be applied.
- A. Carry out the test as described under “High-performance liquid chromatography” (p. 257), using the conditions given below under Assay method A.

Inject alternately 20 µl each of solutions A and C.

Measure the areas of the peak responses obtained in the chromatograms from solutions A and C, and calculate the content of the related substances as a percentage. In the chromatogram obtained with solution A, the area of any peak, other than the principal peak, is not greater than that obtained with solution C (1.0%). Not more than one peak is greater than half the area of the principal peak obtained with solution C (0.5%). The sum of the areas of all the peaks, other than the principal peak, is not greater than twice the area of the principal peak obtained with solution C (2.0%). Disregard any peak with an area less than 0.1 times the area of the principal peak in the chromatogram obtained with solution C.

- B. Carry out the test as described under “Thin-layer chromatography” (Vol. 1, p. 83), using silica gel R1 as the coating substance and a mixture of 48 volumes of light petroleum R1, 36 volumes of ethyl acetate R and 1 volume of glacial acetic acid R as the mobile phase. Apply separately to the plate 10 µl of each of the following 3 solutions in dichloromethane R. For solution (A) shake a quantity of the powdered tablets equivalent to about 10 mg of Artesunate with 2 ml of dichloromethane R, filter, and use the filtrate. Prepare similarly solution (B) with the equivalent of about 0.05 mg of Artesunate per ml, and solution (C) with the equivalent of about 0.025 mg of Artesunate per ml. After removing the plate from the chromatographic chamber, allow it to dry in air, and spray with vanillin/sulfuric acid TS1. Examine the chromatogram in daylight.

Any spot obtained with solution A, other than the principal spot, is not more intense than that obtained with solution B (1.0%). Furthermore, not more than one such spot is more intense than that obtained with solution C (0.5%).

Assay

- Either method A or method B may be applied.
- A. Determine by “High-performance liquid chromatography” (p. 257), using a stainless steel column (12.5 cm × 3.5 mm) packed with *stationary phase A* (5 µm). As the mobile phase, use a mixture of equal volumes of acetonitrile R and buffer pH 3.0 (dissolve 1.36 g of potassium dihydrogen phosphate R in 1000 ml of water and adjust the pH to 3.0 with phosphoric acid (~1440 g/l) TS).

Prepare the following solutions in acetonitrile R. For solution (A) weigh and powder 20 tablets, shake a quantity of the powder equivalent to about 4.0 mg of Artesunate, accurately weighed, with 2 ml of acetone R, and filter. Evaporate the filtrate to dryness, and dissolve the residue in 1.0 ml. For solution (B) use 4.0 mg of artesunate RS per ml, and for solution (C) dilute solution A to obtain a concentration equivalent to 0.04 mg of Artesunate per ml.

Operate with a flow rate of 0.6 ml per minute. Maintain the column temperature at 30°C and use an ultraviolet spectrophotometer set at a wavelength of about 216 nm.

Inject alternately 20 µl each of solutions A and B.

Measure the areas of the peak responses obtained in the chromatograms from solutions A and B, and calculate the percentage content of C₁₉H₂₈O₈.

- B. Weigh and powder 20 tablets. To a quantity of the powder equivalent to about 0.5 g of Artesunate, accurately weighed, add 50 ml of neutralized ethanol TS, shake thoroughly, filter, and discard about 10 ml of the initial filtrate. Titrate 25 ml of the filtrate with sodium hydroxide (0.05 mol/l) VS, using 2 drops of phenolphthalein/ethanol TS as indicator.

Each ml of sodium hydroxide (0.05 mol/l) VS is equivalent to 19.22 mg of C₁₉H₂₈O₈.

Dissolution test. (See Preface, p. vii.)

Mefloquini hydrochloridum

Mefloquine hydrochloride

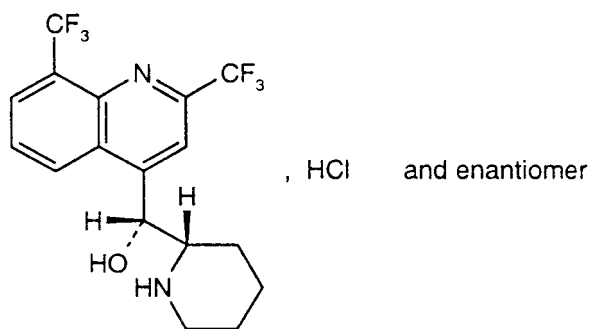

Relative molecular mass. 414.8

Chemical name. DL-erythro- α -2-piperidyl-2,8-bis(trifluoromethyl)-4-quinolinemethanol monohydrochloride; (R^*,S^*)-(\pm)- α -2-piperidiny-2,8-bis(trifluoromethyl)-4-quinolinemethanol monohydrochloride; CAS Reg. No. 51773-92-3.

Description. A white to slightly yellow, crystalline powder.

Solubility. Very slightly soluble in water; freely soluble in methanol R; soluble in ethanol (~750 g/l) TS; sparingly soluble in dichloromethane R.

Category. Antimalarial drug.

Storage. Mefloquine hydrochloride should be kept in a tightly closed container, protected from light.

Additional information. Mefloquine hydrochloride melts at about 260°C, with decomposition.

Requirements

Mefloquine hydrochloride contains not less than **99.0%** and not more than the equivalent of **101.0%** of $C_{17}H_{16}F_6N_2O, HCl$, calculated with reference to the anhydrous and solvent-free substance.

Identity tests

- *Either tests A and E or tests B, C, D, and E may be applied.*
- A. Carry out the examination as described under "Spectrophotometry in the infrared region" (Vol. 1, p. 40). The infrared absorption spectrum is concordant with the spectrum obtained from mefloquine hydrochloride RS or with the *reference spectrum* of mefloquine hydrochloride.
- B. See the test described below under "Related substances". The principal spot obtained with solution B corresponds in position, appearance, and intensity with that obtained with solution C.
- C. Transfer about 10 mg to a porcelain crucible, add 45 mg of magnesium oxide R, and ignite until an almost white residue is obtained. Allow to cool, add 2.0 ml of water, 0.05 ml of phenolphthalein/ethanol TS, and about 1 ml of hydrochloric acid (~70 g/l) TS. Filter, to the filtrate add a freshly prepared mixture of 0.10 ml of sodium alizarinsulfonate (1 g/l) TS and 0.10 ml of zirconyl nitrate TS, mix, and allow to stand for 5 minutes. Prepare similarly a reagent blank; a yellow colour is produced, whereas the reagent blank is red.

D. To 20 mg add about 0.2 ml of sulfuric acid (~1760 g/l) TS and view the mixture under ultraviolet light (365 nm); a blue fluorescence is observed.

E. A 0.05 g/ml solution yields reaction B described under “General identification tests” as characteristic of chlorides (Vol. 1, p. 112).

Heavy metals. Use 1.0 g for the preparation of the test solution as described under “Limit test for heavy metals”, Procedure 3 (Vol. 1, p. 118); determine the heavy metals content according to Method A (Vol. 1, p. 119); not more than 20 µg/g.

Solution in methanol. A solution of 0.50 g in 10 ml of methanol R is clear and not more intensely coloured than standard colour solution Yw1 when compared as described under “Colour of liquids” (Vol. 1, p. 50).

Sulfated ash. Not more than 1.0 mg/g.

Water. Determine as described under “Determination of water by the Karl Fischer method”, Method A (Vol. 1, p. 135), using 1.0 g of Mefloquine hydrochloride; the water content is not more than 30 mg/g.

Related substances. Carry out the test as described under “Thin-layer chromatography” (Vol. 1, p. 83), using silica gel R3 as the coating substance and a mixture of 8 volumes of dichloromethane R, 1 volume of glacial acetic acid R1, and 1 volume of methanol R as the mobile phase. Apply separately to the plate 5 µl of each of 4 solutions in methanol R containing (A) 8 mg of Mefloquine hydrochloride per ml, (B) 1.6 mg of Mefloquine hydrochloride per ml, (C) 1.6 mg of mefloquine hydrochloride RS per ml, and (D) 0.04 mg of mefloquine hydrochloride RS per ml. After removing the plate from the chromatographic chamber, allow it to dry in a current of warm air for 15 minutes, and spray with a freshly prepared mixture of 1 volume of sulfuric acid (~1760 g/l) TS and 40 volumes of potassium iodoplatinate TS. Then spray again with hydrogen peroxide (~330 g/l) TS and examine the chromatogram in daylight.

Any spot obtained with solution A, other than the principal spot, is not more intense than that obtained with solution D (0.5%).

Ethanol, methanol, and acetone. Carry out the test as described under “Gas chromatography” (Vol. 1, p. 94), using a stainless steel column (2 m × 2.2 mm) packed with graphitized carbon (135–175 µm) (this may be obtained from a commercial source) which is impregnated with a 0.05 g/ml solution of macrogol 20M R. Maintain the column at 70 °C, the injection port at 200 °C, and the detector at 250 °C. Use helium R as the carrier gas at a flow rate of 35 ml per minute, and a flame ionization detector.

Use the following two solutions: (1) dissolve 1.0 g of Mefloquine hydrochloride in 10 ml of dimethylformamide R, and (2) prepare a mixture of 1.0 g of methanol R, 1.0 g of dehydrated ethanol R, and 1.0 g of acetone R diluted to 100 ml with dimethylformamide R; further dilute 1.0 ml of this solution to 100 ml with dimethylformamide R.

Inject 1 µl each of solutions 1 and 2.

Measure the areas of the peak responses obtained in the chromatograms from solutions 1 and 2, and calculate the total content of ethanol, methanol, and acetone; the total content does not exceed 5 mg/g.

Assay. Dissolve about 0.31 g, accurately weighed, in 70 ml of glacial acetic acid R1, add 5 ml of mercuric acetate/acetic acid TS, and titrate with perchloric acid (0.1 mol/l) VS as described under “Non-aqueous titration”, Method A (Vol. 1, p. 131).

Each ml of perchloric acid (0.1 mol/l) VS is equivalent to 41.48 mg of $C_{17}H_{16}F_6N_2O, HCl$.

Proguanili hydrochloridum

Proguanil hydrochloride

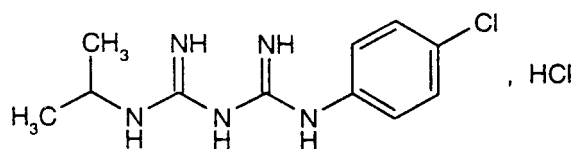

$C_{11}H_{16}ClN_5, HCl$

Relative molecular mass. 290.2

Chemical name. 1-(*p*-Chlorophenyl)-5-isopropylbiguanide hydrochloride; CAS Reg. No. 637-32-1.

Description. A white, crystalline powder.

Solubility. Slightly soluble in water, more soluble in hot water; sparingly soluble in ethanol (~750 g/l) TS.

Category. Antimalarial drug.

Storage. Proguanil hydrochloride should be kept in a well-closed container, protected from light.

Requirements

Proguanil hydrochloride contains not less than **99.0%** and not more than **101.0%** of $C_{11}H_{16}ClN_5$, HCl, calculated with reference to the dried substance.

Identity tests

- *Either tests A and D or tests B, C, and D may be applied.*
- A. Carry out the examination as described under “Spectrophotometry in the infrared region” (Vol. 1, p. 40). The infrared absorption spectrum is concordant with the spectrum obtained from proguanil hydrochloride RS or with the *reference spectrum* of proguanil hydrochloride.
- B. Dissolve about 0.1 g in 10 ml of water, add 5 drops of potassium ferrocyanide (45 g/l) TS; a white precipitate is produced. Add 10–15 drops of nitric acid (~130 g/l) TS; the precipitate dissolves.
- C. Dissolve about 0.1 g in 10 ml of water, add 3 drops of copper(II) sulfate (160 g/l) TS and 1.0 ml of ammonia (~100 g/l) TS, shake, add 5 ml of toluene R, and shake again; a violet colour is produced in the toluene layer.
- D. A 20 mg/ml solution yields reaction A described under “General identification tests” as characteristic of chlorides (Vol. 1, p. 112).

Sulfated ash. Not more than 1.0 mg/g

Loss on drying. Dry to constant mass at 105°C; it loses not more than 5.0 mg/g.

Acidity or alkalinity. To 35 ml of water maintained at a temperature of about 65°C add 0.20 ml of methyl red/methylthionium chloride TS, neutralize with sodium hydroxide (0.01 mol/l) VS or hydrochloric acid (0.01 mol/l) VS, add 0.4 g of Proguanil hydrochloride, and stir until dissolved; the resulting solution is not acidic and requires for neutralization not more than 0.2 ml of hydrochloric acid (0.01 mol/l) VS.

Chloraniline. For solution A, dissolve 0.10 g in 1 ml of hydrochloric acid (~70 g/l) TS, and add sufficient water to produce 20 ml. Cool to 5°C, add 1 ml of sodium nitrite (35 g/l) TS, allow to stand at 5°C for 5 minutes, add 2 ml of ammonium sulfamate (50 g/l) TS, shake, and allow to stand for 10 minutes. Add 2 ml of freshly prepared *N*-(1-naphthyl)ethylenediamine hydrochloride (1 g/l) TS, dilute to 50 ml with water, and allow to stand for 30 minutes. For solution

B, treat similarly 20 ml of a solution containing 1.25 µg of chloraniline R per ml. Any magenta colour produced in solution A is not more intense than that produced in solution B (250 µg/g).

Related substances. Carry out the test as described under “High-performance liquid chromatography” (p. 257), using a stainless steel column (10 cm × 5.0 mm) packed with *stationary phase A* (5 µm). As the mobile phase, use a solution prepared as follows: dissolve 1.88 g of sodium hexanesulfonate R in 1000 ml of a mixture of 12 volumes of methanol R, 8 volumes of water, and 0.1 volume of glacial acetic acid R.

Prepare the following solutions in the mobile phase: solution (A) 1.0 µg of Proguanil hydrochloride per ml; and solution (B) 0.10 mg of Proguanil hydrochloride per ml.

Operate with a flow rate of 1.0 ml per minute. As a detector use an ultraviolet spectrophotometer set at a wavelength of about 254 nm.

Inject alternately 10 µl each of solutions A and B.

Measure the areas of the peak responses obtained in the chromatograms from solutions A and B, and calculate the content of the related substances as a percentage. The sum of the areas of any peaks, other than the principal peak, in the chromatogram obtained from solution B is not greater than that of the principal peak obtained with solution A (1%).

Assay. Dissolve about 0.3 g, accurately weighed, in 30 ml of glacial acetic acid R1, add 10 ml of mercuric acetate/acetic acid TS, and titrate with perchloric acid (0.1 mol/l) VS as described under “Non-aqueous titration”, Method A (Vol. 1, p. 131), determining the end-point potentiometrically.

Each ml of perchloric acid (0.1 mol/l) VS is equivalent to 14.51 mg of $C_{11}H_{16}ClN_5, HCl$.

List of reagents, test solutions, and
volumetric solutions

List of reagents, test solutions, and volumetric solutions

Attention is drawn to the notes at the head of the "List of reagents, test solutions, and volumetric solutions" published in Volume 2. These contain explanations of the various abbreviations used.

International Chemical Reference Substances are available from the WHO Collaborating Centre for Chemical Reference Substances, Apoteket AB, Produktion & Laboratorier Centrallaboratoriet, ACL, Prismavägen 2, S-141 75 Kungens Kurva, Sweden. (Fax: +46 8 740 60 40; email:who.apl@apoteket.se)

Acetaldehyde R. Ethanal; C_2H_4O .

Description. A clear, colourless, flammable liquid.

Miscibility. Miscible with water and ethanol (~750 g/l) TS.

Refractive index. $n_D^{20} = 1.332$.

Relative density. $d_{20}^{20} = 0.788$.

Boiling point. About 21 °C.

Albendazole RS. International Chemical Reference Substance.

Alcuronium chloride RS. International Chemical Reference Substance.

Aluminium oxide R. Al_2O_3 .

A suitable grade for use in thin-layer chromatography.

7-[(2-Aminoethyl)amino]-1-cyclopropyl-6-fluoro-1,4-dihydro-4-oxoquinoline-3-carboxylic acid RS (ciprofloxacin ethylenediamine compound). International Chemical Reference Substance.

Ammonium acetate TS

Procedure. Dissolve 150 g of ammonium acetate R in water, add 3 ml of glacial acetic acid R, and dilute with sufficient water to produce 1000 ml.

Note: Ammonium acetate TS must be used within 1 week of preparation.

Ammonium acetate (50 g/l) TS. A solution of ammonium acetate R containing about 50 g of $C_2H_7NO_2$ per litre.

Ammonium chloride (20 g/l) TS. A solution of ammonium chloride R containing about 20 g of NH_4Cl per litre.

Ammonium nitrate TS

Procedure. Dissolve 1.6 g of ammonium nitrate R in 30 ml of water, add 3.0 ml of ammonia (~260 g/l) TS, and dilute with sufficient water to produce 100 ml.

Ammonium thiocyanate (10 g/l) TS. A solution of ammonium thiocyanate R containing 10 g of NH_4SCN per litre.

Amoxicillin trihydrate RS. International Chemical Reference Substance.

Anisaldehyde R. 4-Methoxybenzaldehyde; $C_8H_8O_2$.

Description. A colourless to pale yellow, oily liquid.

Solubility. Very slightly soluble in water, miscible with ethanol (~750 g/l) TS and ether R.

Mass density. ρ_{20} = about 1.125 kg/l.

Boiling point. About 248 °C.

Anisaldehyde TS

Procedure. Mix in the following order 0.5 ml of anisaldehyde R, 10 ml of glacial acetic acid R, 85 ml of methanol R, and 5 ml of sulfuric acid (~1760 g/l) TS.

Anisaldehyde/methanol TS

Procedure. Slowly add 10 ml of glacial acetic acid R and 5 ml of sulfuric acid (~1760 g/l) TS to 55 ml of methanol R, and cool to room temperature. Separately add 0.5 ml of anisaldehyde R to 30 ml of methanol R. Mix the two solutions thoroughly.

Storage. Keep anisaldehyde/methanol TS protected from light.

Note: Anisaldehyde/methanol TS should be freshly prepared.

Anisaldehyde/sulfuric acid TS

Procedure. Add 5 ml of anisaldehyde R to 10 ml of sulfuric acid (~1760 g/l) TS.

Anthrone TS2

Procedure. Dissolve 200 mg of anthrone R in 100 ml of sulfuric acid (~1760 g/l) TS.

Aprotinin R. A polypeptide consisting of a chain of 58 amino acids.

A commercially available reagent of suitable grade.

Argon R. Ar. Contains not less than 99.995% of Ar.

Carbon monoxide. When used as described in the test for carbon monoxide in medicinal gases, after passage of 10 litres of argon at a flow rate of 4 litres per hour, not more than 0.05 ml of sodium thiosulfate (0.002 mol/l) VS is required for the titration (0.6 μ l/l).

Artemether RS. International Chemical Reference Substance.

Artemisinin RS. International Chemical Reference Substance.

Artemotil RS. International Chemical Reference Substance.

Artenimol RS. International Chemical Reference Substance.

Artesunate RS. International Chemical Reference Substance.

Atenolol RS. International Chemical Reference Substance.

Atenolol for column validation RS. International Chemical Reference Substance.

Barium hydroxide (0.15 mol/l) VS. Barium hydroxide R dissolved in carbon-dioxide-free water R to contain 25.7 g of Ba(OH)₂ in 1000 ml.

Benznidazole RS. International Chemical Reference Substance.

Benzophenone R. Diphenyl ketone; C₁₃H₁₀O.
A commercially available reagent of suitable grade.
Melting point. About 49 °C.

Benzoyl peroxide, hydrous R. C₁₄H₁₀O₄·xH₂O.
A commercially available reagent of suitable grade.
Description. A white, amorphous or granular powder.
Note: For safety reasons it should be kept moistened with about 23% w/w water.

Benzyl benzoate R. C₁₄H₁₂O₂.
Benzyl benzoate as described in the monograph in Vol. 2 (p. 46).
A commercially available reagent of suitable grade.
Description. A clear, colourless, oily liquid.

9,9'-Bisanthracene-10,10'(9H,9'H)-dione RS. International Chemical Reference Substance.

4,4'-Bis(dimethylamino)benzophenone R. Tetramethyldiaminobenzophenone; C₁₇H₂₀N₂O.
Other name. Michler's ketone.
Melting point. About 176 °C.

Bromophenol blue (1 g/l) TS. A solution of bromophenol blue R containing about 1.0 g of C₁₉H₁₀Br₄O₅S per litre.

Butylated hydroxyanisole R. Use C₁₁H₁₆O₂.
Butylated hydroxyanisole as described in the monograph in Vol. 4 (p. 140).

tert-Butyl methyl ether R. 1,1-Dimethylethyl methyl ether; C₅H₁₂O.
A commercially available reagent of suitable grade.
Description. A clear, colourless liquid; inflammable.
Refractive index. $n_D^{20} = 1.3756$.
Relative density. $d_4^{20} = 0.740-0.742$.

Caesium chloride R. CsCl.
A commercially available reagent of suitable grade.

Calcium chloride (3.7 g/l) TS. A solution of anhydrous calcium chloride R containing about 9 g of CaCl₂ per litre.

Captopril RS. International Chemical Reference Substance.

Captopril disulfide RS. International Chemical Reference Substance.

Carbon dioxide detector tube. A cylindrical, sealed glass tube containing adsorbent filters and suitable supports for hydrazine and crystal violet indicators. The minimum value indicated is 100 µl/l or less, with a relative standard deviation of at most ±15%. Tubes can be verified with a calibration gas containing the appropriate impurity, if a negative result is obtained.

Carbon monoxide detector tube. A cylindrical, sealed glass tube containing adsorbent filters and suitable supports for di-iodine pentoxide, selenium dioxide and fuming sulfuric acid indicators. The minimum value indicated is 5 µl/l or less, with a relative standard deviation of at most ±15%. Tubes can be verified with a calibration gas containing the appropriate impurity, if a negative result is obtained.

Carbon monoxide R. CO.

A commercially available gas of suitable grade.

Cephalin TS

Procedure. Place a quantity between 0.5 and 1.0 g of acetone-dried ox brain R into a centrifuge tube, add 20 ml of acetone R, and allow to stand for 2 hours. Centrifuge for 2 minutes and decant the supernatant liquid. Dry the residue under reduced pressure, add to it 20 ml of chloroform R, and allow to stand for 2 hours, shaking frequently. Separate the solid material by filtration or centrifugation and evaporate the chloroform under reduced pressure. Suspend the residue in 5–10 ml of sodium chloride (9 g/l) TS. Solvents used to prepare cephalin TS should contain a suitable antioxidant, for example, a solution of 0.02 g/l of butylated hydroxyanisole R.

Storage. Store in a freezer or keep in a freeze-dried state.

Note: The reagent must be used within 3 months.

Chloramphenicol disodium disuccinate RS. International Chemical Reference Substance.

Chloramphenicol sodium succinate RS. International Chemical Reference Substance.

Chloride standard (5 µg/l) TS

Procedure. Weigh accurately 82.4 mg of sodium chloride R and dissolve in suf-

ficient water to produce 100 ml. Dilute 1.0 ml of this solution with water to 100 ml.

7-Chloro-1-cyclopropyl-1,4-dihydro-4-oxo-6-(piperazin-1-yl)quinoline-3-carboxylic acid RS (ciprofloxacin by-compound A). International Chemical Reference Substance.

1-Chloro-2,4 dinitrobenzene R. $C_6H_3ClN_2O_4$.
A commercially available reagent of suitable grade.
Melting point. About 144 °C.

1-Chloro-2,4 dinitrobenzene/ethanol TS
Procedure. Weigh 5 g of 1-Chloro-2,4 dinitrobenzene R and dissolve in sufficient ethanol (~750 g/l) TS to produce 100 ml.

Ciclosporin RS. International Chemical Reference Substance.

Ciclosporin U RS. International Chemical Reference Substance.

Ciprofloxacin RS. International Chemical Reference Substance.

Ciprofloxacin hydrochloride RS. International Chemical Reference Substance.

Clindamycin hydrochloride RS. International Chemical Reference Substance.

Clindamycin phosphate RS. International Chemical Reference Substance.

Colchicine RS. International Chemical Reference Substance.

1-Cyclopropyl-1,4-dihydro-4-oxo-7-(piperazin-1-yl)quinoline-3-carboxylic acid RS (ciprofloxacin desfluoro-compound). International Chemical Reference Substance.

Dacarbazine RS. International Chemical Reference Substance.

Dacarbazine related compound A RS. International Chemical Reference Substance.

Dacarbazine related compound B RS. International Chemical Reference Substance.

Dantron R. 1,8-dihydroxyanthraquinone; $C_{14}H_8O_4$.
A commercially available reagent of suitable grade.

Description. An orange, microcrystalline powder.

Solubility. Practically insoluble in water; slightly soluble in ethanol (~750 g/l) TS and ether R.

Melting point. About 193 °C.

3,3'-Diaminobenzidine tetrahydrochloride R. $C_{12}H_{14}N_4 \cdot 4HCl \cdot 2H_2O$.

A commercially available reagent of suitable grade.

Description. An almost white or slightly pink powder.

3,3'-Diaminobenzidine tetrahydrochloride (5 g/l) TS. A solution of 3,3'-diaminobenzidine tetrahydrochloride R containing 5 g of $C_{12}H_{14}N_4 \cdot 4HCl$ per litre.

Diethylphenylenediamine sulfate TS

Procedure. To 250 ml of water add about 2 ml of sulfuric acid (~1760 g/l) TS and 50 ml of disodium edetate (0.01 mol/l) VS. Dissolve 1.1 g of *N,N*-diethyl-*p*-phenylenediamine sulfate R into this solution and dilute with sufficient water to produce 1000 ml.

***N,N*-Diethyl-*p*-phenylenediamine sulfate R.** *N,N*-Diethyl-1,4-phenylenediamine sulfate; $C_{10}H_{16}N_2 \cdot H_2SO_4$.

A commercially available reagent of suitable grade.

Description. A white or slightly coloured powder.

Melting point. About 185 °C, with decomposition.

Storage. *N,N*-Diethyl-*p*-phenylenediamine sulfate R should be kept protected from light.

Diethyltoluamide RS. International Chemical Reference Substance.

Dimethyl 2,6-dimethyl-4-(2-nitrophenyl)pyridine-3,5-dicarboxylate RS. International Chemical Reference Substance.

Dimethyl 2,6-dimethyl-4-(2-nitrosophenyl)pyridine-3,5-dicarboxylate RS. International Chemical Reference Substance.

***N,N*-Dimethyloctylamine R.** Octyldimethylamine; $C_{10}H_{23}N$.

A commercially available reagent of suitable grade.

Description. A colourless liquid.

Boiling point. About 195 °C.

Dinitrogen oxide R. N_2O .

A commercially available gas of suitable grade.

1,2-Diphenylethylammonium 3-mercapto-2-methylpropanoate RS. International Chemical Reference Substance.

Dissolution media

- **Buffer pH = 1.3**

Dissolve 2 g of sodium chloride R in 800 ml of deionized water, adjust the pH to 1.3 with hydrochloric acid (~70 g/l) TS, and dilute to 1000 ml with water.

- **Buffer pH = 2.5**

Dissolve 2 g of sodium chloride R in 800 ml of deionized water, adjust the pH to 2.5 with hydrochloric acid (~70 g/l) TS, and dilute to 1000 ml with water.

- **Buffer pH = 3.5**

Dissolve 7.507 g of glycine R and 5.844 g of sodium chloride R in 800 ml of deionized water, adjust the pH to 3.5 with hydrochloric acid (~70 g/l) TS, and dilute to 1000 ml with water.

- **Buffer pH = 4.5**

Dissolve 6.8 g of potassium dihydrogen phosphate R in 900 ml of deionized water, adjust the pH to 4.5 either with hydrochloric acid (~70 g/l) TS or sodium hydroxide (~80 g/l) TS, and dilute to 1000 ml with water.

- **Buffer pH = 6.8**

Dissolve 5.53 g of disodium hydrogen phosphate R in 800 ml of deionized water, adjust the pH to 6.8 with sodium hydroxide (~80 g/l) TS, and dilute to 1000 ml with water.

- **Buffer pH = 7.2**

Dissolve 9.075 g of potassium dihydrogen phosphate R in deionized water to produce 1000 ml (solution A). Dissolve 11.87 g of disodium hydrogen phosphate R in sufficient water to produce 1000 ml (solution B). Mix 300 ml of solution A with 700 ml of solution B.

- **Gastric fluid, simulated, TS**

Dissolve 2.0 g of sodium chloride R and 3.2 g of pepsin R in 7.0 ml of hydrochloric acid (~420 g/l) TS and sufficient water to produce 1000 ml. This test solution has a pH of about 1.2.

- **Intestinal fluid, simulated, TS**

Dissolve 6.8 g of potassium dihydrogen phosphate R in 250 ml of water, mix, and add 190 ml of sodium hydroxide (0.2 mol/l) VS and 400 ml of water. Add 10.0 g of pancreatin R, mix, and adjust the resulting solution with sodium hydroxide (0.2 mol/l) VS to a pH of 7.5 ± 0.1 . Dilute with sufficient water to produce 1000 ml.

5,5'-Dithiobis(2-nitrobenzoic acid) R. 3-Carboxy-4-nitrophenyl disulfide;
 $C_{14}H_8N_2O_8S_2$.

A commercially available reagent of suitable grade.

5,5'-Dithiobis-2-nitrobenzoic acid/methanol TS

Procedure. Dissolve 0.198 g of 5,5'-Dithiobis(2-nitrobenzoic acid) R in sufficient methanol R to produce 500 ml.

Storage. Keep under refrigeration, and warm to room temperature before use.

Dithranol RS. International Chemical Reference Substance.

Doxycycline hyclate RS. International Chemical Reference Substance.

Econazole nitrate RS. International Chemical Reference Substance.

Endotoxin RS. Second WHO International Standard for Endotoxin as established in 1996, containing 10 000 IU per ampoule, approximately 1 µg of freeze-dried endotoxin from *Escherichia coli*, with 1 mg of PEG and 10 mg of lactose (distributed by the National Institute for Biological Standards and Control (NIBSC), P.O. Box 1193, Blanche Lane, South Mimms, Potters Bar, Herts. EN6 3QH, England), or another suitable preparation, the activity of which has been determined in relation to the WHO International Standard using the gelation test.

6-Epidoxycycline hydrochloride RS. International Chemical Reference Substance.

Erythromycin lactobionate RS. International Chemical Reference Substance.

Ethylene oxide R. C₂H₄O.

A commercially available gas of suitable grade.

Ethylene oxide TS

Procedure. Weigh 1.0 g of cold ethylene oxide stock solution R (equivalent to 2.5 mg of ethylene oxide) into a cold flask containing 40 g of cold macrogol 200 TS. Mix and determine the exact mass, and dilute to a calculated mass to obtain a solution containing 50 µg of ethylene oxide per 1.0 g of solution. Weigh 10.0 g into a flask and dilute with sufficient water to produce 50 ml (10 µg/ml of ethylene oxide). Dilute 10 ml of this solution to 50 ml with water (2 µg/ml of ethylene oxide).

Note: Ethylene oxide TS should be prepared immediately before use.

Ethylene oxide stock solution R

Note: All operations should be carried out in a fume-hood. The operator must protect both hands and face by wearing polyethylene protective gloves and an appropriate face mask.

Procedure. Into a dry, clean test-tube, cooled in a mixture of 1 part of sodium chloride R and 3 parts of crushed ice, introduce a slow current of ethylene oxide R gas, allowing condensation onto the inner wall of the test-tube.

Using a glass syringe, previously cooled to -10°C , inject about $300\ \mu\text{l}$ (corresponding to about $0.25\ \text{g}$) of liquid ethylene oxide R into $50\ \text{ml}$ of macrogol 200 TS. Determine the absorbed quantity of ethylene oxide by weighing before and after absorption. Dilute to $100\ \text{ml}$ with macrogol 200 TS. Mix well before use.

Assay. To $10\ \text{ml}$ of a $500\ \text{g/l}$ suspension of magnesium chloride R in dehydrated ethanol R add $20\ \text{ml}$ of hydrochloric acid/ethanol ($0.1\ \text{mol/l}$) VS, stopper the flask, shake to obtain a saturated solution, and allow to stand overnight to equilibrate. Weigh $5\ \text{g}$ of the prepared ethylene oxide stock solution R (containing about $2.5\ \text{g/l}$) into the flask and allow to stand for 30 minutes. Titrate with potassium hydroxide/ethanol ($0.1\ \text{mol/l}$) VS, determining the end-point potentiometrically. Carry out a blank titration, replacing the substance to be examined with the same quantity of macrogol 200 TS. Calculate the content of ethylene oxide in mg/g .

Storage. Keep in a tightly closed container in a refrigerator at 4°C .

1-Ethylquinaldinium iodide R. 1-Ethyl-2-methylquinolinium iodide; $\text{C}_{12}\text{H}_{14}\text{IN}$.

A commercially available reagent of suitable grade.

Description. A yellow-green solid.

Solubility. Sparingly soluble in water.

1-Ethylquinaldinium iodide (15 g/l) TS. A solution containing about $15\ \text{g}$ of 1-ethylquinaldinium iodide R per litre.

Etoposide RS. International Chemical Reference Substance.

Ferrous sulfate/hydrochloric acid TS

Procedure. Dissolve $0.45\ \text{g}$ of ferrous sulfate R in $50\ \text{ml}$ of hydrochloric acid ($0.1\ \text{mol/l}$) VS and dilute with sufficient carbon-dioxide-free water R to produce $100\ \text{ml}$.

Note: Ferrous sulfate/hydrochloric acid TS should be prepared immediately before use.

Fluoroquinolonic acid RS. International Chemical Reference Substance.

Glycine R. Aminoacetic acid; $\text{C}_2\text{H}_5\text{NO}_2$.

Description. A white, crystalline powder.

Solubility. Very soluble in water; slightly soluble in ethanol ($\sim 750\ \text{g/l}$) TS.

Assay. Determine the nitrogen by the Kjeldahl method in the test substance previously dried at 105°C for 2 hours; between 18.4 and 18.8% of N is found, corresponding to not less than 98.6% and not more than the equivalent of 100.8% of $\text{C}_2\text{H}_5\text{NO}_2$.

Insoluble matter. $10\ \text{g}$ shows not more than $1.0\ \text{mg}$ of insoluble matter ($0.1\ \text{mg/g}$).

Sulfated ash. Not more than $0.5\ \text{mg/g}$.

Chlorides. Not more than $0.1\ \text{mg}$ of Cl/g .

Sulfates. Not more than 0.05 mg of SO₄/g.

Heavy metals. Not more than 0.02 mg/g.

Iron. Not more than 0.01 mg of Fe/g, 3 ml of hydrochloric acid (~420 g/l) TS being used to facilitate solution.

Heparin RS. World Health Organization International Reference Material. Heparin, porcine, mucosal. 5th International Standard 1998. (Ampoules containing 2031 IU (distributed by the National Institute for Biological Standards and Control (NIBSC), P.O. Box 1193, Blanche Lane, South Mimms, Potters Bar, Herts, EN6 3QH, England.))

Hexylamine R. Hexaneamine; C₆H₁₅N.

A commercially available reagent of suitable grade.

Description. A colourless liquid.

Boiling point. 127–131 °C.

Refractive index. n_D^{20} = about 1.418.

Mass density. ρ_{20} = about 0.766 kg/l.

Hydrochloric acid/ethanol (1 mol/l) VS. Hydrochloric acid (~250 g/l) TS, diluted with dehydrated ethanol R to contain 36.47 g of HCl in 1000 ml of dehydrated ethanol R.

Method of standardization. Ascertain the exact concentration of the solution following the method described under hydrochloric acid (1 mol/l) VS (Vol. 1, p. 184).

Hydrochloric acid/ethanol (0.1 mol/l) VS. Hydrochloric acid (~250 g/l) TS, diluted with dehydrated ethanol R to contain 3.647 g of HCl in 1000 ml of dehydrated ethanol R.

Method of standardization. Ascertain the exact concentration of the solution following the method described under hydrochloric acid (1 mol/l) VS (Vol. 1, p. 184).

Hydrochloric acid (0.1 mol/l) LAL. Prepare from hydrochloric acid (~420 g/l) TS and water LAL. It is suitable if, after adjustment to pH 6.5–7.5, it gives a negative result under the conditions prescribed in the “Test for bacterial endotoxins” (p. 30).

1-Hydroxy-9-anthrone RS. International Chemical Reference Substance.

Hydroxylamine hydrochloride TS2

Procedure. Dissolve 3.5 g of hydroxylamine hydrochloride R in 95 ml of ethanol (~535 g/l) TS, add 0.5 ml of bromophenol blue (1 g/l) TS and sufficient potassium hydroxide/ethanol (0.5 mol/l) TS until a greenish tint is developed. Dilute the solution to 100 ml with ethanol (~535 g/l) TS.

Idoxuridine RS. International Chemical Reference Substance.

Iodine pentoxide R. Iodic anhydride; I_2O_5 .
A commercially available reagent of suitable grade.

Kaolin, light, R. Kaolin as described in the monograph in Vol. 4 (p. 186).

Kaolin suspension TS

Procedure. Immediately before use mix equal volumes of cephalin TS and a suspension containing 4 g of kaolin R in 1000 ml of sodium chloride (9 g/l) TS.

Ketoconazole RS. International Chemical Reference Substance.

Lactobionic acid R. 4-O- β -D-Galactopyranosyl-D-gluconic acid; $C_{12}H_{22}O_{12}$.
A commercially available reagent of suitable grade.

Levamisole hydrochloride RS. International Chemical Reference Substance.

Limulus amoebocyte lysate. Reconstitute the lysate as stated on the label.
For each batch, confirm the stated sensitivity as prescribed under "Sensitivity of the lysate" (page 31). The sensitivity of the lysate is defined as the lowest concentration of endotoxin which yields a firm gel under test conditions and is expressed in endotoxin units per millilitre.

Lincomycin hydrochloride RS. International Chemical Reference Substance.

Macrogol 200 R

Description. A clear, colourless or almost colourless viscous liquid.

Solubility. Very soluble in acetone R and in ethanol (~750 g/l) TS; practically insoluble in ether R and in fatty oils.

Macrogol 200 TS

Procedure. Pour 500 ml of macrogol 200 R into a 1000-ml, round-bottom flask. Evaporate any volatile components using a rotation evaporator. Heat to 60 °C and apply a vacuum with a pressure of 1.5–2.5 kPa for 6 hours.

Mefloquine hydrochloride RS. International Chemical Reference Substance.

Metacycline hydrochloride RS. International Chemical Reference Substance.

DL-Methionine RS. International Chemical Reference Substance.

Methyl violet 2B R. CI 42535; C.I. basic violet.
A commercially available reagent of suitable grade.
Melting point. About 137 °C, with decomposition.

Metronidazole benzoate RS. International Chemical Reference Substance.

Monoethanolamine (0.1 mol/l) VS. A solution of monoethanolamine R in water to contain 6.108 g of C_2H_7NO in 1000 ml.

Nifedipine RS. International Chemical Reference Substance.

Nitric acid (0.05 mol/l) VS. Nitric acid (~1000 g/l) TS, diluted with water to contain 3.151 g of HNO_3 in 1000 ml.

Method of standardization. Ascertain the exact concentration of the solution by following the method described under nitric acid (1 mol/l) VS.

Nitrogen monoxide R. NO .

Nitric oxide, washed with water.

A commercially available gas of suitable grade.

Nitrogen monoxide and nitrogen dioxide detector tube. A cylindrical, sealed glass tube containing adsorbent filters and suitable supports for an oxidizing layer Cr(VI) salt and the diphenyl-benzidine indicator. The minimum value indicated is $5 \mu\text{l/l}$ or less, with a relative standard deviation of at most $\pm 15\%$. Tubes can be verified with a calibration gas containing the appropriate impurity, if a negative result is obtained.

Nonoxinol 9 RS. International Chemical Reference Substance.

Oil detector tube. A cylindrical, sealed glass tube containing adsorbent filters and suitable supports for the sulfuric acid indicator. The minimum value indicated is 0.1 mg/m^3 , with a relative standard deviation of at most $\pm 30\%$. Tubes can be verified with a calibration gas containing the appropriate impurity, if a negative result is obtained.

Olive oil R

A commercially available reagent of suitable grade.

Ox brain, acetone-dried, R

Procedure. Cut into small pieces a fresh ox brain previously freed from vascular and connective tissue. Place in acetone R for preliminary dehydration. Complete the dehydration by pounding in a mortar 30 g of the material with successive quantities, each of 75 ml of acetone R, until a dry powder is obtained after filtration. Dry at 37°C for 2 hours or until the odour of acetone is no longer perceptible.

n-Pentane R. C_5H_{12} .

A commercially available reagent of suitable grade.

Description. A colourless, volatile liquid.

Boiling point. About 36°C .

Relative density. d_D^{20} = about 1.359.

Transmittance. Not less than 20% at 200 nm, 50% at 210 nm, 85% at 220 nm, 93% at 230 nm, and 98% at 240 nm, determined using water in the reference cell.

Perchloric acid TS

Procedure. Dilute 82 ml of perchloric acid (~1170 g/l) TS with sufficient water to produce 1000 ml (approximately 1 mol/l).

Phenobarbital RS. International Chemical Reference Substance.

Phosphate buffer, pH 7.2, TS

Procedure. Dissolve 6.80 g of potassium dihydrogen phosphate R and 1.40 g of sodium hydroxide R in sufficient water to produce 1000 ml.

Phosphoric acid (~20 g/l) TS

Procedure. To 23 g of phosphoric acid (~1440 g/l) TS add 987 g of water and mix.

Phosphoric acid (~2.8 g/l) TS

Procedure. Dilute 2 ml of phosphoric acid (~1440 g/l) TS with sufficient water to produce 100 ml.

Plasma substrate R

Note: Use water-repellent equipment (made from materials such as suitable plastics or suitably silicone-treated glass) for taking and handling blood.

Procedure. Collect a sufficient volume of blood from each of at least 5 sheep. A 285-ml volume of blood collected into 15 ml of anticoagulant solution is recommended but smaller volumes may be collected. The blood should be taken either from a live animal or at the time of slaughter, using a needle attached to a cannula that is long enough to reach the bottom of the collecting flask. Discard the first few ml and collect only free-flowing blood. Collect the blood in a sufficient quantity of an anticoagulant solution containing 8.7 g of sodium citrate R and 4 mg of aprotinin R in 100 ml of water to give a final ratio of blood to anticoagulant solution of 19 to 1. During and immediately after collection, swirl the flask gently to ensure mixing but do not allow frothing to occur. When collection is complete, close the flasks and cool to a temperature between 10 and 15 °C. Then pool the contents of all the flasks, with the exception of any that shows obvious haemolysis or clots, and keep the pooled blood at 10–15 °C. Within 4 hours of collection, centrifuge the pooled and cooled blood at a speed of 1000–2000 g^1 for 30 minutes. Separate the supernatant liquid and centrifuge again at 5000 g for 30 minutes (*Note:* Faster centrifugation (20 000 g) may be necessary to clarify the plasma, but filtration procedures should not be used.) Separate the super-

¹ Acceleration due to gravity = 9.81 m/s².

nant liquid and immediately mix thoroughly and distribute the plasma substrate R into small stoppered containers in portions sufficient for a complete heparin assay (10–30 ml). Without delay, rapidly cool to a temperature below -70°C by immersing the containers in liquid nitrogen and store at a temperature below -30°C . The plasma is suitable for use as plasma substrate R in the assay for heparin if, under the conditions of the assay, it gives a clotting time appropriate to the method of detection used, and if it provides reproducible, steep, log dose–response curves. Just before use thaw the quantity of plasma substrate R required in a water-bath at 37°C and gently swirl until thawing is complete; once thawed it should be kept between 10 and 20°C and used without delay. The thawed plasma substrate R may be slightly centrifuged if necessary, but do not use any filtration procedures.

Polydimethylsiloxane R

A commercially available reagent of suitable grade for use in gas chromatography.

Potassium hydroxide/ethanol (0.1 mol/l) VS. Potassium hydroxide R, dissolved in ethanol (~ 710 g/l) TS to contain 5.610 g of KOH in 1000 ml.

Method of standardization. Ascertain the exact concentration of the solution following the method described under potassium hydroxide (1 mol/l) VS (Vol. 1, p. 199).

Potassium hydroxide (~ 560 g/l) TS. A solution of potassium hydroxide R containing about 560 g of KOH per litre.

Potassium iodide (160 g/l) TS. A solution of potassium iodide R containing about 160 g of KI per litre.

Potassium iodobismuthate/acetic acid TS

Procedure. Dissolve 8 g of potassium iodide R in 20 ml of water and add to it a solution composed of 0.85 g of bismuth oxynitrate R dissolved in 40 ml of water and 10 ml of glacial acetic acid R.

Potassium permanganate (1 g/l) TS. A solution of potassium permanganate R containing about 1 g of KMnO_4 per litre.

Proguanil hydrochloride RS. International Chemical Reference Substance.

Retinol acetate RS. International Chemical Reference Substance.

Retinol palmitate RS. International Chemical Reference Substance.

Retinol propionate RS. International Chemical Reference Substance.

Silica gel for chromatography R

A very finely divided (3–10 μm) silica gel. The particle size is indicated after the name of the reagent in the tests where it is used.

Description. A fine, white, homogeneous powder.

Solubility. Practically insoluble in water and ethanol (~750 g/l) TS.

Sodium chloride (300 g/l) TS. A solution of sodium chloride R containing about 300 g of NaCl per litre.

Sodium chloride (9 g/l) TS. A solution of sodium chloride R containing about 9 g of NaCl per litre.

Sodium dithionite R. Sodium hydrosulfite, sodium sulfoxylate; $\text{Na}_2\text{O}_4\text{S}_2$.

Description. A white or greyish white, crystalline powder.

Solubility. Very soluble in water, slightly soluble in ethanol (~750 g/l) TS.

Note: Sodium dithionite R oxidizes in air.

Sodium dithionite (200 g/l) TS. A solution of sodium dithionite R containing about 200 g of $\text{Na}_2\text{O}_4\text{S}_2$ per litre.

Sodium hexanesulfonate R. $\text{C}_6\text{H}_{13}\text{NaO}_3\text{S}$.

A commercially available reagent of suitable grade.

Sodium hydroxide (0.1 mol/l) LAL. Prepare from sodium hydroxide R and water LAL. It is suitable if, after adjustment to pH 6.5–7.5, it gives a negative result under the conditions prescribed in the “Test for bacterial endotoxins” (p. 30).

Sodium hypobromite TS

Procedure. Dissolve 2.5 g of sodium hydroxide R in 7.5 ml of water, add 0.5 ml of bromine R and a sufficient quantity of water to produce 10 ml.

Note: Sodium hypobromite TS must be freshly prepared.

Sodium nitrate R. NaNO_3 .

A commercially available reagent of suitable grade.

Sodium octanesulfonate R. $\text{C}_8\text{H}_{17}\text{NaO}_3\text{S}$.

Contains not less than 98.0% of $\text{C}_8\text{H}_{17}\text{NaO}_3\text{S}$.

A commercially available reagent of suitable grade.

Absorbance. A 0.05 g/ml solution of a 1-cm layer measured at a wavelength of about 250 nm has an absorbance of not greater than 0.01.

Sodium standard (200 μg Na/ml) TS

Procedure. Dissolve 0.5084 g of sodium chloride R, previously dried at 100–105 °C for 3 hours, in sufficient water to produce 1000 ml.

Sodium thiosulfate (0.002 mol/l) VS. Sodium thiosulfate R, dissolved in water to contain 0.316 g of $\text{Na}_2\text{S}_2\text{O}_3$ in 1000 ml.

Method of standardization. Ascertain the exact concentration of the solution following the method described under sodium thiosulfate (0.1 mol/l) VS (Vol. 1, p. 207, and Vol. 2, p. 319).

Sulfadiazine RS. International Chemical Reference Substance.

Supports for high-performance liquid chromatography

- **Stationary phase A.** Particles of silica gel, the surface of which has been modified with chemically bonded octadecylsilyl groups.
- **Stationary phase B.** Particles of silica gel, the surface of which has been modified with chemically bonded octylsilyl groups.
- **Stationary phase C.** Particles of porous silica.
- **Stationary phase D.** Particles of styrene-divinylbenzene copolymer.

Tamoxifen citrate E-isomer RS. International Chemical Reference Substance.

Tetrabutylammonium hydrogen sulfate R. TBAHS; $\text{C}_{16}\text{H}_{37}\text{NO}_4\text{S}$.

A commercially available reagent of suitable grade.

Description. Colourless crystals or a white, crystalline powder.

Solubility. Freely soluble in water and methanol R; soluble in ethanol (~750 g/l) TS producing a slightly hazy, colourless solution.

Absorbance. A 0.05 g/ml solution of a 1-cm layer measured at a wavelength between 240 nm and 300 nm has an absorbance of not greater than 0.05.

Melting range. 169–173 °C.

Thiopental RS. International Chemical Reference Substance.

Triketohydrindene/butanol/acetic acid TS

Procedure. Prepare a 20 mg/ml solution of triketohydrindene hydrate R in a mixture of 95 volumes of 1-butanol R and 5 volumes of acetic acid (~120 g/l) TS.

Trinitrophenol/ethanol TS

Procedure. Dissolve 33 g of trinitrophenol R in sufficient ethanol (~750 g/l) TS to produce 1000 ml.

Tropicamide RS. International Chemical Reference Substance.

Vanillin/sulfuric acid TS1

Procedure. Dissolve 5 g of vanillin R in 100 ml of sulfuric acid (~1760 g/l) TS.

Note: Vanillin/sulfuric acid TS1 should be freshly prepared.

Vanillin/sulfuric acid TS2

Procedure. Dissolve 1 g of vanillin R in sufficient ethanol (~750 g/l) TS to produce 100 ml. Carefully add, drop by drop, 2 ml of sulfuric acid (~1760 g/l) TS.

Note: Vanillin/sulfuric acid TS2 must be used within 48 hours.

Water for injections R. Water for injections as described in Vol. 4, p. 132.

Water LAL. Water is suitable if it gives a negative result under the conditions prescribed in the "Test for bacterial endotoxins" (p. 30). It may be prepared by distilling water three times in an apparatus fitted with an effective device to prevent the entrainment of droplets, or by other means which give water of the requisite quality.

Water vapour detector tube. A cylindrical, sealed glass tube containing adsorbent filters and suitable supports for the magnesium perchlorate indicator. The minimum value indicated is 60 $\mu\text{l/l}$ or less, with a relative standard deviation of at most $\pm 20\%$.

Amendments and corrigenda to
Volumes 1, 2, 3, and 4

Volume 1. General methods of analysis

Chromatography

Page 88

High-pressure liquid chromatography

and

Volume 3. Amendments and corrigenda to Volumes 1 and 2

Page 373

High-performance liquid chromatography

Replace the text with the following:

High-performance liquid chromatography

Introduction

High-performance liquid chromatography (HPLC) is a separation technique that can be used for the analysis of organic molecules and ions. HPLC is based on mechanisms of adsorption, partition, ion exchange or size exclusion, depending on the type of stationary phase used. HPLC involves a solid stationary phase, normally packed inside a stainless-steel column, and a liquid mobile phase. Separation of the components of a solution results from the difference in the relative distribution ratios of the solutes between the two phases.

HPLC can be used to assess the purity and/or determine the content of many pharmaceutical substances. It can also be used to determine enantiomeric composition, using suitably modified mobile phases or chiral stationary phases. Individual separation mechanisms of adsorption, partition, ion exchange and size exclusion rarely occur in isolation, since several principles act to a certain degree simultaneously.

Apparatus

The apparatus consists of a pumping system, an injector, a chromatographic column, stationary and mobile phases, connecting tubing and fittings, a detector, and a data collection device (computer, integrator or recorder).

Pumping system

HPLC pumping systems are required to deliver metered amounts of mobile phase at a constant flow rate. Pumping systems that deliver solvent from one or more reservoirs are available. Pressure fluctuations should be minimized, e.g. by passing the pressurized solvent through a pulse-dampening device. Tubing and connections should be capable of withstanding the pressures developed by the pumping system. Many HPLC pumps are fitted with a facility for “bleeding” the system of entrapped air bubbles.

Modern computer- or microprocessor-controlled pumping systems are capable of accurately delivering a mobile phase of either constant (isocratic elution) or varying (gradient elution) composition, according to a defined programme. In the case of gradient elution, solvent mixing can be achieved on either the low- or high-pressure side of the pump(s). Depending on the flow rate and composition of the mobile phase, operating pressures of up to 42 000 kPa (6000 psi) can be generated during routine analysis.

Injector

The sample solution is usually introduced into the flowing mobile phase at or near the head of the column using an injection system based on an injection valve design which can operate at high pressure. Such an injection system has a fixed-loop or a variable volume device which can be operated manually or by an auto-sampler. Partial filling of loops may lead to poorer injection volume precision.

Chromatographic column

Columns are usually made of polished stainless steel, are between 50 and 300 mm long, and have an internal diameter of between 2 and 5 mm. They are commonly filled with a stationary phase with a particle size of 5–10 µm. Columns with internal diameters of less than 2 mm are often referred to as microbore columns. Ideally, the temperature of the mobile phase and the column should be kept constant during an analysis. Most separations are performed at ambient temperature, but columns may be heated to give better efficiency. Normally, columns should not be heated above 60 °C because of the potential for stationary phase degradation or changes occurring to the composition of the mobile phase.

Stationary phases

Separation of pharmaceuticals is usually achieved by partition of compounds in the test solution between the mobile and the stationary phases. HPLC systems consisting of polar stationary phases and nonpolar mobile phases are described as normal-phase chromatography; those with nonpolar stationary phases and polar mobile phases are called reversed-phase chromatography.

There are many types of stationary phases used in HPLC including:

- unmodified silica, alumina, or porous graphite, used in normal-phase chromatography, where separation is based on differences in adsorption;
- a variety of chemically modified supports prepared from polymers, silica, or porous graphite, used in reverse-phase HPLC, where separation is based principally on partition of the molecules between the mobile phase and the stationary phase;
- resins or polymers with acid or basic groups, used in ion-exchange chromatography, where separation is based on competition between the ions to be separated and those in the mobile phase;
- porous silica or polymers, used in size-exclusion chromatography, where separation is based on the relative molecular mass of the molecules.

Most separations are based on partition mechanisms using chemically modified silica as the stationary phase and polar solvents as the mobile phase (reverse-phase HPLC). The surface of the support, e.g. the silanol groups of silica, is reacted with various silane reagents to produce covalently bonded silyl derivatives covering a varying number of active sites on the surface of the support. The nature of the bonded phase is an important parameter for determining the separation properties of the chromatographic system.

Commonly used bonded phases are shown below.

Common bonded phases		
octyl	Si-(CH ₂) ₇ -CH ₃	C ₈
octadecyl	Si-(CH ₂) ₁₇ -CH ₃	C ₁₈
phenyl	Si-(CH ₂) ₃ -C ₆ H ₅	C ₆ H ₅
cyanopropyl	Si-(CH ₂) ₃ -CN	CN
aminopropyl	Si-(CH ₂) ₃ -NH ₂	NH ₂
diol	Si-(CH ₂) ₃ -OCH(OH)-CH ₂ -OH	

For the separation of enantiomers, special chemically modified stationary phases (chiral chromatography) are available, e.g. cyclodextrins, albumins, etc.

As a guide, silica-based reverse-phase columns are generally considered to be stable in mobile phases with an apparent pH in the range 2.0–8.0, but the column manufacturer's instructions should be consulted before using the column. Columns containing particles of polymeric materials such as styrene divinylbenzene copolymer are stable over a wider pH range.

Analysis using normal-phase HPLC with unmodified silica, porous graphite or polar chemically modified silica (e.g. cyanopropyl or diol) as the stationary phase and a nonpolar mobile phase is still employed in certain cases.

For analytical separations the particle size of the most commonly used stationary phases varies between 3 μm and 10 μm . The particles may be spherical or irregular, of different porosities and specific surface area. In the case of reversed-phase, the extent of bonding of the stationary phase is expressed as the carbon-loading. Furthermore, stationary phases may be "end-capped", i.e. the number of residual silanol groups is reduced by methylation. These parameters contribute to the chromatographic behaviour of a particular stationary phase. Tailing of peaks, particularly for basic substances, can occur when residual silanol groups are present.

Mobile phases

The choice of mobile phases is based on the desired retention behaviour and the physicochemical properties of the analyte.

For normal-phase HPLC using unmodified stationary phases, lipophilic solvents should be employed. The presence of water in the mobile phase must be avoided as this will reduce the efficiency of the stationary phase. In reverse-phase HPLC aqueous mobile phases, with and without organic modifiers, are used.

The mobile phase should be filtered through suitable membrane-type filters with a porosity of 0.45 μm to remove mechanical particles. Multicomponent mobile phases should be prepared by measuring the required volumes (unless masses are specified) of the individual components, followed by manual or mechanical mixing. Alternatively, the solvents may be delivered by the individual pumps or proportioning valves of the liquid chromatograph and mixed according to the desired proportion. Solvents are normally degassed by sparging with helium or by sonification before pumping to avoid the creation of gas bubbles in the detector cell.

If an ultraviolet detector is employed, the solvents used for the preparation of the mobile phase should be free of stabilizers and transparent at the wavelength of detection. Adjustment of the pH, if necessary, should be made using the aqueous component of the mobile phase and not the mixture. Buffers of high molarity should be avoided in the preparation of mobile phases. If buffers are used, the system should be rinsed with an adequate mixture of water and the organic modifier of the mobile phase to prevent crystallization of salts.

Mobile phases may contain other components, e.g. a counter-ion for ion-pair chromatography or a chiral selector for chiral chromatography using an achiral stationary phase.

Connecting tubing and fittings

The potential efficiency of an analytical column may never be achieved because of the design limitations of injectors and detectors. The connections between injector/column, column/detector, and/or detector/detector may compromise the overall efficiency of the system and any fittings should be of the "zero dead volume" (ZDV) type. It is recommended that minimum lengths of capillary tubing with a maximum internal diameter of 0.25 mm be used for these fittings to minimize band spreading.

Detectors

Ultraviolet/visible (UV/vis) absorption spectrometers are the most commonly used detectors for pharmaceutical analysis. In specific cases, fluorescence spectrophotometers, differential refractometers, electrochemical detectors, light-scattering detectors, mass spectrometers, or other special detectors may be used. Where an analyte possesses a chromophoric group that absorbs UV/vis radiation, the UV/vis detector is the most appropriate because of its sensitivity and stability. Such a detector is not suitable for detecting analytes with very weak chromophores.

A variant on the UV/vis type of detector, which is becoming increasingly popular because of its ability to furnish detailed spectral information, is the diode array spectrophotometer. This type of detector acquires absorbance data over a certain UV/vis range and can provide chromatograms at multiple, selectable wavelengths, together with spectra for the eluted peaks. In addition, the detector and accompanying computer programmes can be used to assess the spectral homogeneity of peaks, which may provide information on the chromatographic purity of the peaks. This can be especially useful in method development and validation.

Enhanced sensitivity may be achieved in certain cases by using pre-column or post-column derivatization techniques. (These techniques are to be avoided for the control of impurities.)

Data collection devices

Signals from the detector may be collected on chart recorders or electronic integrators that vary in complexity and in their ability to process, store, and reprocess chromatographic data. The data storage capacity of these devices is usually limited.

Modern data stations are computer based and have a large storage capacity to collect, process, and store data for possible subsequent reprocessing. Analytical reports can often be customized to the needs of the analyst.

Integration of peak areas and the setting of threshold levels are not normally problematic in an assay since the peak of the substance to be analysed should

be free of interference. However, in a test for impurities, the selection of the peak area integrator parameters becomes very important, particularly when baseline separations are not always attainable. If baseline separations cannot be obtained, valley-to-valley integration should be employed.

HPLC allows limits to be set for individual impurities and for the sum of impurities, but there is a level at which peaks should not be integrated. This “disregard level” is set in relation to the area of the peak in the chromatogram of the prescribed reference solution and is usually equivalent to 0.05% of the substance being examined.

System suitability

The system suitability test represents an integral part of the method and is used to ensure the adequate performance of the chosen chromatographic system.

Efficiency, capacity factor, resolution factor, and symmetry factor are the parameters that are normally used in assessing the column performance; these terms are defined below. Factors that can affect chromatographic behaviour include mobile phase composition, temperature, ionic strength and apparent pH, flow rate, and column length, and stationary phase characteristics such as porosity, particle size and type, specific surface area, and, in the case of reversed-phase supports, the type of chemical modification, carbon loading, and end-capping.

Efficiency (N)

The efficiency of a chromatographic column is defined in terms of the number of theoretical plates (*N*) and can be calculated using the following formula:

$$N = 5.54 \frac{t_R^2}{W_h^2}$$

where

t_R = retention time or the baseline distance between the point of injection and the perpendicular dropped from the maximum of the peak of interest.

W_h = the width of the peak of interest determined at half peak height, measured in the same units as t_R .

The number of theoretical plates can be expressed per metre (N'):

$$N' = \frac{N}{l}$$

where

l = length of column in metres.

Capacity factor (mass distribution ratio, D_m)

The capacity factor or mass distribution ratio is defined as follows:

$$D_m = \frac{\text{amount of solute in stationary phase}}{\text{amount of solute in mobile phase}}$$

This factor determines the retention of a solute and can be calculated from the chromatogram using the following formula:

$$D_m = \frac{(t_R - t_M)}{t_M}$$

where

t_R = retention time of the solute

t_M = retention time of an unretained component

A low D_m value indicates that the peak elutes close to the solvent front, which may compromise selectivity. A minimum D_m value of 1 is recommended for the peak of interest.

The retention time of the test substance can be varied, if necessary, by changing the relative proportion or composition of solvents in the mobile phase. Generally, an increase in the proportion of a more polar solvent will lead to a shorter retention time on a normal-phase column and a longer retention time on a reversed-phase column.

Resolution factor (R_s)

The resolution between two peaks of similar height in a chromatogram can be calculated using the following formula:

$$R_s = \frac{1.18(t_{R2} - t_{R1})}{(W_{b1} + W_{b2})}$$

where

t_{R1} and t_{R2} = retention times or baseline distances between the point of injection and the perpendicular dropped from the maximum of each of the two peaks.

W_{b1} and W_{b2} = the respective peak widths determined at half peak height, measured in the same units as t_{R1} and t_{R2} .

The value of R_s for a baseline separation between peaks of similar height should be at least 1.5.

Relative retention

The relative retention (r) is calculated as an estimate using the following formula:

$$r = \frac{t_{R2} - t_M}{t_{R1} - t_M}$$

where

t_{R2} = retention time of the peak of interest

t_{R1} = retention time of the reference peak

t_M = retention time of an unretained component

Symmetry factor (A_s)

The symmetry factor for a peak can be calculated using the following formula:

$$A_s = \frac{W_x}{2d}$$

where

W_x = peak width at 5% of peak height, measured from the baseline.

d = baseline distance between the perpendicular dropped from the peak maximum and the leading edge of the peak at 5% of the peak height, measured in the same units as W_x .

Values of A_s which are greater than 2 may lead to incorrect integration, resulting in erroneous quantitation. The main factors that influence peak symmetry depend upon retention, solvent effects, incompatibility of the solute with the mobile phase, or development of an excessive void at the inlet of the column. In reversed-phase chromatography, adsorption phenomena due to the presence of residual silanol groups in the stationary phase may lead to tailing (poor peak symmetry).

Repeatability

Unless otherwise stated in the "Assay" of the individual monograph, the relative standard deviation of peak areas or peak heights for a series of injections of reference solutions bracketing groups of test solutions should not exceed 2.0%.

In a "Related substances" test the relative standard deviation of peak areas or peak heights for three replicate injections of the reference solution should not exceed 5.0%, unless otherwise stated in the individual monograph.

In a series of injections the relative standard deviation of the retention time of the principal peak should not exceed 1.0%.

Recommended procedure

To equilibrate the column, allow the mobile phase to flow through the chromatographic system until the baseline is stable at the flow rate specified in the individual monograph (about 30 minutes). Prepare the prescribed test and reference solutions as directed. Inject the prescribed reference solution and, if necessary, adjust the detector and/or recorder response to produce an adequate peak size. For chart recorders and integrators this should be at least 50% of the full-scale deflection of the principal peak in the chromatograms obtained with the reference solution. Ensure that the criteria for system suitability are met.

The reference solution should be injected at the start, at regular intervals during, and at the end of a series of assays (e.g. every 2–4 samples). Both the reference and the test solutions should be injected in duplicate.

In determining the component composition of a complex mixture, a “normalization” procedure, based on the calculation of individual peak areas as a percentage of the total area of all the peaks, may be used where the relative response factors of the individual components are similar. The response factor is relative, being the response of the equal mass of one substance relative to that of another according to the conditions described in the test. For example, when an HPLC test with UV/vis detection is used for the control of impurities, the wavelength of detection should be such that the substance and its impurities have similar responses. If an impurity has a significantly different response (more than $\pm 20\%$) from that of the substance being examined, the preferred manner of limiting this impurity is to use a reference substance of the impurity. If a reference substance is not available, the response factors of the potential impurities relative to those of the substance being examined are determined during method development. Subsequently, the derived correction factors (i.e. the reciprocals of the response factors) are applied, if necessary, as described in the individual monograph.

If gradient elution is specified in the monograph, an instrument equipped with a special pumping system capable of delivering a mobile phase of continuously varied composition is needed. The mobile phase composition changes from the initial composition within a fixed period of time, as specified in the monograph. Where the mobile phase composition is varied at a linear gradient elution, perform a blank run to identify any interfering peaks by injecting the solvent specified for preparing the test solutions. Allow sufficient time for equilibration when the mobile phase is reset to the initial composition for the next injection.

Volume 2. Quality specifications

Aminophyllinum

Page 33

Add the following statement and test:

Additional requirements for Aminophylline for parenteral use

Complies with the monograph for "Parenteral preparations" (see Vol. 4, p. 36).

Bacterial endotoxins. Carry out the test as described under "Test for bacterial endotoxins" (p.30); contains not more than 1.0IU of endotoxin RS per mg.

Ampicillinum natricum

Page 42

Additional requirements for Ampicillin sodium for sterile use

Add the following statement:

Complies with the "Test for sterility of non-injectable preparations" (see p.32).

Pyrogens

Delete the test and add the following:

Bacterial endotoxins. Carry out the test as described under "Test for bacterial endotoxins" (p.30); contains not more than 0.15IU of endotoxin RS per mg of ampicillin.

Atropini sulfas

Page 44

Add the following statements and test:

Additional requirements for Atropine sulfate for parenteral use

Complies with the monograph for "Parenteral preparations" (see Vol. 4, p. 36).

Bacterial endotoxins. Carry out the test as described under "Test for bacterial endotoxins" (p.30); contains not more than 55.6IU of endotoxin RS per mg.

Additional requirement for Atropine sulfate for sterile use

Complies with the "Test for sterility of non-injectable preparations" (see p.32).

Benzylpenicillinum kalicum

Page 50

Additional requirements for Benzylpenicillin potassium for sterile use

Add the following statement:

Complies with the "Test for sterility of non-injectable preparations" (see p.32).

Pyrogens

Delete the test and add the following:

Bacterial endotoxins. Carry out the test as described under "Test for bacterial endotoxins" (p.30); contains not more than 0.01 IU of endotoxin RS per mg of benzylpenicillin.

Benzylpenicillinum natricum

Page 53

Additional requirements for Benzylpenicillin sodium for sterile use

Add the following statement:

Complies with the "Test for sterility of non-injectable preparations" (see p.32).

Pyrogens

Delete the test and add the following:

Bacterial endotoxins. Carry out the test as described under "Test for bacterial endotoxins" (p.30); contains not more than 0.01 IU of endotoxin RS per mg of benzylpenicillin.

Bupivacaini hydrochloridum

Page 59

Add the following statement and test:

Additional requirements for Bupivacaine hydrochloride for parenteral use

Complies with the monograph for "Parenteral preparations" (see Vol. 4, p. 36).

Bacterial endotoxins. Carry out the test as described under "Test for bacterial endotoxins" (p. 30); contains not more than 2.5IU of endotoxin RS per mg.

Calcii gluconas

Page 61

Add the following statement and test:

Additional requirements for Calcium gluconate for parenteral use

Complies with the monograph for "Parenteral preparations" (see Vol. 4, p. 36).

Bacterial endotoxins. Carry out the test as described under "Test for bacterial endotoxins" (p. 30); contains not more than 167 IU of endotoxin RS per g.

Chloroquini phosphas

Page 69

Add the following statement:

Additional requirement for Chloroquine phosphate for parenteral use

Complies with the monograph for "Parenteral preparations" (see Vol. 4, p. 36).

Chloroquini sulfas

Page 71

Replace the text with the following:

Assay. Dissolve about 0.4 g, accurately weighed, in 20 ml of glacial acetic acid R1 with the aid of heat (preferably under a reflux condenser), cool, and add 20 ml of dioxan R. Titrate with perchloric acid (0.1 mol/l) VS as described under "Non-aqueous titration", Method A (Vol. 1, p. 131). Each ml of perchloric acid (0.1 mol/l) VS is equivalent to 41.8 mg of $C_{18}H_{26}ClN_3 \cdot H_2SO_4$.

Add the following statement:

Additional requirement for Chloroquine sulfate for parenteral use

Complies with the monograph for "Parenteral preparations" (see Vol. 4, p. 36).

Chlorphenamini hydrogenomaleas

Page 73

Add the following statement and test:

Additional requirements for Chlorphenamine hydrogen maleate for parenteral use

Complies with the monograph for "Parenteral preparations" (see Vol. 4, p. 36).

Bacterial endotoxins. Carry out the test as described under "Test for bacterial endotoxins" (p. 30); contains not more than 8.8IU of endotoxin RS per mg.

Chlorpromazini hydrochloridum

Page 75

Add the following statement and test:

Additional requirements for Chlorpromazine hydrochloride for parenteral use

Complies with the monograph for "Parenteral preparations" (see Vol. 4, p. 36).

Bacterial endotoxins. Carry out the test as described under "Test for bacterial endotoxins" (p. 30); contains not more than 6.9IU of endotoxin RS per mg.

Cloxacillinum natricum

Page 80

Additional requirements for Cloxacillin sodium for sterile use

Add the following statement:

Complies with the "Test for sterility of non-injectable preparations" (see p. 32).

Undue toxicity

Delete the test

Pyrogens

Delete the test and add the following:

Bacterial endotoxins. Carry out the test as described under “Test for bacterial endotoxins” (p. 30); contains not more than 40IU of endotoxin RS per mg of cloxacillin.

Diazepamum

Page 99

Add the following statement and test:

Additional requirements for Diazepam for parenteral use

Complies with the monograph for “Parenteral preparations” (see Vol. 4, p. 36).

Bacterial endotoxins. Carry out the test as described under “Test for bacterial endotoxins” (p. 30); contains not more than 11.6IU of endotoxin RS per mg.

Digitoxinum

Page 107

Add the following statement and test:

Additional requirements for Digitoxin for parenteral use

Complies with the monograph for “Parenteral preparations” (see Vol. 4, p. 36).

Bacterial endotoxins. Carry out the test as described under “Test for bacterial endotoxins” (p. 30); contains not more than 111.0IU of endotoxin RS per mg.

Digoxinum

Page 109

Add the following statement and test:

Additional requirements for Digoxin for parenteral use

Complies with the monograph for “Parenteral preparations” (see Vol. 4, p. 36).

Bacterial endotoxins. Carry out the test as described under “Test for bacterial endotoxins” (p. 30); contains not more than 200.0IU of endotoxin RS per mg.

Epinephrini hydrogenotartras

Page 112

Add the following statement:

Additional requirements for Epinephrine hydrogen tartrate for parenteral use

Complies with the monograph for "Parenteral preparations" (see Vol. 4, p. 36).

Epinephrinum

Page 114

Add the following statement and test:

Additional requirements for Epinephrine for parenteral use

Complies with the monograph for "Parenteral preparations" (see Vol. 4, p. 36).

Bacterial endotoxins. Carry out the test as described under "Test for bacterial endotoxins" (p. 30); contains not more than 357.0IU of endotoxin RS per mg.

Ergometrini hydrogenomaleas

Page 116

Add the following statement and test:

Additional requirements for Ergometrine hydrogen maleate for parenteral use

Complies with the monograph for "Parenteral preparations" (see Vol. 4, p. 36).

Bacterial endotoxins. Carry out the test as described under "Test for bacterial endotoxins" (p. 30); contains not more than 700.0IU of endotoxin RS per mg.

Fluphenazini decanoas

Page 128

Add the following statement:

Additional requirement for Fluphenazine decanoate for parenteral use

Complies with the monograph for "Parenteral preparations" (see Vol. 4, p. 36).

Fluphenazini enantas

Page 130

Add the following statement:

Additional requirement for Fluphenazine enantate for parenteral use

Complies with the monograph for "Parenteral preparations" (see Vol. 4, p. 36).

Furosemidum

Page 134

Add the following statement and test:

Additional requirements for Furosemide for parenteral use

Complies with the monograph for "Parenteral preparations" (see Vol. 4, p. 36).

Bacterial endotoxins. Carry out the test as described under "Test for bacterial endotoxins" (p. 30); contains not more than 3.6 IU of endotoxin RS per mg.

Glucosum

Page 137

Add the following statement and test:

Additional requirements for Glucose for parenteral use

Complies with the monograph for "Parenteral preparations" (see Vol. 4, p. 36).

Bacterial endotoxins. Carry out the test as described under "Test for bacterial endotoxins" (p. 30); contains not more than 0.5 IU of endotoxin RS per mg.

Haloperidolum

Page 141

Add the following statement and test:

Additional requirements for Haloperidol for parenteral use

Complies with the monograph for "Parenteral preparations" (see Vol. 4, p. 36).

Bacterial endotoxins. Carry out the test as described under “Test for bacterial endotoxins” (p. 30); contains not more than 71.4IU of endotoxin RS per mg.

Iodum

Page 157

Add the following statement:

Additional requirement for Iodine for parenteral use

Complies with the monograph for “Parenteral preparations” (see Vol. 4, p. 36).

Isoprenalini hydrochloridum

Page 160

Add the following statement and test:

Additional requirements for Isoprenaline hydrochloride for parenteral use

Complies with the monograph for “Parenteral preparations” (see Vol. 4, p. 36).

Bacterial endotoxins. Carry out the test as described under “Test for bacterial endotoxins” (p. 30); contains not more than 1250.0IU of endotoxin RS per mg.

Isoprenalini sulfas

Page 162

Add the following statement and test:

Additional requirements for Isoprenaline sulfate for parenteral use

Complies with the monograph for “Parenteral preparations” (see Vol. 4, p. 36).

Bacterial endotoxins. Carry out the test as described under “Test for bacterial endotoxins” (p. 30); contains not more than 1250.0IU of endotoxin RS per mg.

Kalii chloridum

Page 165

Additional requirements for Potassium chloride for parenteral use

Add the following statement and test:

Complies with the monograph for "Parenteral preparations" (see Vol. 4, p. 36).

Bacterial endotoxins. Carry out the test as described under "Test for bacterial endotoxins" (p. 30); contains not more than 8.8IU of endotoxin RS per milliequivalence.

Add the following statement:

Additional requirement for Potassium chloride for sterile use

Complies with the "Test for sterility of non-injectable preparations" (see p. 32).

Lidocaini hydrochloridum

Page 171

Add the following statement and test:

Additional requirements for Lidocaine hydrochloride for parenteral use

Complies with the monograph for "Parenteral preparations" (see Vol. 4, p. 36).

Bacterial endotoxins. Carry out the test as described under "Test for bacterial endotoxins" (p. 30); contains not more than 1.1IU of endotoxin RS per mg.

Mannitolum

Page 179

Add the following statement and test:

Additional requirements for Mannitol for parenteral use

Complies with the monograph for "Parenteral preparations" (see Vol. 4, p. 36).

Bacterial endotoxins. Carry out the test as described under "Test for bacterial endotoxins" (p. 30); contains not more than 4IU of endotoxin RS per g for dosage forms with a concentration of less than 100g/l of mannitol, and a limit of not more than 2.5IU of endotoxin RS per g for dosage forms with a concentration of 100g/l or more of mannitol.

Metronidazolium

Page 185

Add the following statement and test:

Additional requirements for Metronidazole for parenteral use

Complies with the monograph for "Parenteral preparations" (see Vol. 4, p. 36).

Bacterial endotoxins. Carry out the test as described under "Test for bacterial endotoxins" (p. 30); contains not more than 0.35 IU of endotoxin RS per mg.

Morphini hydrochloridum

Page 187

Add the following statement:

Additional requirement for Morphine hydrochloride for parenteral use

Complies with the monograph for "Parenteral preparations" (see Vol. 4, p. 36).

Morphini sulfas

Page 189

Add the following statement and test:

Additional requirements for Morphine sulfate for parenteral use

Complies with the monograph for "Parenteral preparations" (see Vol. 4, p. 36).

Bacterial endotoxins. Carry out the test as described under "Test for bacterial endotoxins" (p. 30); contains not more than 14.29 IU of endotoxin RS per mg.

Natrii chloridum

Page 191

Add the following statement and test:

Additional requirements for sodium chloride for parenteral use

Complies with the monograph for "Parenteral preparations" (see Vol. 4, p. 36).

Bacterial endotoxins. Carry out the test as described under "Test for bacterial endotoxins" (p. 30); contains not more than 5.0 IU of endotoxin RS per g.

Natrii hydrogenocarbonas

Page 193

Add the following statement and test:

Additional requirements for sodium hydrogen carbonate for parenteral use

Complies with the monograph for "Parenteral preparations" (see Vol. 4, p. 36).

Bacterial endotoxins. Carry out the test as described under "Test for bacterial endotoxins" (p. 30); contains not more than 5.0 IU of endotoxin RS per milliequivalence.

Phenytoinum natricum

Page 219

Add the following statement and test:

Additional requirements for Phenytoin sodium for parenteral use

Complies with the monograph for "Parenteral preparations" (see Vol. 4, p. 36).

Bacterial endotoxins. Carry out the test as described under "Test for bacterial endotoxins" (p. 30); contains not more than 0.3 IU of endotoxin RS per mg.

Pilocarpini hydrochloridum

Page 223

Add the following statement:

Additional requirement for Pilocarpine hydrochloride for sterile use

Complies with the "Test for sterility of non-injectable preparations" (see p. 32).

Pilocarpini nitras

Page 225

Add the following statement:

Additional requirement for Pilocarpine nitrate for sterile use

Complies with the "Test for sterility of non-injectable preparations" (see p. 32).

Procainamidi hydrochloridum

Page 235

Add the following statement and test:

Additional requirements for Procainamide hydrochloride for parenteral use

Complies with the monograph for "Parenteral preparations" (see Vol. 4, p. 36).

Bacterial endotoxins. Carry out the test as described under "Test for bacterial endotoxins" (p. 30); contains not more than 0.35 IU of endotoxin RS per mg.

Pyridostigmini bromidum

Page 245

Add the following statement and test:

Additional requirements for Pyridostigmine bromide for parenteral use

Complies with the monograph for "Parenteral preparations" (see Vol. 4, p. 36).

Bacterial endotoxins. Carry out the test as described under "Test for bacterial endotoxins" (p. 30); contains not more than 17.0 IU of endotoxin RS per mg.

Reserpinum

Page 254

Add the following statement and test:

Additional requirements for Reserpine for parenteral use

Complies with the monograph for "Parenteral preparations" (see Vol. 4, p. 36).

Bacterial endotoxins. Carry out the test as described under “Test for bacterial endotoxins” (p. 30); contains not more than 71.5 IU of endotoxin RS per mg.

Riboflavinum

Page 255

Replace the text with the following:

Assay

- The operations must be carried out in subdued light.

To about 0.075 g, accurately weighed, add 5 ml of water to ensure that the substance is completely wetted. Then add 5 ml of sodium hydroxide (~80 g/l) TS. As soon as this is completely dissolved, add 100 ml of water and 2.5 ml of glacial acetic acid R, and sufficient water to produce 1000 ml. To 10 ml of this solution, add 1 ml of sodium acetate (50 g/l) TS and sufficient water to produce 50 ml. Measure the absorbance of a 1-cm layer of the diluted solution at the maximum at about 444 nm. Calculate the amount of $C_{17}H_{20}N_4O_6$ in the substance being tested by comparison with riboflavin RS, similarly and concurrently examined.

Streptomycini sulfas

Page 259

Additional requirements for Streptomycin sulfate for sterile use

Add the following statement:

Complies with the “Test for sterility of non-injectable preparations” (see p. 32).

Undue toxicity

Delete the test.

Pyrogens

Delete the test and add the following:

Bacterial endotoxins. Carry out the test as described under “Test for bacterial endotoxins” (p. 30); contains not more than 0.25 IU of endotoxin RS per mg of streptomycin.

Sulfamethoxazolum

Page 261

Add the following statement:

Additional requirement for Sulfamethoxazole for parenteral use

Complies with the monograph for "Parenteral preparations" (see Vol. 4, p. 36).

Tetracyclini hydrochloridum

Page 269

Additional requirements for Tetracycline hydrochloride for sterile use

Add the following statement:

Complies with the "Test for sterility of non-injectable preparations" (see p. 32).

Undue toxicity

Delete the test.

Page 270

Pyrogens

Delete the test and add the following:

Bacterial endotoxins. Carry out the test as described under "Test for bacterial endotoxins" (p. 30); contains not more than 0.5IU of endotoxin RS per mg.

Trimethoprimum

Page 275

Add the following statement:

Additional requirement for Trimethoprim for parenteral use

Complies with the monograph for "Parenteral preparations" (see Vol. 4, p. 36).

List of reagents, test solutions, and volumetric solutions

Page 285

Blue tetrazolium R

Change the chemical formula to read:



Page 306

***N*-(1-Naphthyl)ethylenediamine hydrochloride/ethanol TS**

Change the text as follows:

***N*-(1-Naphthyl)ethylenediamine/ethanol TS**

Procedure. Dissolve 5 g of *N*-(1-Naphthyl)ethylenediamine hydrochloride R in a mixture of equal volumes of ethanol (~750 g/l) TS and water to produce 1000 ml.

Volume 3. Quality specifications

Amikacini sulfas

Page 20

Add the following statement and test:

Additional requirements for Amikacin sulfate for parenteral use

Complies with the monograph for "Parenteral preparations" (see Vol. 4, p. 36).

Bacterial endotoxins. Carry out the test as described under "Test for bacterial endotoxins (p. 30); contains not more than 0.33 IU of endotoxin RS per mg of amikacin.

Additional requirements for Amikacin sulfate for sterile use

Add the following statement:

Complies with the "Test for sterility of non-injectable preparations" (see p. 32).

Undue toxicity

Delete the test.

Amphotericin B

Page 27

Additional requirements for Amphotericin B for parenteral use

Add the following statement:

Complies with the monograph for "Parenteral preparations" (see Vol. 4, p. 36).

Pyrogens

Delete the test and add the following:

Bacterial endotoxins. Carry out the test as described under "Test for bacterial endotoxins" (p. 30); contains not more than 0.9 IU of endotoxin RS per mg.

Undue toxicity

Delete the test.

Bacitracinum

Page 33

Additional requirements for Bacitracin for sterile use

Add the following statement:

Complies with the "Test for sterility of non-injectable preparations" (see p. 32).

Undue toxicity

Delete the test.

Pyrogens

Delete the test and add the following:

Bacterial endotoxins. Carry out the test as described under "Test for bacterial endotoxins" (p. 30); contains not more than 0.01 IU of endotoxin RS per mg of bacitracin.

Bacitracinum zincum

Page 35

Additional requirements for Bacitracin zinc for sterile use

Add the following statement:

Complies with the "Test for sterility of non-injectable preparations" (see p. 32).

Benzathini benzylpenicillinum

Page 42

Add the following statement:

Additional requirements for Benzathine benzylpenicillin for parenteral use

Complies with the monograph for "Parenteral preparations" (see Vol. 4, p. 36).

Pyrogens

Delete the test and add the following:

Bacterial endotoxins. Carry out the test as described under "Test for bacterial endotoxins" (p. 30); contains not more than 0.01 IU of endotoxin RS per mg of benzylpenicillin.

Additional requirement for Benzathine benzylpenicillin for sterile use

Add the following statement

Complies with the "Test for sterility of non-injectable preparations" (see p. 32).

Biperidenum

Page 46

Add the following statement:

Additional requirement for Biperiden for parenteral use

Complies with the monograph for "Parenteral preparations" (see Vol. 4, p. 36).

Bleomycini hydrochloridum

Page 51

Assay B

Add the following statement:

Use stationary phase A as the packing material.

Additional requirements for Bleomycin hydrochloride for sterile use

Add the following statement:

Complies with the "Test for sterility of non-injectable preparations" (see p. 32).

Undue toxicity

Delete the test.

Pyrogens

Delete the test and add the following:

Bacterial endotoxins. Carry out the test as described under "Test for bacterial endotoxins" (p. 30); contains not more than 10.0 IU of endotoxin RS per mg of bleomycin.

Bleomycini sulfas

Page 54

Assay B

Add the following statement:

Use stationary phase A as the packing material.

Page 55

Additional requirements for Bleomycin sulfate for sterile use

Add the following statement:

Complies with the "Test for sterility of non-injectable preparations" (see p. 32).

Undue toxicity

Delete the test.

Pyrogens

Delete the test and add the following:

Bacterial endotoxins. Carry out the test as described under “Test for bacterial endotoxins” (p. 30); contains not more than 10.0 IU of endotoxin RS per mg of bleomycin.

Calcii folinas

Page 60

Assay

Add the following statement:

Use stationary phase A as the packing material.

Page 61

Add the following statement and test:

Additional requirements for Calcium folinate for parenteral use

Complies with the monograph for “Parenteral preparations” (see Vol. 4, p. 36).

Bacterial endotoxins. Carry out the test as described under “Test for bacterial endotoxins” (p. 30); contains not more than 0.5 IU of endotoxin RS per mg.

Carbidopum

Page 64

Methyldopa and 3-O-Methylcarbidopa

Use stationary phase A as the packing material.

Chlortetracyclini hydrochloridum

Page 76

Additional requirements for Chlortetracycline hydrochloride for sterile use

Add the following statement:

Complies with the "Test for sterility of non-injectable preparations" (see p. 32).

Undue toxicity

Delete the test.

Pyrogens

Delete the test and add the following:

Bacterial endotoxins. Carry out the test as described under "Test for bacterial endotoxins" (p. 30); contains not more than 1.0IU of endotoxin RS per mg.

Cimetidinum

Page 78

Related substances

Add the following statement:

Use stationary phase A as the packing material.

Add the following statement:

Additional requirement for Cimetidine for parenteral use

Complies with the monograph for "Parenteral preparations" (see Vol. 4, p. 36).

Dexamethasoni natrii phosphas

Page 94

Add the following statement and test:

Additional requirements for Dexamethasone sodium phosphate for parenteral use

Complies with the monograph for "Parenteral preparations" (see Vol. 4, p. 36).

Bacterial endotoxins. Carry out the test as described under “Test for bacterial endotoxins” (p. 30); contains not more than 31.3 IU of endotoxin RS per mg.

Dimercaprolum

Page 101

Add the following statement:

Additional requirement for Dimercaprol for parenteral use

Complies with the monograph for “Parenteral preparations” (see Vol. 4, p. 36).

Dopamini hydrochloridum

Page 105

Add the following statement and test:

Additional requirements for Dopamine hydrochloride for parenteral use

Complies with the monograph for “Parenteral preparations” (see Vol. 4, p. 36).

Bacterial endotoxins. Carry out the test as described under “Test for bacterial endotoxins” (p. 30); contains not more than 16.67 IU of endotoxin RS per mg.

Erythromycini ethylsuccinas

Page 125

Additional requirement for Erythromycin ethylsuccinate for parenteral use

Add the following statement:

Complies with the monograph for “Parenteral preparations” (see Vol. 4, p. 36).

Undue toxicity

Delete the test.

Flucytosinum

Page 135

Add the following statement:

Additional requirement for Flucytosine for parenteral use

Complies with the monograph for "Parenteral preparations" (see Vol. 4, p. 36).

Fluoresceinum natricum

Page 140

Add the following statement:

Additional requirement for Fluorescein sodium for sterile use

Complies with the "Test for sterility of non-injectable preparations" (see p. 32).

Fluorouracilum

Page 142

Add the following statement and test:

Additional requirements for Fluorouracil for parenteral use

Complies with the monograph for "Parenteral preparations" (see Vol. 4, p. 36).

Bacterial endotoxins. Carry out the test as described under "Test for bacterial endotoxins" (p. 30); contains not more than 0.33 IU of endotoxin RS per mg.

Gentamicini sulfas

Pages 146–147

Additional requirements for Gentamicin sulfate for sterile use

Add the following statement:

Complies with the "Test for sterility of non-injectable preparations" (p. 32).

Undue toxicity

Delete the test.

Pyrogens

Delete the test.

Add the following statement and test:

Additional requirements for Gentamicin sulfate for parenteral use

Complies with the monograph for "Parenteral preparations" (see Vol. 4, p. 36).

Bacterial endotoxins. Carry out the test as described under "Test for bacterial endotoxins" (p. 30); contains not more than 1.70 IU of endotoxin RS per mg of gentamicin.

Hydrocortisoni natrii succinas

Page 153

Specific optical rotation

Replace the text with the following:

Use a 10 mg/ml solution in ethanol (~750 g/l) TS and calculate with reference to the dried substance; $[\alpha]_D^{20} = +140^\circ$ to $+150^\circ$.

Hydroxocobalaminum

Page 157

Add the following statement and test:

Additional requirements for Hydroxocobalamin for parenteral use

Complies with the monograph for "Parenteral preparations" (see Vol. 4, p. 36).

Bacterial endotoxins. Carry out the test as described under "Test for bacterial endotoxins" (p. 30); contains not more than 0.4 IU of endotoxin RS per mg.

Methotrexatum

Page 179

Assay

Add the following statement:

Use stationary phase A as the packing material.

Add the following statement:

Additional requirement for Methotrexate for parenteral use

Complies with the monograph for "Parenteral preparations" (see Vol. 4, p. 36).

Methylthioninii chloridum

Page 182

Add the following statement and test:

Additional requirements for Methylthioninium chloride for parenteral use

Complies with the monograph for "Parenteral preparations" (see Vol. 4, p. 36).

Bacterial endotoxins. Carry out the test as described under "Test for bacterial endotoxins" (p. 30); contains not more than 2.5IU of endotoxin RS per mg.

Metoclopramidi hydrochloridum

Page 184

Add the following statement and test:

Additional requirements for Metoclopramide hydrochloride for parenteral use

Complies with the monograph for "Parenteral preparations" (see Vol. 4, p. 36).

Bacterial endotoxins. Carry out the test as described under "Test for bacterial endotoxins" (p. 30); contains not more than 2.5IU of endotoxin RS per mg of metoclopramide.

Naloxoni hydrochloridum

Page 189

Replace the text with the following:

Related substances. Carry out the test as described under "Thin-layer chromatography" (Vol. 1, p. 83), using silica gel R1 as the coating substance, and as the mobile phase prepare the following solution: shake 100ml of 1-butanol R with 60ml of ammonia (~17 g/l) TS, discard the lower layer, and mix 95 volumes of the upper layer with 5 volumes of methanol R. Dry the plate in a current of air. Apply separately to the plate 5µl of each of the two following solutions. For solution (A) dissolve 40mg of Naloxone hydrochloride in 2ml of water and dilute to 5ml with methanol R. For solution (B) dilute 0.5ml of solution A to 100ml with methanol R. Develop the chromatogram protected

from light. After removing the plate from the chromatographic chamber, allow it to dry in air, spray with ferric chloride/potassium ferricyanide TS, and examine the chromatogram in daylight.

Any spot obtained with solution A, other than the principal spot, is not more intense than that obtained with solution B (0.5%). Disregard any spot remaining at the point of application.

Page 190

Add the following statement and test:

Additional requirements for Naloxone hydrochloride for parenteral use

Complies with the monograph for "Parenteral preparations" (see Vol. 4, p. 36).

Bacterial endotoxins. Carry out the test as described under "Test for bacterial endotoxins" (p. 30); contains not more than 500 IU of endotoxin RS per mg.

Natrii calcii edetas

Page 192

Add the following statement and test:

Additional requirements for Sodium calcium edetate for parenteral use

Complies with the monograph for "Parenteral preparations" (see Vol. 4, p. 36).

Bacterial endotoxins. Carry out the test as described under "Test for bacterial endotoxins" (p. 30); contains not more than 0.2 IU of endotoxin RS per mg of sodium edetate.

Natrii nitris

Page 199

Add the following statement and test:

Additional requirements for Sodium nitrite for parenteral use

Complies with the monograph for "Parenteral preparations" (see Vol. 4, p. 36).

Bacterial endotoxins. Carry out the test as described under "Test for bacterial endotoxins" (p. 30); contains not more than 0.33 IU of endotoxin RS per mg.

Natrii stibogluconas

Pages 202–203

Undue toxicity

Delete the test.

Natrii thiosulfas

Page 209

Add the following statement and test:

Additional requirements for Sodium thiosulfate for parenteral use

Complies with the monograph for “Parenteral preparations” (see Vol. 4, p. 36).

Bacterial endotoxins. Carry out the test as described under “Test for bacterial endotoxins” (p. 30); contains not more than 0.03 IU of endotoxin RS per mg.

Neostigmini metilsulfas

Page 216

Add the following statement:

Additional requirement for Neostigmine metilsulfate for parenteral use

Complies with the monograph for “Parenteral preparations” (see Vol. 4, p. 36).

Nystatinum

Page 229

Undue toxicity

Delete the test.

Oxytetracyclini dihydras

Page 234

Additional requirements for Oxytetracycline dihydrate for sterile use

Add the following statement:

Complies with the "Test for sterility of non-injectable preparations" (see p. 32).

Pyrogens

Delete the test and add the following:

Bacterial endotoxins. Carry out the test as described under "Test for bacterial endotoxins" (p. 30); contains not more than 0.4IU of endotoxin RS per mg of oxytetracycline.

Oxytetracyclini hydrochloridum

Page 237

Additional requirements for Oxytetracycline hydrochloride for sterile use

Add the following statement:

Complies with the "Test for sterility of non-injectable preparations" (see p. 32).

Undue toxicity

Delete the test.

Pyrogens

Delete the test and add the following:

Bacterial endotoxins. Carry out the test as described under "Test for bacterial endotoxins" (p. 30); contains not more than 0.4IU of endotoxin RS per mg of oxytetracycline.

Pethidini hydrochloridum

Page 249

Add the following statement and test:

Additional requirements for Pethidine hydrochloride for parenteral use

Complies with the monograph for "Parenteral preparations" (see Vol. 4, p. 36).

Bacterial endotoxins. Carry out the test as described under "Test for bacterial endotoxins" (p. 30); contains not more than 2.4IU of endotoxin RS per mg.

Phytomenadionum

Page 250

Add the following statement and test:

Additional requirements for Phytomenadione for parenteral use

Complies with the monograph for "Parenteral preparations" (see Vol. 4, p. 36).

Bacterial endotoxins. Carry out the test as described under "Test for bacterial endotoxins" (p. 30); contains not more than 14.0IU of endotoxin RS per mg.

Praziquantelum

Page 253

Replace the text with the following:

Assay. Dissolve about 0.04g, accurately weighed, in sufficient ethanol (~750g/l) TS to produce 100ml. Measure the absorbance of a 1-cm layer at the maximum at about 265nm. Calculate the amount of C₁₉H₂₄N₂O₂ in the substance being tested by comparison with praziquantel RS, similarly and concurrently examined.

Procaini benzylpenicillinum

Page 260

Additional requirements for Oxytetracycline hydrochloride for sterile use

Add the following statement:

Complies with the "Test for sterility of non-injectable preparations" (see p. 32).

Pyrogens

Delete the test and add the following:

Bacterial endotoxins. Carry out the test as described under “Test for bacterial endotoxins” (p. 30); contains not more than 0.01 IU of endotoxin RS per mg of benzylpenicillin.

Promethazini hydrochloridum

Page 263

Add the following statement and test:

Additional requirements for Promethazine hydrochloride for parenteral use

Complies with the monograph for “Parenteral preparations” (see Vol. 4, p. 36).

Bacterial endotoxins. Carry out the test as described under “Test for bacterial endotoxins” (p. 30); contains not more than 5.0 IU of endotoxin RS per mg.

Quinini dihydrochloridum

Page 278

Add the following statement:

Additional requirement for Quinine dihydrochloride for parenteral use

Complies with the monograph for “Parenteral preparations” (see Vol. 4, p. 36).

Salbutamoli sulfas

Page 284

Add the following statement:

Additional requirement for Salbutamol sulfate for parenteral use

Complies with the monograph for “Parenteral preparations” (see Vol. 4, p. 36).

Spectinomycini hydrochloridum

Page 290

Undue toxicity

Delete the test.

Pyrogens

Delete the test.

Add the following statement and test:

Additional requirement for Spectinomycin hydrochloride for parenteral use

Bacterial endotoxins. Carry out the test as described under “Test for bacterial endotoxins” (p. 30); contains not more than 0.09IU of endotoxin RS per mg of spectinomycin.

Suraminum natricum

Page 309

Undue toxicity

Delete the test.

Suxamethonii chloridum

Page 311

Add the following statement and test:

Additional requirements for Suxamethonium chloride for parenteral use

Complies with the monograph for “Parenteral preparations” (see Vol. 4, p. 36).

Bacterial endotoxins. Carry out the test as described under “Test for bacterial endotoxins” (p. 30); contains not more than 2.0IU of endotoxin RS per mg.

Testosteroni enantas

Page 313

Identity test B

Carry out the test using thin-layer chromatography as described under "Related substances".

Page 314

Add the following statement and test:

Additional requirements for Testosterone enantate for parenteral use

Complies with the monograph for "Parenteral preparations" (see Vol. 4, p. 36).

Bacterial endotoxins. Carry out the test as described under "Test for bacterial endotoxins" (p. 30); contains not more than 3.5 IU of endotoxin RS per mg.

Tetracaini hydrochloridum

Page 316

Add the following test:

Additional requirement for Tetracaine hydrochloride for sterile use

Complies with the "Test for sterility of non-injectable preparations" (see p. 32).

Verapamili hydrochloridum

Page 330

Add the following statement and test:

Additional requirements for Verapamil hydrochloride for parenteral use

Complies with the monograph for "Parenteral preparations" (see Vol. 4, p. 36).

Bacterial endotoxins. Carry out the test as described under "Test for bacterial endotoxins" (p. 30); contains not more than 16.7 IU of endotoxin RS per mg.

List of reagents, test solutions, and volumetric solutions

Page 345

Clomifene citrate Z-isomer RS

See **Zuclomifene RS**.

Page 357

Neomycin B sulfate RS

Rename the substance according to the International Nonproprietary Name (INN):

Framycetin sulfate RS

Page 358

Noroxymorphone hydrochloride RS

Delete the substance.

Page 369

Add the following substance:

Zuclomifene RS. Clomifene citrate Z-isomer. International Chemical Reference Substance.

Volume 4. Tests, methods, and general requirements.
Quality specifications for pharmaceutical substances,
excipients, and dosage forms

General notices

Page 5

Footnote 1

Replace the third entry to read:

- Glass-ware – Hydrolytic resistance of the interior surfaces of glass containers
 - Methods of test, Ref. No. ISO 4802-1988 (E).

Page 8

Change the first sentence to read:

(b) Biological

The primary purpose underlying the establishment of International Biological Standards and International Biological Reference Preparations is to provide a means of ensuring uniformity throughout the world in the designation of the activity or specificity of preparations that are used in the prophylaxis, therapy, or diagnosis of human and certain animal diseases, which cannot be expressed directly in terms of chemical and physical quantities.

Tests, methods, and general requirements

Page 15

Change the first sentence in the footnote:

Good manufacturing practices for pharmaceutical products, WHO Technical Report Series, No. 823, 1992, Annex 1.

Page 21

Filtration

Change the first sentence of the third paragraph:

Usually, membranes of not greater than 0.22 µm nominal pore size should be used.

Monographs for pharmaceutical substances

Acidum iopanoicum

Page 54

Assay

Change the chemical formula to read:



Aluminii sulfas

Page 56

Colour and clarity of solution

Replace the text with the following:

A solution of 0.50 g in 10 ml of water is colourless and not more opalescent than opalescence standard TS2.

Dactinomycinum

Page 62

Assay

Add the following statement:

Use stationary phase A as the packing material.

Undue toxicity

Delete the test.

Additional requirements for Dactinomycin for parenteral use

Add the following statement:

Complies with the monograph for "Parenteral preparations" (see Vol. 4, p. 36).

Pyrogens

Delete the test and add the following:

Bacterial endotoxins. Carry out the test as described under "Test for bacterial endotoxins" (p. 30); contains not more than 100.0 IU of endotoxin RS per mg.

Iohexolum

Page 69

Identity test B

Replace the text with the following:

The absorption spectrum of a 10 µg/ml solution, when observed between 230 nm and 350 nm, exhibits a maximum at about 245 nm; the absorbance of a 1-cm layer at the maximum wavelength is about 0.36.

Page 70

Related substances

Change the concentration of solution D to:

40 µg of Iohexol per ml.

Ketamini hydrochloridum

Page 73

Add the following statement and test:

Additional requirements for Ketamine hydrochloride for parenteral use

Complies with the monograph for "Parenteral preparations" (see Vol. 4, p. 36).

Bacterial endotoxins. Carry out the test as described under "Test for bacterial endotoxins" (p. 30); contains not more than 0.4 IU of endotoxin RS per mg.

Magnesii sulfatis heptahydras

Page 74

Loss on drying

Replace the text with the following:

Dry 0.5 g at 110–120 °C for 1 hour and then at 400 °C to constant mass; it loses not less than 0.48 g/g and not more than 0.52 g/g.

Page 74

Add the following statement and test:

Additional requirements for Magnesium sulfate heptahydrate for parenteral use

Complies with the monograph for "Parenteral preparations" (See Vol. 4, p. 36).

Bacterial endotoxins. Carry out the test as described under "Test for bacterial endotoxins" (p. 30); contains not more than 0.09 IU of endotoxin RS per mg.

Medroxyprogesteroni acetat

Page 77

Add the following statement:

Additional requirement for Medroxyprogesterone acetate for parenteral use

Complies with the monograph for "Parenteral preparations" (see Vol. 4, p. 36).

Norethisteroni enantas

Page 83

Identity test B

Replace the text with the following:

The absorption spectrum of a 13.5 µg/ml solution in methanol R, when observed between 210 nm and 290 nm, exhibits a maximum at about 240 nm.

Page 84

Add the following statement:

Additional requirement for Norethisterone enantate for parenteral use

Complies with the monograph for "Parenteral preparations" (see Vol. 4, p. 36).

Propyliodonum

Page 86

Identity test A

Replace the text with the following:

The absorption spectrum of a 20 µg/ml solution in dehydrated ethanol R, when observed between 230 nm and 350 nm, exhibits 2 maxima at about 239 nm and 281 nm; the absorbances of a 1-cm layer at those wavelengths are about 0.64 and 0.52, respectively.

Page 87

Add the following statement:

Additional requirement for Propylidone for parenteral use

Complies with the monograph for "Parenteral preparations" (see Vol. 4, p. 36).

Tamoxifeni citras

Pages 89–90

Replace the text with the following:

***E*-isomer and related substances.** Carry out the test as described under “High-performance liquid chromatography” (p. 257), using a stainless steel column (20 cm × 5 mm) packed with *stationary phase A* (5 μm). As the mobile phase, use a mixture of 400 volumes of acetonitrile R and 600 volumes of water containing 0.9 g/l of sodium dihydrogen phosphate R and 4.8 g/l of *N,N*-dimethyloctylamine R adjusted to pH 3.0 with phosphoric acid (~105 g/l) TS.

Prepare the following solutions in the mobile phase: for solution (A) use 1.0 mg of Tamoxifen citrate per ml; for solution (B) use 1.0 mg of tamoxifen citrate *E*-isomer RS per ml; for solution (C) dilute 1 volume of solution A to 100 volumes with the mobile phase; and for solution (D) dilute 1 volume of solution B to 100 volumes with the mobile phase.

Operate with a flow rate of 1.0 ml per minute. As a detector use an ultraviolet spectrophotometer set at a wavelength of about 240 nm, the instrument being fitted with a low volume flow cell (10 μl).

Equilibrate the column with the mobile phase at a flow rate of 1.0 ml per minute for about 30 minutes.

Make three replicate injections of 10 μl each of solution D, adjusting the sensitivity of the system so that the height of the peak is not less than 40% of the full scale of the recorder.

Inject alternately 10 μl each of solutions A, C, and D. The test is not valid unless the peak obtained with solution D elutes prior to that for solution C, and with solution A there is baseline separation between all the peaks.

Measure the areas of the peak responses obtained in the chromatograms from solutions A, C, and D, and calculate the content of the related substances as a percentage. Calculate the content of *E*-isomer comparing the peaks obtained with solutions A and D; not more than 10 mg/g. In the chromatogram obtained with solution A, the area of any peak, other than the peak due to the *E*-isomer obtained with solution D, is not greater than half that of the peak obtained with solution C (0.5%). Furthermore, the sum of the areas is not greater than the peak obtained with solution C (1%).

Thiopentalum natricum

Page 91

Identity tests

Replace the texts for identity tests A and B with the following:

- A. Place about 0.5 g in a separatory funnel, add 10 ml of water and acidify with hydrochloric acid (~70 g/l) TS. Shake with 20 ml of ether R, separate the ether layer, wash with 10 ml of water, dry over anhydrous sodium sulfate R, and filter. Evaporate the filtrate to dryness over a water-bath and dry the residue at 100–105 °C. Carry out the examination as described under “Spectrophotometry in the infrared region” (Vol. 1, p. 40). The infrared absorption spectrum is concordant with the spectrum obtained from thiopental RS or with the *reference spectrum* of thiopental.
- B. See the test described below under “Related substances”. Apply 10 µl of each of solutions B and C to the plate and develop the chromatogram for a distance of 18 cm. The principal spot obtained with solution B corresponds in position and intensity with that obtained with solution C.

Page 92

Related substances

Replace the text with the following:

Carry out the test as described under “Thin-layer chromatography” (Vol. 1, p. 83), using silica gel R4 as the coating substance and the lower layer of a mixture of 5 volumes of ammonia (~260 g/l) TS, 15 volumes of ethanol (~750 g/l) TS, and 80 volumes of chloroform R as the mobile phase. Apply separately to the plate 20 µl of each of three solutions containing (A) 10 mg of Thiopental sodium per ml (disregard any slight residue), for solution (B) dilute 1 ml of solution A to 10 ml, for solution (C) dissolve 85 mg of thiopental RS in 10 ml of sodium hydroxide (~80 g/l) TS and dilute with sufficient water to produce 100 ml, and for solution (D) dilute 0.5 ml of solution A to 100 ml. After removing the plate from the chromatographic chamber, examine the chromatogram immediately in ultraviolet light.

Any spot obtained with solution A, other than the principal spot, is not more intense than that obtained with solution D (0.5%). Disregard any spot at the point of application.

Timololi maleas

Page 94

Identity test B

Replace the text with the following:

The absorption spectrum of a 25 µg/ml solution in sulfuric acid (0.05 mol/l) VS, when observed between 230 nm and 350 nm, exhibits a maximum at about 295 nm; the absorbance of a 1-cm layer at this wavelength is about 0.52.

Specific optical rotation

Replace the text with the following:

Use a 50 mg/ml solution in hydrochloric acid (1 mol/l) VS; $[\alpha]_{\text{D}}^{20} = -11.7^{\circ}$ to -12.5° .

Add the following test:

Additional requirement for Timolol maleate for sterile use

Complies with the "Test for sterility of non-injectable preparations" (see p. 32).

Vinblastini sulfas

Page 96

Loss on drying

Replace the text with the following:

Dry at 60 °C under reduced pressure (not exceeding 0.6 kPa or 5 mm of mercury) for 16 hours; it loses not more than 170 mg/g.

Acidum amidotrizoicum

Page 100

Additional requirement for Amidotrizoic acid for parenteral use

Add the following statement:

Complies with the monograph for "Parenteral preparations" (see Vol. 4, p. 36).

Acidum iotroxicum

Page 102

Additional requirement for Iotroxic acid for parenteral use

Add the following statement:

Complies with the monograph for "Parenteral preparations" (see Vol. 4, p. 36).

Add the following statement:

Additional requirement for Iotroxic acid for sterile use

Complies with the "Test for sterility of non-injectable preparations" (see p. 32).

Megluminum

Page 104

Additional requirement for Meglumine for parenteral use

Add the following statement:

Complies with the monograph for "Parenteral preparations" (see Vol. 4, p. 36).

Add the following statement:

Additional requirement for Meglumine for sterile use

Complies with the "Test for sterility of non-injectable preparations" (see p. 32).

Monographs for excipients

Acidum citrium

Page 110

Change the title to read:

Acidum citricum

Acidum lacticum

Page 117

Methanol and methyl esters

Replace the last sentence with the following:

The solution is not more intensely coloured than a reference solution prepared similarly, but using instead of the distillate 1.0 ml of a solution containing 100 µg of methanol R and 0.1 ml of ethanol (~750 g/l) TS per ml (500 µg/g of methanol).

Page 118

Add the following statement and test:

Additional requirements for Lactic acid for parenteral use

Complies with the monograph for "Parenteral preparations" (see Vol. 4, p. 36).

Bacterial endotoxins. Carry out the test as described under "Test for bacterial endotoxins" (p. 30); contains not more than 83.3 IU of endotoxin RS per mg.

Amyla

Page 130

Oxidizing matter

Replace the first sentence with the following:

Shake 5 g with a mixture of 10 ml of water and 1.2 ml of acetic acid (~300 g/l) TS until a suspension of homogenous appearance is obtained.

Page 131

Sulfur dioxide

Replace the first sentence with the following:

Mix 20 g with 200 ml of water until a suspension of homogenous appearance is obtained. Filter.

Aqua purificata

Page 132

Add the following statement:

Additional requirement for Purified water for sterile use

Complies with the "Test for sterility of non-injectable preparations" (see p. 32).

Aqua pro injectione

Page 133

Requirements

Add the following statement:

Complies with the monograph for "Parenteral preparations" (see Vol. 4, p. 36).

Page 134

Pyrogens

Delete the test and add the following:

Bacterial endotoxins. Carry out the test as described under "Test for bacterial endotoxins" (p. 30); contains not more than 0.25 IU of endotoxin RS per ml.

Aqua sterilisata pro injectione

Page 135

Pyrogens

Delete the test and add the following:

Bacterial endotoxins. Carry out the test as described under "Test for bacterial endotoxins" (p. 30); contains not more than 0.25 IU of endotoxin RS per ml.

Benzyllis hydroxybenzoas

Page 139

Identity test A

Replace the text with the following:

The absorption spectrum of a 10 µg/ml solution in ethanol (~750 g/l) TS, when observed between 230 nm and 350 nm, exhibits a maximum at about 260 nm; the absorbance of a 1-cm layer at this wavelength is about 0.76.

Butylhydroxyanisolum

Page 141

Hydroquinone

Replace the second sentence to read:

Apply separately to the plate 3 μ l of each of two solutions in ether R containing (A) 50 mg of Butylated hydroxyanisole per ml, and (B) 0.10 mg of hydroquinone R per ml.

3-*tert*-Butyl-4-methoxyphenol

Replace the first sentence of the second paragraph:

The blue-violet spot at $R_f \sim 35$ obtained with solution A is not more intense than the principal spot obtained with solution B.

Carbomerum

Page 151

Composition

Replace the text with the following:

Carbomer is a synthetic high molecular mass polymer of allyl acid copolymerized with polysucrose.

Lactosum

Page 189

Additional information

Replace the text with the following:

Attention should be paid to the microbiological purity, since Lactose is of natural origin.

Polyvidonum

Pages 204–206

Change the Latin name to:

Povidonum.

Throughout the text change the name of the substance to:

Povidone.

Saccharinum natricum

Pages 212–213

Related substances

On page 213 replace from the sentence starting on the tenth line to the end of the paragraph with the following:

For solutions (B) dissolve 50 µg of toluene-2-sulfonamide RS per ml of acetone R, (C) 5 mg of Saccharin sodium per ml of methanol R, and (D) 50 µg of 4-sulfamoylbenzoic acid R per ml of acetone R. After removing the plate from the chromatographic chamber, dry in a current of warm air, heat at 105 °C for 5 minutes, and spray the hot plate with sodium hypochlorite TS1. Dry in a current of cold air until a sprayed area of the plate below the line of application gives at most a faint blue colour with 0.05 ml of a solution of 5 mg of potassium iodide R in 1 ml of starch TS containing 1% glacial acetic acid R. Avoid prolonged exposure to cold air. Spray the plate again with the same mixture. Examine the chromatogram in daylight.

Monographs for dosage forms

Sales perorales ad rehydratationem

Page 221

Citrates

Replace the first sentence with the following:

Disperse about 2.8 g of ORS, accurately weighed, in 80 ml of glacial acetic acid R1, heat to about 50 °C, cool, dilute to 100 ml with glacial acetic acid R1, and allow to stand for 10 minutes.

Ampicillini capsulae

Page 222

Identity test A

Replace the preparation of solution A on lines 5–8 with the following:

For solution (A) shake a quantity of the contents of the capsules equivalent to 50 mg of Ampicillin with 10 ml of a mixture of 4 volumes of acetone R and 1 volume of hydrochloric acid (0.1 mol/l) VS, filter, and use the clear filtrate.

Amphotericini B pulvis ad injectionem

Page 275

Undue toxicity

Delete the text.

Pyrogens

Delete the test and add the following:

Bacterial endotoxins. Carry out the test as described under “Test for bacterial endotoxins” (p. 30); contains not more than 1.0 IU of endotoxin RS per mg.

Ampicillini natrici pulvis ad injectionem

Page 278

Pyrogens

Delete the test and add the following:

Bacterial endotoxins. Carry out the test as described under “Test for bacterial endotoxins” (p. 30); contains not more than 0.15 IU of endotoxin RS per mg of ampicillin.

Benzylpenicillini kalici pulvis ad injectionem

Page 278

Storage

Replace the second sentence with the following:

Unless otherwise recommended by the manufacturer, the reconstituted solution should be used within 24 hours when stored at a temperature not exceeding 20 °C or within 7 days (14 days if a buffering agent is present) when stored at a temperature between 2 and 8 °C.

Page 280

Pyrogens

Delete the test and add the following:

Bacterial endotoxins. Carry out the test as described under “Test for bacterial endotoxins” (p. 30); contains not more than 0.01 IU of endotoxin RS per mg of benzylpenicillin.

Chloroquini phosphatis compressi

Page 229

Additional information

Replace the text with the following:

Strength in the current WHO Model list of essential drugs: 100 mg, 150 mg.

Chloroquini sulfatis compressi

Page 230

Additional information

Replace the text with the following:

Strength in the current WHO Model list of essential drugs: 100 mg, 150 mg.

Cloxacillini natrici pulvis ad injectionem

Page 282

Pyrogens

Delete the test and add the following:

Bacterial endotoxins. Carry out the test as described under “Test for bacterial endotoxins” (p. 30); contains not more than 0.40 IU of endotoxin RS per mg of cloxacillin.

Mebendazoli compressi

Pages 243–244

Related substances

Replace the preparation of the test solutions A, B, and C starting on the last line of page 243:

Apply separately to the plate 10 µl of each of the following four solutions. For solution (A) shake a quantity of the powdered tablets equivalent to 50 mg of Mebendazole with a mixture of 1 ml of anhydrous formic acid R and 9 ml of chloroform R, filter, and use the clear filtrate. For solution (B) dilute 5 ml of solution A to 10 ml using the same mixture of solvents, and for solution (C) dilute 0.5 ml of solution A to 10 ml using the same mixture of solvents.

Paracetamoli compressi

Page 252

Related substances

Replace the last sentence on the page with the following:

The test is valid only if the chromatogram obtained with solution E shows two clearly separated spots.

Prednisoloni et natrii phosphatis injectio

Page 271

Assay

Replace the last sentence with the following:

Calculate the content of $C_{21}H_{26}O_5$ in the injection being examined by comparison with the absorbances obtained and the exact strength of the solution of prednisolone sodium phosphate RS, using 419 as the $A_{1\text{cm}}^{1\%}$ at the maximum at 247 nm.

Prednisoloni et natrii succinatis pulvis ad injectionem

Page 286

Add the following text:

Bacterial endotoxins. Carry out the test as described under "Test for bacterial endotoxins" (p. 30); contains not more than 5.8 IU of endotoxin RS per mg of prednisolone.

Procaini benzylpenicillini pulvis ad injectionem

Page 287

Requirements

Replace the text with the following:

The powder for injections and the reconstituted preparation for injections comply with the monograph for "Parenteral preparations" (see Vol. 4, page 36).

The container of Procaine benzylpenicillin powder for injections contains not less than **90.0%** and not more than **110.0%** of the amount of total penicillins calculated as $C_{16}H_{18}N_2O_4S$, $C_{13}H_{20}N_2O_2$ and not less than **36.0%** and not more than **44.0%** of $C_{13}H_{20}N_2O_2$ both stated on the label.

Page 288

Total penicillins

Replace the first two sentences with the following:

Suspend a quantity of the powder for injections equivalent to about 0.045 g of Procaine benzylpenicillin, accurately weighed, in sufficient water to produce 1000 ml. Transfer two 2-ml aliquots of this suspension into separate stoppered tubes.

Page 289

Pyrogens

Delete the test and add the following:

Bacterial endotoxins. Carry out the test as described under “Test for bacterial endotoxins” (p. 30); contains not more than 0.01 IU of endotoxin RS per mg of benzylpenicillin.

Streptomycini sulfatis pulvis ad injectionem

Pages 289–290

Identity test A

On page 290 replace the sentence starting on the ninth line with the following:

For solution (C) dissolve 1 mg of kanamycin monosulfate RS and 1 mg of framycetin sulfate RS in 1 ml of solution B.

Page 291

Undue toxicity

Delete the text

Pyrogens

Delete the test and add the following:

Bacterial endotoxins. Carry out the test as described under “Test for bacterial endotoxins” (p. 30); contains not more than 0.25 IU of endotoxin RS per mg of streptomycin.

List of reagents, test solutions, and volumetric solutions

Page 302

Neomycin sulfate RS

Delete the substance.

Page 303

Nitrophenanthroline R

Delete the text under "Procedure".

Page 308

Tamoxifen citrate impurity standard RS

Replace the substance with the following:

Tamoxifen citrate *E*-isomer RS. International Chemical Reference Substance.

Thiopental sodium RS

Replace the substance with the following:

Thiopental RS. International Chemical Reference Substance.

Supplementary information

Annotated references

1. Procedure for the selection of recommended international nonproprietary names for pharmaceutical substances and General principles for guidance in devising international nonproprietary names for pharmaceutical substances. In: *International nonproprietary names (INN) for pharmaceutical substances. Cumulative list No. 10*. Geneva, World Health Organization, 2002, pp. ix–xii, available on CD-ROM.

This information is also accessible on the Internet at <http://www.who.int/medicines/>

These two texts are based on World Health Assembly resolution WHA3.11. The procedure for the selection of recommended international nonproprietary names for pharmaceutical substances, and the general principles for selecting international nonproprietary names for pharmaceutical substances, have been updated regularly since the INN programme began in 1950.

2. Guidelines for the graphic representation of chemical formulae. In: *WHO Expert Committee on Specifications for Pharmaceutical Preparations. Thirty-fourth report*. Geneva, World Health Organization, 1996, Annex 1 (WHO Technical Report Series, No. 863, pp. 16–49).

These guidelines are also available in *The graphic representation of chemical formulae in the publications of international nonproprietary names (INN) for pharmaceutical substances*. Geneva, World Health Organization, 1995 (document WHO/PHARM/95.579).

These unique guidelines are intended to help scientists to portray chemical names and structures correctly and unambiguously in pharmacopoeias and other compendia. For details of chemical nomenclature conventions, readers are referred to the recommendations of the International Union of Pure and Applied Chemistry.¹

The guidelines should be followed as closely as possible, although it should be noted that unwavering adherence to these principles is not always practicable. Therefore, they may be adapted, with certain exceptions, where necessary to produce accurately drawn structural formulae. Details of the formulae, such as bond lengths, the position of subscripts and superscripts,

¹ International Union of Pure and Applied Chemistry, Organic Chemistry Division, Commission on the Nomenclature of Organic Chemistry. *Nomenclature of organic chemistry, sections, A, B, C, D, E, F, and H*, 4th ed. Oxford, Pergamon, 1979.

Leigh GJ, ed. *Nomenclature of inorganic chemistry: recommendations 1990*. Oxford, Blackwell Scientific, 1990.

and the closeness of apposition of the individual atomic symbols, will depend on the drawing method used, whether computer-based or manual.

The guidelines cover acyclic, cyclic, and ionic structures, isotopically modified and coordination compounds, stereochemistry, carbohydrates, steroids, terpenoids, prostanoids, alkaloids, antibiotics, polypeptides, and polymers.

List of available International Chemical Reference Substances¹

International Chemical Reference Substances (ICRS) are established on the advice of the WHO Expert Committee on Specifications for Pharmaceutical Preparations. They are supplied primarily for use in physical and chemical tests and assays described in the specifications for quality control of drugs published in *The International Pharmacopoeia* or proposed in draft monographs. The ICRS are mainly intended to be used as primary standards to calibrate secondary standards.

Directions for use, and analytical data required for the use described in the relevant specifications of *The International Pharmacopoeia*, are given in the certificates enclosed with the substances when distributed. More detailed analytical reports on the substances may be obtained from the WHO Collaborating Centre for Chemical Reference Substances.

ICRS may also be used in tests and assays not described in *The International Pharmacopoeia*. However, the responsibility for assessing the suitability of the substances then rests with the user or with the pharmacopoeia commission or other authority that has prescribed this use.

It is generally recommended that the substances should be stored protected from light and moisture and preferably at a temperature of about 5 °C. When special storage conditions are required, this is stated on the label or in the accompanying leaflet. It is recommended that the user purchase only an amount sufficient for immediate use.

The stability of the ICRS kept at the Collaborating Centre is monitored by regular re-examination, and any material that has deteriorated is replaced by new batches as necessary. Lists giving control numbers for the current batches are issued in the annual reports from the Centre and new yearly lists may be obtained on request.

Orders for the ICRS should be sent to:

WHO Collaborating Centre for Chemical Reference Substances
Apoteket AB
Produktion & Laboratorier Centrallaboratoriet, ACL
Prismavägen 2
S-141 75 Kungens Kurva
Sweden
(Fax: +46 8 740 6040; email: who.apl@apoteket.se)

¹ As updated at the thirty-seventh meeting of the WHO Expert Committee on Specifications for Pharmaceutical Preparations, 22–26 October 2001.

The International Pharmacopoeia

The ICRS are supplied only in the standard packages indicated in the following list:

<i>Reference substance</i>	<i>Package size</i>	<i>Control number</i>
<i>p</i> -acetamidobenzalazine	25 mg	290042
acetazolamide	100 mg	186128
allopurinol	100 mg	287049
amidotrizoic acid	100 mg	196205
2-amino-5-nitrothiazole	25 mg	186131
3-aminopyrazole-4-carboxamide hemisulfate	100 mg	172050
3-amino-2,4,6-triiodobenzoic acid	100 mg	196206
amitriptyline hydrochloride	100 mg	181101
amodiaquine hydrochloride	200 mg	192160
amphotericin B	400 mg	191153
ampicillin (anhydrous)	200 mg	390001
ampicillin sodium	200 mg	388002
ampicillin trihydrate	200 mg	274003
anhydrotetracycline hydrochloride	25 mg	180096
atropine sulfate	100 mg	183111
azathioprine	100 mg	172060
bacitracin zinc	200 mg	192174
beclometasone dipropionate	200 mg	192175
bendazol hydrochloride	100 mg	173066
benzobarbital	100 mg	172051
benzylamine sulfate	100 mg	172052
benzylpenicillin potassium	200 mg	180099
benzylpenicillin sodium	200 mg	280047
bephenium hydroxynaphthoate	100 mg	183112
betamethasone	100 mg	183113
betamethasone sodium phosphate	100 mg	196203
betamethasone valerate	100 mg	190145
betanidine sulfate	100 mg	172053
bupivacaine hydrochloride	100 mg	289054
caffeine	100 mg	181102
calcium folinate (leucovorin calcium)	100 mg	194188
captopril	100 mg	197214
captopril disulfide	25 mg	198216
carbamazepine	100 mg	189143
carbenicillin monosodium	200 mg	383043
chloramphenicol	200 mg	486004
chloramphenicol palmitate	1 g	286072
chloramphenicol palmitate (polymorph A)	200 mg	175073
5-chloro-2-methylaminobenzophenone	100 mg	172061

Supplementary information

<i>Reference substance</i>	<i>Package size</i>	<i>Control number</i>
chloroquine sulfate	200 mg	195201
2-(4-chloro-3-sulfamoylbenzoyl)benzoic acid	50 mg	181106
chlorphenamine hydrogen maleate	100 mg	182109
chlorpromazine hydrochloride	100 mg	178080
chlortalidone	100 mg	183114
chlortetracycline hydrochloride	200 mg	187138
cimetidine	100 mg	190150
ciprofloxacin hydrochloride	400 mg	197210
ciprofloxacin by-compound A	20 mg	198220
ciprofloxacin desfluoro-compound	20 mg	198219
ciprofloxacin ethylenediamine-compound	20 mg	198218
cisplatin	100 mg	197207
clomifene citrate	100 mg	187136
clomifene citrate <i>Z</i> -isomer <i>see</i> zuclomifene		
cloxacillin sodium	200 mg	274005
colecalfiferol (vitamin D ₃)	500 mg	190146
cortisone acetate	100 mg	167006
dapsone	100 mg	183115
desoxycortone acetate	100 mg	167007
dexamethasone	100 mg	388008
dexamethasone acetate	100 mg	288009
dexamethasone phosphoric acid	100 mg	192161
dexamethasone sodium phosphate	100 mg	192158
diazepam	100 mg	172062
diazoxide	100 mg	181103
dicloxacillin sodium	200 mg	174071
dicolinium iodide	100 mg	172055
dicoumarol	100 mg	178077
diethylcarbamazine dihydrogen citrate	100 mg	181100
digitoxin	100 mg	277010
digoxin	100 mg	587011
dopamine hydrochloride	100 mg	192159
doxorubicin hydrochloride	100 mg	196202
emetine hydrochloride	100 mg	187134
4-epianhydrotetracycline hydrochloride	25 mg	288097
4-epitetracycline hydrochloride	25 mg	293098
ergocalciferol (vitamin D ₂)	500 mg	190147
ergometrine hydrogen maleate	50 mg	277012
ergotamine tartrate	50 mg	385013
erythromycin	250 mg	191154
erythromycin B	150 mg	194186

The International Pharmacopoeia

<i>Reference substance</i>	<i>Package size</i>	<i>Control number</i>
erythromycin C	25 mg	194187
estradiol benzoate	100 mg	167014
estrone	100 mg	279015
etacrynic acid	100 mg	281056
ethambutol hydrochloride	100 mg	179081
ethinylestradiol	100 mg	301016
ethisterone	100 mg	167017
ethosuximide	100 mg	179088
etocarlide	100 mg	172057
flucloxacillin sodium	200 mg	195194
flucytosine	100 mg	184121
fludrocortisone acetate	200 mg	195199
fluoroqui-nolonic acid	20 mg	198217
fluorouracil	100 mg	184122
fluphenazine decanoate dihydrochloride	100 mg	182107
fluphenazine enantate dihydrochloride	100 mg	182108
fluphenazine hydrochloride	100 mg	176076
folic acid	100 mg	388019
3-formylrifamycin	200 mg	190149
framycetin sulfate (neomycin B sulfate)	200 mg	193178
furosemide	100 mg	171044
gentamicin sulfate	100 mg	194183
griseofulvin	200 mg	280040
haloperidol	100 mg	172063
hydrochlorothiazide	100 mg	179087
hydrocortisone	100 mg	283020
hydrocortisone acetate	100 mg	280021
hydrocortisone sodium succinate	200 mg	194184
(-)-3-(4-hydroxy-3-methoxyphenyl)-2-hydrazino-2-methylalanine (3-O-methylcarbidopa)	25 mg	193180
(-)-3-(4-hydroxy-3-methoxyphenyl)-2-methylalanine (3-O-methylmethyldopa)	25 mg	179085
ibuprofen	100 mg	183117
imipramine hydrochloride	100 mg	172064
indometacin	100 mg	178078
<i>o</i> -iodohippuric acid	100 mg	171045
isoniazid	100 mg	185124
kanamycin monosulfate	12 mg	197211

Supplementary information

<i>Reference substance</i>	<i>Package size</i>	<i>Control number</i>
lanatoside C	100 mg	281022
levodopa	100 mg	295065
levonorgestrel	200 mg	194182
levothyroxine sodium	100 mg	189144
lidocaine	100 mg	181104
lidocaine hydrochloride	100 mg	181105
liothyronine sodium	50 mg	193179
loperamide hydrochloride	100 mg	194185
mebendazole	200 mg	195195
melting point reference substances		
azobenzene (69 °C)	1 g	192168
vanillin (83 °C)	1 g	299169
benzil (96 °C)	4 g	294170
acetanilide (116 °C)	1 g	297171
phenacetin (136 °C)	1 g	297172
benzanilide (165 °C)	4 g	192173
sulfanilamide (166 °C)	1 g	192162
sulfapyridine (193 °C)	4 g	192163
dicyanodiamide (210 °C)	1 g	192164
saccharin (229 °C)	1 g	192165
caffeine (237 °C)	1 g	299166
phenolphthalein (263 °C)	1 g	299167
metazide	100 mg	172058
methaqualone	100 mg	173069
methotrexate	100 mg	194193
methyl dopa	100 mg	179084
methyltestosterone	100 mg	167023
meticillin sodium	200 mg	274024
metronidazole	100 mg	183118
nafcillin sodium	200 mg	272025
neamine hydrochloride (neomycin A hydrochloride)	0.5 mg	193177
neomycin B sulfate <i>see</i> framycetin sulfate		
neostigmine metilsulfate	100 mg	187135
nicotinamide	100 mg	200090
nicotinic acid	100 mg	179091
nifurtimox	100 mg	194189
niridazole	200 mg	186129
niridazole-chlorethylcarboxamide	25 mg	186130
norethisterone	100 mg	186132
norethisterone acetate	100 mg	185123
nystatin	200 mg	300152

The International Pharmacopoeia

<i>Reference substance</i>	<i>Package size</i>	<i>Control number</i>
oubain	100 mg	283026
oxacillin sodium	200 mg	382027
oxytetracycline dihydrate	200 mg	189142
oxytetracycline hydrochloride	200 mg	189141
papaverine hydrochloride	100 mg	185127
paracetamol	100 mg	195198
paromomycin sulfate	75 mg	195197
pheneticillin potassium	200 mg	167028
phenoxymethylpenicillin	200 mg	179082
phenoxymethylpenicillin calcium	200 mg	179083
phenoxymethylpenicillin potassium	200 mg	176075
phenytoin	100 mg	179089
piperazine adipate	100 mg	197212
piperazine citrate	100 mg	197213
praziquantel	100 mg	194191
prednisolone	100 mg	389029
prednisolone acetate	100 mg	289030
prednisolone hemisuccinate	200 mg	195196
prednisolone sodium phosphate	200 mg	194190
prednisone	100 mg	167031
prednisone acetate	100 mg	169032
probenecid	100 mg	192156
procaine hydrochloride	100 mg	183119
procarbazine hydrochloride	100 mg	184120
progesterone	100 mg	167033
propicillin potassium	200 mg	274034
propranolol hydrochloride	100 mg	187139
propylthiouracil	100 mg	185126
pyrantel embonate (pyrantel pamoate)	500 mg	192157
pyridostigmine bromide	100 mg	182110
reserpine	100 mg	186133
retinol acetate (solution)	5 capsules ¹	898038
riboflavin	250 mg	382035
rifampicin	200 mg	191151
rifampicin quinone	200 mg	190148
sodium amidotrizoate	100 mg	198221
sodium cromoglicate	100 mg	188140
spectinomycin hydrochloride	200 mg	193176
streptomycin sulfate	100 mg	197215

¹ Each containing about 8 mg in 230 mg of oil.

Supplementary information

<i>Reference substance</i>	<i>Package size</i>	<i>Control number</i>
sulfacetamide	100 mg	196200
sulfamethoxazole	100 mg	179092
sulfamethoxypyridazine	100 mg	178079
sulfanilamide	100 mg	179094
sulfasalazine	100 mg	191155
tamoxifen citrate	100 mg	196208
tamoxifen citrate <i>E</i> -isomer	10 mg	196209
testosterone enantate	200 mg	194192
testosterone propionate	100 mg	167036
tetracycline hydrochloride	200 mg	180095
thioacetazone	100 mg	171046
4,4'-thiodianiline	50 mg	183116
thyroxine sodium <i>see</i> levothyroxine sodium		
tolbutamide	100 mg	179086
tolnaftate	100 mg	176074
toluene-2-sulfonamide	100 mg	196204
trimethadione	200 mg	185125
trimethoprim	100 mg	179093
trimethylguanidine sulfate	100 mg	172059
vincristine sulfate	9.7 mg/vial	193181
vitamin A acetate (solution) <i>see</i> retinol acetate (solution)		
warfarin	100 mg	168041
zuclomifene	50 mg	187137

List of available International Infrared Reference Spectra¹

International Infrared Reference Spectra are established on the advice of the WHO Expert Committee on Specifications for Pharmaceutical Preparations. Full-scale reproductions of spectra produced from authenticated material on a suitable instrument are supplied for use in identification tests described in the specifications for quality control of drugs, published in *The International Pharmacopoeia* or proposed in draft monographs.

Precise instructions for the preparation of spectra are given on the label of each reference spectrum. All International Infrared Reference Spectra are distributed together with a document giving further details on the use of such spectra, entitled "General recommendations for the preparation and use of infrared spectra in pharmaceutical analysis".²

Orders for International Infrared Reference Spectra should be sent to:

WHO Collaborating Centre for Chemical Reference Substances
Apoteket AB
Produktion & Laboratorier Centrallaboratoriet, ACL
Prismavägen 2
S-141 75 Kungens Kurva
Sweden
(Fax: +46 8 740 6040; email who.apl@apoteket.se)

The following International Infrared Reference Spectra are currently available from the Centre:

aceclidine salicylate	caffeine (anhydrous)
acetazolamide	calcium folinate
allopurinol	carbidopa
amiloride hydrochloride	chlorphenamine hydrogen maleate
amitriptyline hydrochloride	clofazimine
ampicillin trihydrate	cloxacillin sodium
	colchicine
beclometasone dipropionate	cytarabine
benzylpenicillin potassium	
biperiden	dexamethasone
biperiden hydrochloride	dexamethasone acetate, mono-
bupivacaine hydrochloride	hydrate

¹ As updated at the thirty-seventh meeting of the WHO Expert Committee on Specifications for Pharmaceutical Preparations, 22–26 October 2001.

² *WHO Expert Committee on Specifications for Pharmaceutical Preparations. Thirty-fourth report.* Geneva, World Health Organization, 1996, Annex 4 (WHO Technical Report Series, No. 863).

dextromethorphan hydrobromide
diazepam
dicolinium iodide
dicoumarol
diethylcarbamazine dihydrogen
citrate
diphenoxylate hydrochloride

erythromycin ethylsuccinate
erythromycin stearate
etacrynic acid
ethionamide
ethosuximide

furosemide

gallamine triethiodide
glibenclamide

haloperidol
hydrochlorothiazide

ibuprofen
imipramine hydrochloride
indometacin
isoniazid

lidocaine
lidocaine hydrochloride
lindane

metronidazole
miconazole nitrate

niclosamide
nicotinamide
noscapine

oxamniquine

papaverine hydrochloride
phenobarbital
phenoxymethylpenicillin calcium
phenytoin
primaquine phosphate
propylthiouracil
protionamide
pyrimethamine

salbutamol
salbutamol sulfate
sulfadimidine
sulfadoxine
sulfamethoxazole
sulfamethoxyipyridazine

tiabendazole
trihexyphenidyl hydrochloride
trimethoprim

valproic acid
verapamil hydrochloride

General guidelines for the establishment, maintenance, and distribution of chemical reference substances

Introduction	329
Part A. Primary chemical reference substances	330
1. Assessment of need for the establishment of chemical reference substances	330
2. Obtaining source material	331
3. Evaluation of chemical reference substances	332
3.1 Use in identification tests	332
3.2 Use in purity tests	332
3.3 Use in assays	333
3.4 Use in the calibration of an instrument	333
4. Chemical and physical methods used in evaluating chemical reference substances	333
4.1 Methods used to verify the identity of chemical reference substances	334
4.2 Methods used to determine the purity of chemical reference substances	334
4.2.1 Separation techniques	334
Chromatographic methods	334
Capillary electrophoresis	335
4.2.2 Methods based on intrinsic thermodynamic properties	335
Differential scanning calorimetry	335
Phase solubility analysis	336
4.2.3 Other methods	336
Spectrophotometric methods	336
Titrimetric methods	336
Optical rotation methods	336
Determination of water and organic volatiles	336
5. Assignment of content	337
6. Handling and distribution of chemical reference substances	337
6.1 Packaging operations	337
6.2 Storage	338
6.3 Stability	338
6.4 Information to be supplied with chemical reference substances	339
6.5 Distribution and supply	340
6.6 Period of use	340
Part B. Secondary chemical reference substances	341
References	341

Introduction

In 1975, the WHO Expert Committee on Specifications for Pharmaceutical Preparations recommended “General guidelines for the establishment, maintenance and distribution of chemical reference substances” (1).¹ At that time these general guidelines were aimed at fostering greater collaboration and harmonization among various national and regional authorities responsible for collections of chemical reference substances. This aim is still relevant. The guidelines were initially drawn up for particular use by the WHO Collaborating Centre for Chemical Reference Substances in Sweden, which provides International Chemical Reference Substances (ICRS). These substances are primarily intended for use with pharmacopoeial monographs included in *The International Pharmacopoeia* (2).

It became evident that in order to meet particular national or regional pharmacopoeial requirements, it was necessary to establish chemical reference substances external to the WHO Collaborating Centre for Chemical Reference Substances. Another difficulty was to ensure prompt dispatch of the substances. Since the meticulous work of the WHO Collaborating Centre establishing the international collection would have to be duplicated in local or regional laboratories, guidelines were necessary to ensure the integrity of national or regional collections. In order to clarify the need for national and regional collections, the 1975 guidelines were reviewed and modified in 1982 (3). In view of refinements in pharmaceutical and analytical methods since then, the present revision was considered essential.

The purpose of having chemical reference substances is to achieve accuracy and reproducibility of the analytical results required by pharmacopoeial testing and pharmaceutical control in general. These substances are normally prepared and issued by the regional/national pharmacopoeial commission or the regional/national quality control laboratory on behalf of the drug regulatory authority. In the context of these guidelines, the general use of a chemical reference substance should be considered an integral part of a compliance-oriented monograph or test procedure used to demonstrate the identity, purity and content of pharmaceutical substances and preparations.

The establishment of chemical reference substances should be based on reports in which the results of analytical testing have been evaluated. These reports should subsequently be approved and adopted by a certifying body, normally the relevant pharmacopoeial committee or the drug regulatory authority. Such establishment can be on an international, national or regional basis. Each substance is generally established for a specific analytical purpose, defined by the issuing body. Its use for any other purpose becomes the responsibility of the user and a suitable caution is included in the information sheet accompanying a reference substance. The present guidelines are concerned

¹ The term *chemical reference substances*, as used in this text, refers to an authenticated uniform material that is intended for use in specified chemical and physical tests, in which its properties are compared with the properties of a product under examination, and which possesses a degree of purity adequate for its intended use.

with both primary and secondary chemical reference substances as defined below.

The preparation of a chemical reference substance should comply with the requirements for quality assurance systems, including principles of good manufacturing practices (GMP) and good control laboratory practices (4–6).

Adequate training programmes are also required. Both the WHO Collaborating Centre and other laboratories concerned with the evaluation and establishment of chemical reference substances give assistance in training, subject to the availability of resources.

Primary chemical reference substance

A designated primary chemical reference substance is one that is widely acknowledged to have the appropriate qualities within a specified context, and whose value is accepted without requiring comparison to another chemical substance.

Secondary chemical reference substance

A secondary chemical reference substance is a substance whose characteristics are assigned and/or calibrated by comparison with a primary chemical reference substance. The extent of characterization and testing of a secondary chemical reference substance may be less than for a primary chemical reference substance. This definition may apply *inter alia* to some substances termed “working standards”.

Part A. Primary chemical reference substances

1. Assessment of need for the establishment of chemical reference substances

The production, validation, maintenance and distribution of chemical reference substances is a costly and time-consuming undertaking. It is therefore of great importance to determine critically whether a need for a given substance exists. Requests for new chemical reference substances usually arise when a particular approach to developing a specification for a new substance or product has been adopted. Methods may have been proposed in a specification that require the establishment of a chemical reference substance for use as a comparative standard. Therefore, the first matter that should be assessed is whether an alternative, equally satisfactory, procedure could be adopted that does not require a comparative standard.

Analytical procedures currently used in specifications for pharmaceutical substances and products that may require a chemical reference substance are:

- (a) infrared (IR) spectrophotometry, whether for identification or quantitative purposes;
- (b) quantitative methods based on ultraviolet (UV) absorption spectrophotometry;

- (c) quantitative methods based on the development of a colour and the measurement of its intensity, whether by instrumental or visual comparison;
- (d) methods based on chromatographic separation for identification or quantitative purposes;
- (e) quantitative methods (including automated methods) based on other separation techniques that depend on partition of the substance to be determined between solvent phases, where the precise efficiency of the extraction procedure might depend upon ambient conditions that vary from time to time and from laboratory to laboratory;
- (f) quantitative methods, often titrimetric but sometimes gravimetric, that are based on non-stoichiometric relationships;
- (g) assay methods based on measurement of optical rotation; and
- (h) methods that might require a chemical reference substance consisting of a fixed ratio of known components (for example, *cis/trans* isomers, spiked samples).

2. Obtaining source material

Source material of satisfactory quality can be selected from a batch (lot) of the substance originating from the normal production process, if the purity is acceptable. Further purification techniques may be needed to render the material acceptable for use as a chemical reference substance.

The purity requirements for a chemical reference substance depend upon its intended use. A chemical reference substance proposed for an identification test does not require meticulous purification, since the presence of a small percentage of impurities in the substance often has no noticeable effect on the test.

On the other hand, chemical reference substances that are to be used in assays should possess a high degree of purity. As a guiding principle, a purity of 99.5% or higher is desirable, calculated on the basis of the material in its anhydrous form or free of volatile substances. However, where the selectivity of the analytical procedure for which the chemical reference substance is required is low, such a degree of purity may not be necessary. In making a decision about the suitability of a chemical reference substance, the most important consideration is the influence of the impurity on the attribute measured in the assay when used in a non-specific assay procedure. Impurities with physicochemical characteristics similar to those of the main component will not impair the usefulness of a chemical reference substance, whereas even traces of impurities with significantly different properties may render a substance unsuitable as a chemical reference substance.

When source material to be used as a chemical reference substance is obtained from a supplier, the following should be supplied with the material:

- Certificate of analysis with complete information as to test methods employed, values found and number of replicates used, where applicable, and relevant spectra and/or chromatograms.

- Information on optimal storage conditions required for stability (temperature and humidity considerations).
- Results of any hygroscopicity study and/or statement of the hygroscopicity of the source material.
- Results of any accelerated stability studies.
- Identification of detected impurities (by preference), and/or specific information on the relative response factor as determined in compendial methods concerning the principal component, and/or the percentage mass of the impurity.
- Updated Material Safety Data Sheet outlining any health hazards associated with the material.

For new drug substances, manufacturers should be aware that elaboration of pharmacopoeial monographs will be needed and a batch of the new substance should be set aside to be used if necessary as the chemical reference substance. It is desirable for bodies that issue chemical reference substances to provide each other with a sample of the same batch of material, even if the substance will be employed for different test methods. This will require the exchange of information concerning the establishment process, supplier(s), availability and conditions of supply.

3. Evaluation of chemical reference substances

The suitability of a substance proposed for use as a chemical reference requires careful evaluation by the issuing body. It is necessary to consider all data obtained from testing the material by a wide variety of analytical methods. When taken as a whole, this will ensure that the substance is suitable for its intended use. The extent of the analyses required depends on the purpose(s) for which the chemical reference substance is to be employed, and may involve a number of independent laboratories.

3.1 Use in identification tests

For use in identification tests (infrared spectrophotometry and/or chromatographic methods), a batch of good quality material selected from the normal production process is satisfactory if it is of acceptable purity. Additional purification by the supplier may be necessary. The most important check is the application of the test(s) for which the substance is intended. It is usual for at least one laboratory to apply all the tests described in the relevant monograph.

3.2 Use in purity tests

The characterization of a chemical reference substance used in the determination of a specific impurity is more extensive, especially when used in a limit

test. If the technique employed is thin-layer chromatography (TLC) an acceptable minimum purity is recommended (normally at least 90%), but purer material may be required for liquid chromatography (LC) or gas chromatography (GC). If the proposed reference substance is being prepared or isolated for the first time, appropriate chemical and physicochemical tests, such as nuclear magnetic resonance (NMR), mass spectrometry (MS) and elemental analysis, must be applied to characterize it.

3.3 Use in assays

If the chemical reference substance is to be used in an assay (colorimetry, LC, GC or UV spectrophotometry), the extent of testing is very much greater. Several (a minimum of three) laboratories should collaborate in testing the proposed substance, using a variety of established and validated techniques, including the method used in the pharmacopoeial specification. The relative reactivity or relative absorbance of the impurities present must be checked when a non-specific assay method is employed, e.g. by colorimetry or UV spectrophotometry. When a selective assay method is employed, it is particularly important to determine the quantity of impurities. In such a case, it is best to examine the proposed reference substance by as many methods as practicable including, where possible, absolute methods. For substances that are acidic or basic a titration with alkali or acid is simple, but other reactions which are known to be stoichiometric may be used. Phase solubility analysis and differential scanning calorimetry may also be employed in certain cases.

The total of the determinations of water content, organic solvents, mineral impurities and organic components should amount to 100%. For most chemical reference substances intended for assays, the content may be expressed "as is". When establishing the chemical reference substance it is therefore essential to determine the content of water and residual solvents for a non-specific assay, and also to determine the content of impurities for a selective assay.

3.4 Use in the calibration of an instrument

Where the chemical reference substance is to be employed as calibration material, the extent of testing is similar to that for a chemical reference substance used in assays. Several laboratories should collaborate in testing the proposed substance using a variety of techniques to check that its purity is adequate. An appropriate number of collaborating laboratories should also participate, after the reference substance has been deemed suitable, to establish a value for the essential property of the substance using an appropriate instrument.

4. Chemical and physical methods used in evaluating chemical reference substances

It is important to establish by individual testing that a substance proposed for use as a chemical reference is suitable.

The methods used to establish the suitability of such a substance fall into two broad groups: those intended primarily to identify the substance and those used to establish its purity. With most methods, the percentage purity of a chemical reference substance cannot be expressed as an absolute value if the impurities have not been identified. The quoted purity is then an estimate based upon the data obtained by the various analytical methods.

4.1 Methods used to verify the identity of chemical reference substances

Where a proposed substance consists of a compound whose structure has been satisfactorily defined, its identity may be confirmed by matching the IR spectra of the substance to that of an authentic compound. Particular care should be taken when polymorphism exists (7). Other highly specific techniques, such as NMR spectroscopy, MS, or X-ray diffraction crystallography, may also be used for such comparisons. The identity of a substance that is intended to replace an established chemical reference substance of the same molecular constitution must be verified, to determine that the characteristic properties of the two specimens are identical. For this purpose it is often sufficient to compare their IR absorption spectra.

However, where no authentic specimen of the proposed substance is available for comparison, and definitive data about its properties are lacking, it may be necessary to verify its identity by applying several analytical techniques currently used to characterize new compounds. Such analytical methods may include elemental analyses, crystallographic studies, MS, NMR spectroscopy, functional group analyses, and IR or UV spectrophotometry, as well as other supplementary tests as required to establish that the proposed substance is fully characterized.

4.2 Methods used to determine the purity of chemical reference substances

The analytical methods to be employed in examining a substance should be considered in relation to its intended use. These analytical methods may be divided into three broad categories: those that require comparison with an external chemical reference substance (e.g. chromatographic or spectrophotometric methods), those that depend solely on an intrinsic dynamic property (e.g. phase solubility analysis and differential scanning calorimetry) and other methods.

4.2.1 Separation techniques

The methods used for the determination of purity should be established and validated with system suitability requirements as appropriate.

Chromatographic methods. Methods of analysis based on chromatographic separation are especially useful for detecting and determining impurities in

chemical reference substances. High-performance liquid chromatography (HPLC) is the most widely used chromatographic method, but TLC and GC are also used. The individual components separated by chromatographic methods may sometimes be recovered for characterization.

The selectivity of HPLC and of GC usually exceeds that of TLC. Both the first two methods also have the advantage of being readily applicable on a quantitative basis, but they require more complex equipment. HPLC, employing a spectrophotometric method of detection, is of particular value in the examination of chemical reference substances intended for use in UV spectrophotometric assays. The UV wavelength of detection employed for determining the impurity content of the chemical reference substance should be chosen so that the detection responses of the substance and its known impurities are similar. When the response factors are significantly different at the optimal wavelength of detection, appropriate corrections must be made to estimate the content of impurities. LC with diode-array detection is very useful for recording the UV spectra of both the main peak and the impurities. LC with MS detection is used for identification of separated impurities as well as for the main component, and is particularly important for chemical reference substances where no other reference standards or IR reference spectra are available.

In a GC method used for an assay, as with LC, the detection responses of the known impurities are determined. Generally, GC monograph methods are of particular value in detecting and determining volatile impurities, including solvent residues, in chemical reference substances.

TLC uses apparatus that is simple and cheap; the technique is easy to carry out and is readily applicable even in the microgram range. It can separate closely related compounds, such as geometric isomers and the members of a homologous series. All the constituents of a substance submitted to chromatography appear somewhere on the chromatogram. However, some constituents may remain on the starting line, some may move with the solvent front, some may migrate at the same rate as the main component, and some may remain undetected. For this reason, the usefulness of the method may be greatly enhanced by means of two-dimensional chromatography and by using a number of different solvent systems and a variety of detection methods. In some cases the method may be used quantitatively with acceptable accuracy by using a densitometer.

Capillary electrophoresis. Capillary electrophoresis is an increasingly common method. It may be considered as complementary to LC for detecting impurities.

4.2.2 *Methods based on intrinsic thermodynamic properties*

Methods in this group measure total impurity levels in absolute terms.

Differential scanning calorimetry. This technique is used to check the presence of different polymorphic forms and to determine the total amount of solid impurities. Purity estimation is based on determination of the heat of fusion

of the sample and of the change in its melting point caused by the presence of impurities. This analytical method can be performed rapidly and with high precision. However, it is not applicable if the substance decomposes on melting. This limits its value as a general procedure for purity estimation of chemical reference substances. It is also inapplicable if solid solutions are formed.

Phase solubility analysis. The method has occasionally been used, but its value is limited and the procedure is time consuming. It may be employed to detect contaminating substances, including isomeric species, and to estimate their concentration. Some factors that may make the method inapplicable are degradation of the substance during the course of analysis, formation of a solid solution, and polymorphism in the main component.

4.2.3 Other methods

Spectrophotometric methods. UV spectrophotometry is occasionally used to determine purity. Since it depends upon the presence of a characteristic chromophore, it can detect impurities that contribute excessively to the absorbance value and may indicate the presence of impurities that have a negligible or distinctive absorbance.

However, the utility of the method is limited by the small number of absorption maxima in the UV range, the large numbers of compounds containing similar characteristic chromophores, and the need for an external chemical reference substance.

IR spectrophotometry may be used to identify and determine the proportions of geometric isomers. NMR spectroscopy, a powerful spectroscopic identification tool, is also occasionally useful in the determination of purity.

Titrimetric methods. Titrimetric methods provide a valuable means of confirming the identity and purity of a proposed chemical reference substance and are useful in confirming purity values obtained by other methods.

Optical rotation methods. Many chemical reference substances are optically active and the relative proportion of optical isomers can sometimes be determined by an optical rotation method, but generally such methods lack sensitivity. However, the quantitative use of these techniques is well established and can yield results of high precision, depending on the solvent and the wavelength chosen for measurement. Chiral chromatography and NMR are becoming increasingly important.

Determination of water and organic volatiles. It is essential that an accurate assessment of the moisture content and the content of volatile contaminants be made. These total values may often be obtained by drying under defined conditions that are appropriate to the proposed substance. Sometimes this may not be possible or may yield misleading results. In such cases, thermogravimetric analysis may be used to determine the water and volatile content. Alternatively,

the water content may be determined by Karl Fischer titration and the content of volatile solvents by GC. Without an accurate assessment of these values at the time that other determinations are being made, judgements of the acceptability of the proposed chemical reference substance will be invalid.

5. Assignment of content

If a content is to be assigned to a chemical reference substance, it should be borne in mind that the value is based on the results of a collaborative interlaboratory programme using different analytical methods. This experimentally obtained value represents the best estimate of the true value. In general, the assignment of content for a chemical reference substance is 100% minus the content of water and volatiles, and when a substance is intended for use as an assay standard based on a separation technique the impurity content, as determined by that method, must also be subtracted. Sometimes the chemical reference substances must be dried before use, in which case the content is expressed on the basis of the dried material.

6. Handling and distribution of chemical reference substances

The handling, distribution and use of established chemical reference substances must ensure that their integrity is safeguarded and maintained throughout their period of use.

6.1 Packaging operations

Current GMP requirements (5) should be observed. The various stages in packaging chemical reference substances should be clearly defined and controlled, to avoid contamination of the sample, mislabelling of containers, or any other event which might result in mishandling or mismanagement.

Containers for chemical reference substances should protect their contents from moisture, light and oxygen and must be tested for moisture permeability.

Additional measures may be necessary to ensure long-term integrity and stability. The best containers for chemical reference substances from the point of view of stability are sealed glass ampoules, but these have certain disadvantages. There is the risk of contaminating the substance with glass particles when the ampoules are opened, and reclosure is difficult. Sealable glass ampoules are therefore principally used for substances that must be kept in an oxygen-free atmosphere. Certain other substances may require even more elaborate protection. Most chemical reference substances, however, are conveniently supplied in reclosable containers which should be uniform in type and size to facilitate distribution. The lack of permeability to moisture is an important factor in determining the suitability of container closure systems.

Before undertaking any packaging operations, the health hazards of the item to be packaged should be assessed through information sources, e.g. the Material Safety Data Sheet. Appropriate precautions should be taken to protect the person handling the chemical reference substance.

The packaging of a batch of a chemical reference substance into containers is a small-scale operation for which suitable equipment is now always available to the manufacturer of the material. Therefore, the packaging of chemical reference substances is usually undertaken by the responsible issuing body. Screw-type feeders have been constructed, but generally the packaging of chemical reference substances is carried out manually. Substances which are expensive or only available in very small quantities may have to be divided between containers in solution and then lyophilized, or evaporated to dryness.

Some chemical reference substances must be packaged under an inert gas or in conditions of controlled humidity. Therefore, the use of a glove-box or an air-tight cabinet is necessary.

6.2 Storage

Information about suitable storage conditions can often be obtained from the manufacturer of the source material and should be requested routinely when a new chemical reference substance is established. Theoretically, the stability of the substances should be enhanced by keeping them at low temperatures but, for substances that contain water, storage below 0°C may impair the stability. It should also be remembered that the relative humidity in normal refrigerators or cold-rooms may be high and, unless ampoules or other tightly closed containers are used, the improvement in stability may be more than offset by degradation due to the absorption of moisture. Storage at about +5°C, with precautions to prevent such absorption, has proved satisfactory for most chemical reference substances.

6.3 Stability

A chemical reference substance is an integral part of the drug specification. Thus, if the reference substance deteriorates, this will change the specification of the drug. It is therefore of the utmost importance that the stability of chemical reference substances should be monitored by regular re-examination and that they should be replaced as soon as a significant change in a property is noted.

The definition of what is a "significant change" differs according to the intended use of the chemical reference substance. Several per cent of degradation products found in a substance may not impair the usefulness of the material in identification tests. For chemical reference substances that are used in chromatographic assays, however, even small amounts of impurities may be unacceptable. When establishing a chemical reference substance, consideration must be given to its intended use and to the performance characteristics of the analytical methods in which it will be used. The tolerable degree of degradation will be different from case to case.

Laboratories in charge of collections of chemical reference substances should have a system for regular re-examination of the materials in stock. The frequency of re-testing may be modified according to the need. It must be borne

in mind that the stability of a specially prepared chemical reference substance may not always be the same as that of commercial samples of the same material.

The selection of suitable analytical methods for monitoring the stability of chemical reference substances depends on the nature and intended use of the substance. A substance used solely for identification purposes will normally only require demonstration that it is still suitable for this use, e.g. that the IR spectrum is identical to that obtained during establishment. If substances are employed for other purposes, the testing must be more extensive but should use methods which are rapid and sensitive so as not to consume too much of the existing stock. It is important to check that there has been no significant uptake of moisture, which could result in degradation by hydrolysis and/or a decrease in the assigned content of the substance. Chromatography is employed extensively, as well as absolute methods such as differential scanning calorimetry where applicable. Changes in the impurity profile or purity determination usually mean that the batch must be replaced. Changes which compromise the integrity of the batch indicate it should immediately be withdrawn from use. Sometimes a batch of a chemical reference substance will discolour or otherwise change in appearance. Steps should be taken to replace this substance whether or not the results of subsequent analyses indicate significant degradation. Such changes in physical appearance reduce the confidence of the user in the suitability of the chemical reference substance. Appropriate testing of active bulk substance should be carried out before further dispensing into vials or ampoules.

6.4 Information to be supplied with chemical reference substances

Labels on chemical reference substances should give the following information:

- the appropriate name of the substance: the international nonproprietary name (INN) should be used wherever possible;
- name and address of the issuing body;
- approximate quantity of material in the container; and
- batch or control number.

Where associated documents are provided they should incorporate relevant items from the list above. The following information should be given, as necessary, on the labels and/or in associated documents:

- recommended storage conditions (if special conditions apply);
- intended use of the chemical reference substance;
- directions for use (e.g. storage and handling);
- information about assigned analytical value of the chemical reference substance (needed for calculation of the results of tests in which the substance will be used);

- a disclaimer of responsibility when chemical reference substances are misused, or stored under inappropriate conditions, or used for other purposes than those intended by the issuing body; and
- health hazard information or warning in conformity with national and regional regulations or international agreements.

If analytical data are to be supplied with the chemical reference substances, it is recommended that the data provided be limited to what is necessary for the proper use of the substances in the tests and assays.

6.5 Distribution and supply

Distribution of chemical reference substances within the same country usually does not present problems. However, when samples are to be sent to other countries, both the sender and the receiver of the goods may encounter difficulties because of the vagaries of postal and customs regulations, e.g. the application of special procedural requirements applicable to substances under international control. Distributors of chemical reference substances waste considerable resources in seeking information on different international import regulations, and in completing the required forms. A way of reducing such difficulties and barriers to effective distribution of chemical reference substances should be sought. There should be the minimum delay in providing the chemical reference substances to the users, and the most speedy means of transport should be chosen.

6.6 Period of use

Chemical reference substances do not carry an “expiry date” in the conventional sense. To avoid the unnecessary discarding of satisfactory substances, a mechanism for general control of the batch of a chemical reference substance may be used by the issuing body. If the issuing body applies stability considerations and a monitoring procedure based on its experience to its collection, this should guarantee the user of the acceptability of the chemical reference substance for its intended use.

If it is considered necessary to specify a beyond-use date, it should be stated on the label and/or on a document accompanying the chemical reference substances. Adequate shipping records should exist to enable contact with the purchaser of a batch for recall or other notification.

The storage and maintenance of unopened containers of the chemical reference substance in accordance with information provided are integral to its suitability of use. To avoid potential doubts concerning the integrity of opened containers, it is suggested that potential users obtain only the quantities of substances necessary for short-term need and obtain fresh stocks (held under controlled and known conditions) when needed. Long-term storage of substances in opened containers is to be avoided. Similarly, efforts should be made to avoid

possible degradation, contamination and/or introduction of moisture during the repeated use of a substance.

Part B. Secondary chemical reference substances

The establishment of secondary chemical reference substances calibrated against a primary chemical reference substance may be desirable for various practical reasons, e.g. the latter may not be available in adequate quantities to supply all local needs. Moreover, the availability of such secondary chemical reference substances (for example, on a regional basis) would reduce the delay in receiving the reference material.

The body which establishes a secondary chemical reference substance for national/regional use should be clearly defined by the competent drug regulatory authority. Clear documentation must exist to establish the relationship between the secondary and the primary chemical reference substance.

References

1. *WHO Expert Committee on Specifications for Pharmaceutical Preparations. Twenty-fifth report.* Geneva, World Health Organization, 1975, Annex 3 (WHO Technical Report Series, No. 567).
2. *The International Pharmacopoeia*, 3rd ed. Vol. 1. *General methods of analysis*; Vol. 2. *Quality specifications*; Vol. 3. *Quality specifications*; Vol. 4. *Tests, methods, and general requirements. Quality specifications for pharmaceutical substances, excipients, and dosage forms.* Geneva, World Health Organization, 1979–1994.
3. *WHO Expert Committee on Specifications for Pharmaceutical Preparations. Twenty-eighth report.* Geneva, World Health Organization, 1982, Annex 1 (WHO Technical Report Series, No. 681).
4. Good laboratory practices in governmental drug control laboratories. In: *WHO Expert Committee on Specifications for Pharmaceutical Preparations. Thirtieth report.* Geneva, World Health Organization, 1987, Annex 1 (WHO Technical Report Series, No. 748).
5. Good manufacturing practices for pharmaceutical products. In: *WHO Expert Committee on Specifications for Pharmaceutical Preparations. Thirty-second report.* Geneva, World Health Organization, 1992, Annex 1 (WHO Technical Report Series, No. 823).
6. Good manufacturing practices for biological products. In: *WHO Expert Committee on Specifications for Pharmaceutical Preparations. Thirty-third report.* Geneva, World Health Organization, 1993, Annex 3 (WHO Technical Report Series, No. 834).
7. General recommendations for the preparation and use of infrared spectra in pharmaceutical analysis. In: *WHO Expert Committee on Specifications for Pharmaceutical Preparations. Thirty-fourth report.* Geneva, World Health Organization, 1996, Annex 4 (WHO Technical Report Series, No. 863).

Index

For the convenience of users of Volume 5, the reagents, test solutions, and volumetric solutions described in Volumes 1, 2, 3, and 4 are also listed in this index. The numbers printed in bold type, preceding the page numbers, indicate the volume in which the indexed item is to be found.

A

- Abbreviations and symbols, **4**, 9, **5**, 2
for reagents, test solutions and
volumetric solutions, **1**, 13, 167; **2**, 279; **3**,
339; **4**, 293; **5**, 235
- Absolute alcohol, *see* Ethanol
- Acacia, **4**, 181
- Acacia R, (5 g/l) TS, **3**, 339
- Acetaldehyde R, **5**, 237
- p*-Acetamidobenzalazine RS, **3**, 339
- Acetaminophen, *see* Paracetamol
- Acetate buffer, pH 3.0, TS, **1**, 167; pH 4.5,
TS, **3**, 339; pH 4.6, TS, **4**, 295; pH 4.7,
TS, **3**, 339; pH 5.0, TS, pH 5.5, TS, **3**,
340; pH 6.0, TS, **4**, 295
- Acetate standard buffer, TS, **2**, 279
- Acetazolamide, **2**, 17
- Acetazolamide RS, **2**, 279
- Acetazolamidum, **2**, 17
- Acetic acid, **4**, 107
dilute, *see* Acetic acid
glacial, R, **1**, 168; R1, **2**, 279
- Acetic acid (~330 g/l) TS, **1**, 168; (~120 g/l)
TS, (~90 g/l) TS, **3**, 340; (~60 g/l) TS,
(~60 g/l) PbTS, **1**, 168; (5.0 g/l) TS, **3**,
340; (0.07 mol/l) VS, **4**, 295
- Acetic anhydride R, **1**, 168
- Acetic anhydride/dioxan TS, **2**, 280
- Acetone R, **1**, 168
- Acetonitrile R, (400 g/l) TS, **1**, 168
- Acetyl chloride R, **2**, 280
- Acetylated substances, **1**, 111
- Acetylsalicylic acid, **2**, 19
tablets, **4**, 226
- Acid value, determination of, **1**, 140
- Acidi acetylsalicylici compressi, **4**, 226
- Acids, *see under name of acid*
- Acidum aceticum, **4**, 107
- Acidum acetylsalicylicum, **2**, 19
- Acidum alginicum, **4**, 109
- Acidum amidotrizoicum, **4**, 97; **5**, 304
- Acidum ascorbicum, **2**, 21; **3**, 379
- Acidum benzoicum, **2**, 22
- Acidum citricum, **4**, 110; **5**, 305
- Acidum folicum, **2**, 24
- Acidum hydrochloricum, **4**, 112
- Acidum hydrochloricum dilutum, **4**, 114
- Acidum iopanoicum, **4**, 53; **5**, 298
- Acidum iotroxicum, **4**, 100; **5**, 304
- Acidum lacticum, **4**, 115; **5**, 305
- Acidum nicotinicum, **2**, 26
- Acidum salicylicum, **2**, 28
- Acknowledgements, **1**, 8; **2**, 7; **3**, 10; **4**, xii; **5**,
xiv
- Actinomycin D, *see* Dactinomycin
- Activated charcoal, **2**, 62; **3**, 380
- Adeps lanae, **4**, 118
cum aqua, **4**, 118
- Adeps solidus, **4**, 120
- Adrenalin, *see* Epinephrine
- Adrenalin tartrate, *see* Epinephrine
hydrogen tartrate
- Adriamycin, *see* Doxorubicin hydrochloride
- Agar R, **1**, 168
- Albendazole, **5**, 39
- Albendazole RS, **5**, 237
- Albendazolium, **5**, 39
- Alcohol, **4**, 125
ethyl, *see* Ethanol
isopropyl, *see* 2-Propanol
methyl, *see* Methanol
- Alcohol benzylicus, **4**, 121
- Alcohol cetylicus, **4**, 123
- Alcohol cetylstearylicus, **4**, 124
- Alcohololum, **4**, 125
- Alcuronii chloridum, **5**, 41
- Alcuronium chloride, **5**, 41
- Alcuronium chloride RS, **5**, 237
- Alginate acid, **4**, 109
- Alizarin Red S, *see* Sodium
alizarinsulfonate
- Allopurinol, **2**, 30
tablets, **5**, 149
- Allopurinol RS, **2**, 280
- Allopurinoli compressi, **5**, 149
- Allopurinolum, **2**, 30
- Alum R, **4**, 295
- Aluminii hydroxidum, **3**, 15
- Aluminii magnesii silicas, **4**, 127
- Aluminii sulfas, **4**, 54; **5**, 298
- Aluminium, by complexometry, **1**, 128
- Aluminium R, **2**, 280
- Aluminium chloride R, TS, **2**, 280
- Aluminium hydroxide, **3**, 15
- Aluminium hydroxide R, **1**, 168
- Aluminium magnesium silicate, **4**, 127
- Aluminium oxide R, **5**, 237

- Aluminium standard (10 µg Al/ml) TS, **4**, 295
Aluminium sulfate, **4**, **54**; **5**, 298
Aluminum, *see* Aluminium
Amendments and corrigenda to
 Volumes 1 and 2, **3**, 371
 Volumes 1, 2, and 3, **4**, 311
 Volumes 1, 2, 3, and 4, **5**, 255
Amethocaine hydrochloride, *see* Tetracaine hydrochloride
Amidotrizoic acid, **4**, **97**; **5**, 304
Amidotrizoic acid RS, **4**, **97**
Amikacin, **3**, 17
Amikacin sulfate, **3**, 18; **5**, 280
Amikacini sulfas, **3**, 18; **5**, 280
Amikacinum, **3**, 17
Amiloride hydrochloride, **3**, 21
Amiloride hydrochloride RS, **3**, 340
Amiloridi hydrochloridum, **3**, 21
Amines, primary aromatic, **1**, 111
4-Aminoantipyrine R, TS1, TS2, **3**, 340
4-Aminobenzoic acid R, **2**, 280
4-Aminobutanol R, **2**, 281
4-Amino-6-chloro-1,3-benzenedisulfonamide R, **2**, 281
7-[(2-Aminoethyl)amino]-1-cyclopropyl-6-fluoro-1,4-dihydro-4-oxo-quinoline-3-carboxylic acid RS, **5**, 237
2-Amino-5-nitrothiazole R, **3**, 340
4-Aminophenol R, **3**, 341
4-Aminophenol-free paracetamol R, **3**, 358
Aminophylline, **2**, 31; **5**, 265
Aminophyllinum, **2**, 31; **5**, 265
Aminopyrazole-4-carboxamide hemisulfate RS, **2**, 281
Aminopyrazolone, *see* 4-Aminoantipyrine
3-Amino-2,4,6-triiodobenzoic acid RS, **4**, 295
Amitriptyline hydrochloride, **2**, 34
Amitriptylini hydrochloridum, **2**, 34
Ammonia, strong, *see* Ammonia (~260 g/l) TS and volatile aliphatic amines, **1**, 111
Ammonia (~260 g/l) TS, (~100 g/l) TS, **1**, 168; (~100 g/l) FeTS, **2**, 281, **4**, 313; (~100 g/l) PbTS, **1**, 168; (~50 g/l) TS, **3**, 341; (~35 g/l) TS, (~17 g/l) TS, **2**, 282
Ammonia buffer TS, **1**, 169
Ammonium, **1**, 111
Ammonium acetate R, **1**, 169; (100 g/l) TS, **3**, 341; (80 g/l) TS, **1**, 169; (50 g/l) TS, **5**, 237; (40 g/l) TS, (2 g/l) TS, **3**, 341; TS, **5**, 237
Ammonium acetate buffer, pH 4.62, TS, **3**, 341
Ammonium carbonate R, **1**, 169
Ammonium chloride R, **1**, 169; TS, dilute, TS, **4**, 296; (100 g/l) TS, **2**, 282; (20 g/l) TS, **5**, 237; (10 µg/ml NH₄) TS, **1**, 169
Ammonium chloride buffer, pH 10.0, TS, **1**, 169; pH 10.5, TS, **4**, 295
Ammonium hydroxide, *see* Ammonia
Ammonium mercurithiocyanate TS, **3**, 341
Ammonium molybdate R, **1**, 169; (95 g/l) TS, **1**, 169; (45 g/l) TS, **2**, 282
Ammonium molybdate/nitric acid TS, **2**, 282
Ammonium molybdate/sulfuric acid RS, **3**, 341
Ammonium molybdate/vanadate TS, **3**, 341
Ammonium nitrate R, (50 g/l) TS, **2**, 282; TS, **5**, 237
Ammonium oxalate R, **1**, 169; (50 g/l) TS, **2**, 282; (25 g/l) TS, **1**, 169
Ammonium persulfate R, **3**, 341
Ammonium persulfate/phosphate buffer TS, **3**, 341
Ammonium phosphate, *see* Diammonium hydrogen phosphate
Ammonium pyrrolidinedithiocarbamate R, (10 g/l) TS, **4**, 296
Ammonium reineckate R, (10 g/l) TS, **3**, 342
Ammonium sulfamate R, **2**, 282; (50 g/l) TS, **3**, 342; (25 g/l) TS, (5 g/l) TS, **2**, 282
Ammonium sulfate R, **2**, 282
Ammonium sulfide TS, **3**, 342
Ammonium thiocyanate R, (75 g/l) TS, **1**, 169; (10 g/l) TS, **5**, 237; (0.1 mol/l) VS, **1**, 169; (0.05 mol/l) VS, **4**, 296; (0.01 mol/l) VS, **1**, 170
Ammonium thiocyanate/cobalt(II) nitrate TS, **3**, 342
Ammonium vanadate R, **3**, 342
Amodiaquine, **3**, 23
Amodiaquine hydrochloride, **2**, 35
Amodiaquine hydrochloride RS, **3**, 342
Amodiaquini hydrochloridum, **2**, 35
Amodiaquinum, **3**, 23
Amoxicillin trihydrate, **5**, 43
Amoxicillin trihydrate RS, **5**, 238
Amoxicillinum trihydricum, **5**, 43
Amphotericin B, **3**, 25; **5**, 281
 powder for injections, **4**, 273; **5**, 309
Amphotericin B RS, **3**, 342
Amphotericini B pulvis ad injectionem, **4**, 273; **5**, 309
Amphotericinum B, **3**, 25; **5**, 281
Ampicillin, **2**, 37
 capsules, **4**, 222; **5**, 309
Ampicillin RS, **2**, 282
Ampicillin sodium, **2**, 40; **3**, 379; **4**, 313; **5**, 266
 powder for injections, **4**, 275; **5**, 310
Ampicillin sodium RS, **2**, 282
Ampicillin trihydrate RS, **2**, 282
Ampicillini capsulae, **4**, 222; **5**, 309
Ampicillini natrici pulvis ad injectionem, **4**, 275; **5**, 310
Ampicillinum, **2**, 37
Ampicillinum natricum, **2**, 40; **3**, 379; **4**, 313; **5**, 266
Amprone, *see* 4-Aminoantipyrine
Amyl alcohol R, **2**, 282
Amyla, **4**, 129; **5**, 306
Anaesthetic ether, **3**, 128
Anhydrotetracycline hydrochloride RS, **2**, 282
Anhydrous calcium chloride R, **1**, 172
Anhydrous disodium hydrogen phosphate R, **1**, 179

- Anhydrous glucose R, **3**, 352
 Anhydrous lanolin, *see* Wool fat
 Anhydrous potassium carbonate, **3**, 362
 Anhydrous pyridine R, **1**, 201
 Anhydrous sodium carbonate R, **1**, 203
 Anhydrous sodium sulfate, **3**, 205
 Anhydrous sodium sulfate R, **1**, 206
 Aniline R, (25 g/l) TS, **2**, 283
 Anisaldehyde R, TS, **5**, 238
 Anisaldehyde/methanol TS, **5**, 238
 Anisaldehyde/sulfuric acid TS, **5**, 238
 Anthrone R, TS, **3**, 342; TS2, **5**, 238
 Antibiotics, microbiological assay of, **1**, 145
 sterility testing, **1**, 151
 Antimalarial drugs, monographs for, **5**, 185
 Antimony sodium tartrate, **3**, 293
 Antimony sodium tartrate R, (50 g/l) TS, **1**, 170
 Antimony trichloride R, TS, **2**, 283
 Apressinum, *see* Hydralazine hydrochloride
 Aprotinin R, **5**, 238
 Aqua pro injectione, **4**, 132; **5**, 253, 307
 Aqua purificata, **4**, 131; **5**, 306
 Aqua sterilisata pro injectione, **4**, 134; **5**, 307
 Arachis oil, **4**, 197
 Arachis oil R, **4**, 296
 Argenti nitras, **3**, 28
 Argon R, **5**, 238
 Arsenic, dilute, AsTS, **1**, 170
 limit test for, **1**, 121
 strong, AsTS, **1**, 170
 Arsenic trioxide R, **1**, 170; R1, **2**, 283
 Artemether, **5**, 187
 capsules, **5**, 190
 injection, **5**, 195
 tablets, **5**, 193
 Artemether RS, **5**, 238
 Artemetheri
 capsulae, **5**, 190
 compressi, **5**, 193
 infectio, **5**, 195
 Artemetherum, **5**, 187
 Artemisinin, **5**, 198
 capsules, **5**, 202
 tablets, **5**, 205
 Artemisinin RS, **5**, 238
 Artemisinini
 capsulae, **5**, 202
 compressi, **5**, 205
 Artemisininum, **5**, 198
 Artemotil, **5**, 209
 injection, **5**, 212
 Artemotil RS, **5**, 238
 Artemotili infectio, **5**, 212
 Artemotilum, **5**, 209
 Artenimol, **5**, 215
 tablets, **5**, 218
 Artenimol RS, **5**, 238
 Artenimoli compressi, **5**, 218
 Artenimolum, **5**, 215
 Artesunate, **5**, 222
 tablets, **5**, 225
 Artesunate RS, **5**, 238
 Artesunati compressi, **5**, 225
 Artesunatum, **5**, 222
 Ascorbic acid, **2**, 21; **3**, 379
 Ash, and acid-insoluble ash, determination of,
 1, 161
 sulfated, **1**, 123
 Aspirin, *see* Acetylsalicylic acid
 Assays and tests, **4**, 5
 Atenolol, **5**, 47
 for column validation RS, **5**, 239
 Atenolol RS, **5**, 239
 Atenololum, **5**, 47
 Atomic absorption spectrophotometry, **1**, 43
 Atomic emission and absorption
 spectrometry, **4**, 23
 Atropine sulfate, **2**, 43; **5**, 266
 tablets, **4**, 227
 Atropine sulfate RS, **2**, 283
 Atropini sulfas, **2**, 43; **5**, 266
 Atropini sulfatis compressi, **4**, 227
 Autoclave, heating in an, **4**, 19
 Azathioprine, **3**, 29
 Azathioprine RS, **3**, 342
 Azathioprinum, **3**, 29
 Azo violet R, **2**, 283; TS, **2**, 284
- ## B
- Bacitracin, **3**, 31; **5**, 281
 Bacitracin zinc, **3**, 33; **5**, 282
 Bacitracin zinc RS, **3**, 342
 Bacitracinum, **3**, 31; **5**, 281
 Bacitracinum zincum, **3**, 33; **5**, 282
 Bacterial endotoxins, test for, **5**, 30
 Barii sulfas, **3**, 35
 Barium chloride R, (50 g/l) TS, (0.5 mol/l) VS,
 1, 170
 Barium hydroxide R, (15 g/l) TS, **2**, 284;
 (0.15 mol/l) VS, **5**, 239
 Barium nitrate R, (0.01 mol/l) VS, **1**, 170
 Barium oxide R, **1**, 171
 Barium sulfate, **3**, 35
 Barium sulfate suspension TS, **1**, 171
 Basic blue 20, *see* Methyl green
 Beclometasone dipropionate, **3**, 37; **4**, 315
 Beclometasone dipropionate RS, **3**, 342
 Beclometasoni dipropionas, **3**, 37; **4**, 315
 Beef extract R, **1**, 171
 Bentonite, **4**, 135
 Bentonium, **4**, 135
 Benzalkonii chloridum, **4**, 137
 Benzalkonium chloride, **4**, 137
 Benzalkonium chloride TS, TS1, **2**, 284
 Benzathine benzylpenicillin, **3**, 39; **5**, 282
 Benzathini benzylpenicillinum, **3**, 39; **5**, 282
 Benzene R, **2**, 284
 Benzhexol hydrochloride, *see*
 Trihexyphenidyl hydrochloride
 Benznidazole, **5**, 49

- Benznidazole RS, **5**, 239
 Benznidazolium, **5**, 49
 Benzocaine, **2**, 45
 Benzocainum, **2**, 45
 Benzoic acid, **2**, 22
 Benzoic acid R, **2**, 284
 Benzophenone R, **5**, 239
 Benzoyl chloride R, **2**, 285
 Benzoyl peroxide, hydrous, **5**, 51
 Benzoyl peroxide, hydrous R, **5**, 239
 Benzoylis peroxidum cum aqua, **5**, 51
 Benzyl alcohol, **4**, 121
 Benzyl alcohol R, **3**, 343
 Benzyl benzoate, **2**, 46
 Benzyl benzoate R, **5**, 239
 Benzyl hydroxybenzoate, **4**, 138; **5**, 307
 Benzylis benzoas, **2**, 46
 Benzylis hydroxybenzoas, **4**, 138; **5**, 307
 Benzylpenicillin potassium, **2**, 48; **3**, 379; **5**, 267
 powder for injections, **4**, 278; **5**, 310
 Benzylpenicillin potassium RS, **2**, 285
 Benzylpenicillin sodium, **2**, 51; **3**, 379; **5**, 267
 Benzylpenicillin sodium R, TS, **1**, 171; RS, **2**, 285
 Benzylpenicillini kalici pulvis ad injectionem, **4**, 278; **5**, 310
 Benzylpenicillinum kalicum, **2**, 48; **3**, 379; **5**, 266
 Benzylpenicillinum natricum, **2**, 51; **3**, 379; **5**, 267
 Bephenii hydroxynaphthoate, **2**, 53
 Bephenium hydroxynaphthoate, **2**, 53
 Bephenium hydroxynaphthoate RS, **2**, 285
 Betamethasone, **2**, 55
 Betamethasone RS, **2**, 285
 Betamethasone sodium phosphate RS, **4**, 296
 Betamethasone valerate, **3**, 42
 Betamethasone valerate RS, **3**, 343
 Betamethasoni valeras, **3**, 42
 Betamethasonum, **2**, 55
 BHA, *see* Butylated hydroxyanisole
 BHT, *see* Butylated hydroxytoluene
 Biological reference standards and preparations, **4**, 8
 Biperiden, **3**, 45; **5**, 282
 Biperiden RS, **3**, 343
 Biperiden hydrochloride, **3**, 46
 Biperiden hydrochloride RS, **3**, 343
 Biperideni hydrochloridum, **3**, 46
 Biperidenum, **3**, 45; **5**, 282
 9,9-Bisanthracene-10,10'(9*H*,9'*H*)-dione RS, **5**, 239
 4,4'Bis(dimethylamino)benzophenone R, **5**, 239
 Bismuth, **1**, 112
 by complexometry, **1**, 128
 Bismuth oxynitrate R, **2**, 285
 Bismuth subnitrate R, **4**, 296
 Bleomycin hydrochloride, **3**, 48; **5**, 283
 Bleomycin sulfate, **3**, 52; **5**, 283
 Bleomycini hydrochloridum, **3**, 48; **5**, 283
 Bleomycini sulfas, **3**, 52; **5**, 283
 Blue tetrazolium R, **2**, 285; **5**, 280
 Blue tetrazolium/ethanol TS, **2**, 286
 Blue tetrazolium/sodium hydroxide TS, **2**, 286
 Boiling point, determination of, **1**, 19
 Boiling range, determination of, **1**, 19
 Bolus alba, *see* Kaolin
 Borax, *see* Sodium tetraborate
 Boric acid R, (50 g/l) TS, **1**, 171
 Brilliant green R, **4**, 296
 Brilliant green/acetic acid TS, **4**, 296
 Bromides, **1**, 112
 Bromine, determination of, **1**, 124
 Bromine R, TS1, AsTS, **1**, 172
 Bromocresol green R, **2**, 286; TS1, **4**, 296
 Bromocresol green/ethanol TS, **2**, 286
 Bromocresol purple R, **2**, 286
 Bromocresol purple/ethanol TS, **2**, 286
 Bromophenol blue R, **1**, 172; TS, **4**, 297, (1 g/l) TS, **5**, 239
 Bromophenol blue/ethanol TS, **1**, 172
 Bromothymol blue R, **1**, 172
 Bromothymol blue/dimethylformamide TS, **2**, 286
 Bromothymol blue/ethanol TS, **1**, 172
 Brown stock standard TS, **1**, 172
 Buccal tablets, **4**, 30
 Buffer borate, pH 8.0, TS, pH 9.0, TS, pH 9.6, TS, **2**, 286
 Buffer pH 1.3, **5**, 243
 Buffer pH 2.5, **5**, 243
 Buffer pH 3.5, **5**, 243
 Buffer pH 4.5, **5**, 243
 Buffer pH 6.8, **5**, 243
 Buffer pH 7.2, **5**, 243
 Buffer phosphate, pH 6.4, TS, pH 6.9, TS, **2**, 287
 Buffer phthalate, pH 3.4, TS, pH 3.5, TS, **2**, 287
 Buffer solutions, *see under name of buffer*
 Buffers suitable for use in the dissolution test, pH 1.3, pH 2.5, pH 3.5, pH 4.5, pH 6.8, pH 7.2, **5**, 243
 Bupivacaine hydrochloride, **2**, 58; **5**, 267
 Bupivacaine hydrochloride RS, **2**, 287
 Bupivacaini hydrochloridum, **2**, 58; **5**, 267
 Busulfan, **3**, 55
 Busulfanum, **3**, 55
 1-Butanol R, **2**, 287
 2-Butanol R, **3**, 343
tert-Butanol R, **2**, 287
 Butyl acetate R, **3**, 343
tert-Butyl methyl ether R, **5**, 239
 1-Butylamine R, **2**, 287
 Butylated hydroxyanisole, **4**, 140; **5**, 307
 Butylated hydroxyanisole R, **5**, 239
 Butylated hydroxytoluene, **4**, 142
 Butylated hydroxytoluene R, **3**, 343

Butylhydroxyanisolum, **4**, 140; **5**, 307
Butylhydroxytoluenum, **4**, 142

C

- Cadmium acetate R, **2**, 288
Caesium chloride R, **5**, 239
Caffeine, **2**, 85
Caffeine RS, **2**, 288
Calamine, **4**, 56
Calaminum, **4**, 56
Calciferol, *see* Ergocalciferol
Calcii carbonas, **3**, 57
Calcii folinas, **3**, 59; **5**, 284
Calcii gluconas, **2**, 60; **3**, 379; **5**, 268
Calcii hydrogenophosphas, **4**, 143
Calcii phosphas, **4**, 146
Calcii stearas, **4**, 148
Calcii sulfas, **4**, 149
Calcium, **1**, 112
 by complexometry, **1**, 128
Calcium acetate R, (0.25 mol/l) VS, **4**, 297
Calcium carbonate, **3**, 57
Calcium carbonate R1, R2, **1**, 172
Calcium chloride, *see* Calcium chloride,
 anhydrous
Calcium chloride, anhydrous, R, hydrated,
 (55 g/l) TS, **1**, 172; (3.7 g/l) TS, **5**, 240
Calcium fluoride R, **4**, 297
Calcium folinate, **3**, 59; **5**, 284
Calcium folinate RS, **3**, 343
Calcium gluconate, **2**, 60; **3**, 379; **5**, 268
Calcium hydrogen phosphate, **4**, 143
 anhydrous, **4**, 143
 dihydrate, **4**, 143
Calcium hydroxide R, TS, **2**, 288
Calcium phosphate, **4**, 146
Calcium standard (100 µg/ml Ca), ethanolic,
 TS, **3**, 343
Calcium standard (10 µg/ml Ca) TS, **3**, 343
Calcium stearate, **4**, 148
Calcium sulfate, **4**, 149
Calcium sulfate R, hemihydrate R, **3**, 343; TS,
 3, 344
Calcon R, **1**, 172
Calcon indicator mixture R, **1**, 173
Calcon carboxylic acid R, **1**, 173
Calcon carboxylic acid indicator mixture R, **1**,
 173
Calculation of results, **1**, 11; **4**, 6
Caprylic acid, *see* Octanoic acid
Capsules, **4**, 32, 222
 delayed-release, **4**, 36
 enteric, **4**, 36
 extended-release, **4**, 35
 hard, **4**, 33
 modified-release, **4**, 35
 soft, **4**, 34
 specific types, **4**, 33
Capsules and tablets, disintegration test for,
 4, 40
Captopril, **5**, 54
Captopril RS, **5**, 240
Captopril disulfide RS, **5**, 240
Captoprilum, **5**, 54
Carbamazepine, **3**, 61
 tablets, **5**, 150
Carbamazepine RS, **3**, 344
Carbamazepini compressi, **5**, 150
Carbamazepinum, **3**, 61
Carbidopa, **3**, 63; **5**, 284
Carbidopa RS, **3**, 344
Carbidopum, **3**, 63; **5**, 284
Carbo activatus, **2**, 62; **3**, 380
Carbomer, **4**, 151; **5**, 308
Carbomer R, **2**, 288
Carbomerum, **4**, 151; **5**, 308
Carbon dioxide R, **1**, 173
Carbon dioxide detector tube, **5**, 240
Carbon-dioxide-free water R, **1**, 211
Carbon disulfide R, IR, **1**, 173
Carbon monoxide R, **5**, 240
Carbon monoxide detector tube, **5**, 240
Carbon tetrachloride R, **1**, 173
Carbonate-free sodium hydroxide (1 mol/l)
 VS, (0.5 mol/l) VS, (0.2 mol/l) VS,
 (0.1 mol/l) VS, **1**, 205; (0.02 mol/l) VS,
 (0.01 mol/l) VS, **1**, 206
Carboxymethylcellulose R, **3**, 344
Carboxymethylcellulose sodium, *see*
 Carmellose sodium
Carmellose sodium, **4**, 152
Carmellosum natricum, **4**, 152
Carnauba wax, **4**, 158
Category, **2**, 13; **4**, 2
Cellacefate, **4**, 154
Cellacefatum, **4**, 154
Cellacephate, *see* Cellacefate
Cellulose, microcrystalline, **4**, 156
Cellulose R1, R2, R3, **2**, 288
Cellulose acetate phthalate, *see* Cellacefate
Cellulosum microcrystallinum, **4**, 156
Cephalin TS, **5**, 240
Cephaeline hydrochloride R, **3**, 344
Cera carnauba, **4**, 158
Cera cetyla, **4**, 158
Ceric ammonium nitrate R, TS, **1**, 173;
 (0.01 mol/l) VS, **4**, 297
Ceric ammonium sulfate R, (0.1 mol/l) VS, **2**,
 289
Ceric ammonium sulfate/nitric acid TS, **2**,
 289
Ceric sulfate R, (35 g/l) TS, **1**, 174; (0.1 mol/l)
 VS, **3**, 344
Ceruleum methylenum, *see*
 Methylthionium chloride
Cetomacrogol 1000, **4**, 159
Cetomacrogolum 1000, **4**, 159
Cetostearyl alcohol, **4**, 124
Cetrimide, **4**, 161
Cetrimidum, **4**, 161
Cetyl alcohol, **4**, 123

- Cetyl esters wax, **4**, 158
Charcoal, activated, **2**, 62; **3**, 380
Charcoal R, **1**, 174
Chemical formulas, **2**, 10; **4**, 1
Chemical names, **2**, 10; **4**, 2
Chemical reference substances, **4**, 7
 general guidelines for the establishment,
 maintenance, and distribution of, **5**, 328
 see also International Chemical Reference
 Substances
Chewable tablets, **4**, 30
Chloral hydrate, **5**, 57
Chlorali hydras, **5**, 57
Chloralose R, **1**, 144
Chlorambucil, **3**, 65
Chlorambucilum, **3**, 65
Chloramphenicol, **2**, 64
Chloramphenicol RS, **2**, 289
Chloramphenicol disodium disuccinate RS,
 5, 240
Chloramphenicol palmitate, **3**, 67
Chloramphenicol palmitate RS, **3**, 344
Chloramphenicol sodium succinate, **5**, 58
Chloramphenicol sodium succinate RS, **5**, 240
Chloramphenicoli natrii succinas, **5**, 58
Chloramphenicoli palmitas, **3**, 67
Chloramphenicolum, **2**, 64
Chloraniline R, **3**, 344
Chlorbutinum, *see* Chlorambucilum
Chlorhexidine diacetate, **3**, 69
Chlorhexidine dihydrochloride, **3**, 71
Chlorhexidini diacetat, **3**, 69
Chlorhexidini dihydrochloridum, **3**, 71
Chloride standard (5 µg/l) TS, **5**, 240
Chlorides, **1**, 112
 limit test for, **1**, 115
Chlorine, determination of, **1**, 124
Chlorine R, TS, **1**, 174
Chlormethine hydrochloride, **2**, 66
Chlormethini hydrochloridum, **2**, 66
4-Chloroacetanilide R, **3**, 344
Chlorobutanol, **4**, 162
 anhydrous, **4**, 162
 hemihydrate, **4**, 162
Chlorobutanolum, **4**, 162
Chlorocresol, **4**, 164
Chlorocresolum, **4**, 164
7-Chloro-1-cyclopropyl-1,4-dihydro-4-oxo-6-
 (piperazin-1-yl)quinoline-3-carboxylic
 acid RS, **5**, 241
1-Chloro-2,4 dinitrobenzene R, **5**, 241
1-Chloro-2,4 dinitrobenzene/ethanol TS, **5**,
 241
Chloroform R, **1**, 174
 ethanol-free R, **2**, 289
5-Chloro-2-methylaminobenzophenone RS,
 2, 289
2-Chloro-4-nitroaniline R, **2**, 289
Chloroquine phosphate, **2**, 68; **5**, 268
 tablets, **4**, 229; **5**, 311
Chloroquine sulfate, **2**, 70; **5**, 268
 tablets, **4**, 230; **5**, 311
Chloroquine sulfate RS, **4**, 297
Chloroquini phosphas, **2**, 68; **5**, 268
Chloroquini phosphatis compressi, **4**, 229; **5**,
 311
Chloroquini sulfas, **2**, 70; **5**, 268
Chloroquini sulfatis compressi, **4**, 230; **5**, 311
2-(4-Chloro-3-sulfamoyl)benzoic acid RS, **2**,
 290
Chlorphenamine hydrogen maleate, **2**, 72; **5**,
 269
 tablets, **4**, 231
Chlorphenamine hydrogen maleate RS, **2**, 290
Chlorphenamini hydrogenomaleas, **2**, 72; **5**,
 269
Chlorphenamini hydrogenomaleatis
 compressi, **4**, 231
Chlorpheniramine hydrogen maleate *see*
 Chlorphenamine hydrogen maleate
Chlorpromazine hydrochloride, **2**, 74; **5**, 269
Chlorpromazine hydrochloride RS, **2**, 290
Chlorpromazini hydrochloridum, **2**, 74; **5**,
 269
Chlortalidone, **2**, 76
Chlortalidone RS, **2**, 290
Chlortalidonum, **2**, 76
Chlortetracycline hydrochloride, **3**, 73; **5**, 285
Chlortetracycline hydrochloride RS, **2**, 290
Chlortetracyclini hydrochloridum, **3**, 73; **5**,
 284
Cholecalciferol, *see* Colecalciferol
Chromatography, **1**, 79
 column, **1**, 86
 gas, **1**, 90
 high-performance liquid, **3**, 373; **5**, 252,
 257
 high-pressure liquid, **1**, 88
 paper, **1**, 84
 thin-layer, **1**, 80
Chromic acid TS, **2**, 290
Chromium trioxide R, **2**, 290
Chromotropic acid sodium salt, *see* Disodium
 chromotropate
C.I. 14645, *see* Mordant Black 11
C.I. 15705, *see* Calcon
C.I. 42040, *see* Brilliant green
C.I. 42535, *see* Methyl violet 2B
C.I. 42585, *see* Methyl green
C.I. 50040, *see* Neutral red
C.I. Basic green 1, *see* Brilliant green
C.I. Basic red, *see* Neutral red
C.I. Mordant Black 11, *see* Mordant Black 11
C.I. Mordant Black 17, *see* Calcon
Ciclosporin, **5**, 62
Ciclosporin RS, **5**, 241
Ciclosporin U RS, **5**, 241
Ciclosporinum, **5**, 62
Cimetidine, **3**, 76; **5**, 285
Cimetidine RS, **3**, 344
Cimetidinum, **3**, 76; **5**, 285
Cinchonidine R, **2**, 290

- Cinchonine R, **3**, 344
 Ciprofloxacin, **5**, 68
 Ciprofloxacin RS, **5**, 241
 Ciprofloxacin hydrochloride, **5**, 65
 Ciprofloxacin hydrochloride RS, **5**, 241
 Ciprofloxacin hydrochloridum, **5**, 65
 Ciprofloxacinum, **5**, 68
 Cisplatin, **4**, 57
 Cisplatin RS, **4**, 297
 Cisplatinum, **4**, 57
 Citrate buffer, pH 4.0, TS, **4**, 297; pH 5.4, TS, **2**, 290
 Citrates, **1**, 113
 Citric acid, **4**, 110; **5**, 305
 anhydrous, **4**, 110
 copper-free, R, **2**, 290
 monohydrate, **4**, 110
 Citric acid R, FeR, **1**, 174; PbR, **3**, 344;
 (180 g/l) FeTS, **1**, 174; (20 g/l) TS, **2**, 290
 Clarity of solution, **2**, 11; **4**, 4
 Clindamycin hydrochloride RS, **5**, 241
 Clindamycin phosphate, **5**, 71
 Clindamycin phosphate RS, **5**, 241
 Clindamycini phosphas, **5**, 71
 Clofazimine, **3**, 78
 Clofazimine RS, **3**, 345
 Clofaziminum, **3**, 78
 Clomifene citrate, **3**, 80; **4**, 315
 Clomifene citrate RS, **3**, 345
 Clomifene citrate Z-isomer RS, **3**, 345; **5**, 297
 Clomifeni citras, **3**, 80; **4**, 315
 Cloxacillin sodium, **2**, 78; **5**, 269
 capsules, **4**, 224
 powder for injections, **4**, 280; **5**, 311
 Cloxacillin sodium RS, **2**, 290
 Cloxacillini natrici capsulae, **4**, 224
 Cloxacillini natrici pulvis ad injectionem, **4**,
 280; **5**, 311
 Cloxacillinum natricum, **2**, 78; **5**, 269
 Coal tar, **3**, 251
 Coated tablets, **4**, 30
 Cobalt(II) chloride R, (30 g/l) TS, (5 g/l) TS,
 TS, **3**, 345
 Cobalt colour, strong, TS, **1**, 174
 Cobalt(II) nitrate R, (100 g/l) TS, (10 g/l) TS, **3**,
 345
 Cobaltous thiocyanate TS, **2**, 291
 Codeine R, **2**, 291
 Codeine monohydrate, **2**, 80
 Codeine phosphate, **2**, 82
 tablets, **5**, 152
 Codeini phosphas, **2**, 82
 Codeini phosphatis compressi, **5**, 152
 Codeinum monohydricum, **2**, 80
 Coffeinum, **2**, 85
 Colchicine, **3**, 82
 tablets, **5**, 153
 Colchicine RS, **3**, 345; **5**, 241
 Colchicini compressi, **5**, 153
 Colchicinum, **3**, 82
 Colecalciferol, **2**, 87; **4**, 314
 Colecalciferol RS, **2**, 291
 Colecalciferolum, **2**, 87; **4**, 314
 Colour of liquids, **1**, 50
 Colourless solution, **2**, 12; **4**, 5
 Column chromatography, **1**, 86
 Complexometric titrations, **1**, 126
 Congealing point, determination of, **1**, 19
 Congo red paper R, **1**, 175
 Constant weight, **1**, 12
 Containers, ophthalmic preparations, **5**, 7, 10,
 11
 Containers, parenteral preparations, **5**, 27
 Containers, suppositories, **5**, 13
 Containers, **1**, 12; **2**, 12
 hermetically closed, definition of, **2**, 12;
 4, 3
 storage, **4**, 2
 tightly closed, definition of, **1**, 12; **4**, 3
 well-closed, definition of, **1**, 12; **4**, 3
 Content, uniformity of, for single-dose
 preparations, **4**, 46
 Copper(II) acetate R, **2**, 291; (45 g/l) TS, **3**,
 345
 Copper(II) chloride R, **3**, 345
 Copper(II) chloride/ammonia TS, **3**, 345
 Copper colour, strong, TS, **1**, 175
 Copper edetate TS, **2**, 291
 Copper-free citric acid R, **2**, 290
 Copper standard, (10 µg/ml Cu) TS, **3**, 346;
 TS1, TS2, **3**, 346
 Copper(II) sulfate R, (160 g/l) TS, **1**, 175;
 (80 g/l) TS, **2**, 291; (1 g/l) TS, **3**, 346
 Copper(II) sulfate/ammonia TS, **2**, 291
 Copper(II) sulfate/pyridine TS, **2**, 291
 Copper tetramine hydroxide TS, **4**, 297
 Corn starch, *see* Starch
 Cortisol, *see* Hydrocortisone
 Cortisol acetate *see* Hydrocortisone acetate
 Creams, **4**, 43
 hydrophilic (o/w), **4**, 43
 hydrophobic (w/o), **4**, 43
o-Cresol R, **2**, 291
 Cresol red R, **3**, 346
 Cresol red/ethanol TS, **3**, 346
 Crystal violet R, **1**, 175
 Crystal violet/acetic acid TS, **1**, 175
 Culture medium Cm1, Cm2, Cm3, **1**, 175;
 Cm4, Cm5, Cm6, **1**, 176; Cm7, **1**, 177;
 Cm8, Cm9, Cm10, **3**, 346; Cm11, **3**,
 347
 Cyanide/oxalate/thiosulfate TS, **2**, 292
 Cyanocobalamin, **2**, 89
 Cyanocobalaminum, **2**, 89
 Cyanoethylmethyl silicone gum R, **2**, 292
 Cyanogen bromide TS, **2**, 292
 Cyclodolum, *see* Trihexyphenidily
 hydrochloridum
 Cyclohexane R, **1**, 177; R1, **2**, 292
 Cyclophosphamide, **3**, 84
 Cyclophosphamidum, **3**, 84
 Cyclophosphanum, *see* Cyclophosphamidum

1-Cyclopropyl-1,4-dihydro-4-oxo-7-(piperazin-1-yl)quinoline-3-carboxylic acid RS, **5**, 241
L-Cystine R, **1**, 177
Cytarabine, **3**, 86
Cytarabine, RS, **3**, 347
Cytarabinum, **3**, 86

D

Dacarbazine, **5**, 74
 related compound A RS, **5**, 241
 related compound B RS, **5**, 241
Dacarbazine RS, **5**, 241
Dacarbazinum, **5**, 74
Dactinomycin, **4**, 60; **5**, 299
Dactinomycin RS, **4**, 297
Dactinomycinum, **4**, 60; **5**, 299
Dantron R, **5**, 241
Dapsone, **2**, 91
 tablets, **4**, 234
Dapsone RS, **2**, 292
Dapsoni compressi, **4**, 234
Dapsonum, **2**, 91
Deferoxamine mesilate, **3**, 88
Deferoxamini mesilas, **3**, 88
Definitions, **4**, 2
Dehydrated alcohol, *see* Ethanol
Dehydrated ethanol R, **1**, 179
Dehydrated methanol R, **1**, 191
Dehydroemetine dihydrochloride, **3**, 90
Dehydroemetini dihydrochloridum, **3**, 90
Delayed-release, capsules, **4**, 36
 tablets, **4**, 31
Density, mass, relative, determination of, **1**, 27
Desferrioxamine mesylate, *see* Deferoxamine mesilate
Determination of, acid value, **1**, 140
 ash and acid-insoluble ash, **1**, 162
 boiling point, **1**, 19
 boiling range, **1**, 19
 bromine, **1**, 124
 chlorine, **1**, 124
 congealing point, **1**, 19
 fluorine, **1**, 125
 iodine, **1**, 125
 iodine value, **1**, 137
 mass density, **1**, 27
 melting range, **1**, 19
 melting temperature, **1**, 19
 methoxyl, **1**, 135
 nitrogen, **1**, 136
 optical and specific rotation, **1**, 29
 peroxides in fixed oils, **1**, 138
 pH, **1**, 95
 refractive index, **1**, 32
 relative density, **1**, 27
 saponification value, **1**, 139

 sulfur, **1**, 125
 unsaponifiable matter, **1**, 139
 water by the Karl Fischer method, **1**, 134
Dexamethasone, **2**, 95
 tablets, **5**, 155
Dexamethasone RS, **2**, 292
Dexamethasone acetate, **2**, 93; **3**, 380
Dexamethasone acetate RS, **2**, 292
Dexamethasone sodium phosphate, **3**, 91; **5**, 285
Dexamethasone sodium phosphate RS, **3**, 347
Dexamethasoni acetas, **2**, 93; **3**, 380
Dexamethasoni compressi, **5**, 155
Dexamethasoni natrii phosphas, **3**, 347; **5**, 285
Dexamethasonum, **2**, 95
Dextromethorphan hydrobromide, **3**, 94
Dextromethorphan hydrobromide RS, **3**, 347
Dextromethorphanii hydrobromidum, **3**, 94
Dextrose, *see* Glucose
3,3'-Diaminobenzidine tetrahydrochloride R, (5 g/l) TS, **5**, 242
Diammonium hydrogen phosphate R, (100 g/l) TS, **2**, 292
Diatomaceous support R, **3**, 347
Diatrizoate sodium, *see* Sodium amidotrizoate
Diatrizoic acid, *see* Amidotrizoic acid
Diazepam, **2**, 98; **5**, 270
Diazepam RS, **2**, 292
Diazepamum, **2**, 98; **5**, 270
Diazobenzenesulfonic acid TS, **2**, 293
Diazomethane TS, **2**, 293
Diazoxide, **2**, 100
Diazoxide RS, **2**, 292
Diazoxidum, **2**, 100
Dibasic calcium phosphate, *see* Calcium hydrogen phosphate
Dibromomethane R, **1**, 177
Dibutyl ether R, **2**, 293
Dibutyl phthalate R, **2**, 293
Dicaicum, *see* Tetracaini hydrochloridum
Dichloroethane R, **2**, 293
Dichlorofluorescein R, TS, **3**, 347
Dichloromethane R, **1**, 177
2,6-Dichloroquinone chlorimide R, **2**, 293
2,6-Dichloroquinone chlorimide/ethanol TS, **2**, 294
Dichromate colour, strong, TS, **1**, 177
Dicloxacillin sodium, **3**, 96
Dicloxacillin sodium RS, **3**, 347
Dicloxacinum natricum, **3**, 96
Dicoumarol, **2**, 101
Dicoumarol RS, **2**, 294
Dicoumarolum, **2**, 101
Diethoxytetrahydrofuran R, **2**, 294
Diethoxytetrahydrofuran/acetic acid TS, **2**, 294
Diethylamine R, **2**, 294
Diethylaminoethylcellulose R, **3**, 347

- Diethylcarbamazine dihydrogen citrate, **2**, 103
tablets, **4**, 235
- Diethylcarbamazine dihydrogen citrate RS, **2**, 294
- Diethylcarbamazini dihydrogenocitras, **2**, 103
- Diethylcarbamazini dihydrogenocitratis compressi, **4**, 235
- Diethylene glycol R, **1**, 177
- Diethylene glycol succinate R, **2**, 294
- N,N*-Diethyl-*p*-phenylenediamine sulfate R, **5**, 242
- Diethylphenylenediamine sulfate TS, **5**, 242
- Diethyl phthalate R, **3**, 347
- Diethyltoluamide, **5**, 77
- Diethyltoluamide RS, **5**, 242
- Diethyltoluamidum, **5**, 77
- Digitonin R, TS, **2**, 294
- Digitoxin, **2**, 105; **5**, 270
- Digitoxin RS, **2**, 294
- Digitoxinum, **2**, 105; **5**, 270
- Digoxin, **2**, 107; **5**, 270
- Digoxin RS, **2**, 294
- Digoxinum, **2**, 107; **5**, 270
- Dihydroxynaphthalene, *see* Naphthalene-1,3-diol
- Diisopropyl ether R, **4**, 297
- Diloxanide furoate, **3**, 99
tablets, **5**, 157
- Diloxanide furoate RS, **3**, 347
- Diloxanidi furoas, **3**, 99
- Diloxanidi furoatis compressi, **5**, 157
- Dilute acetic acid, *see* Acetic acid
- Dilute arsenic AsTS, **1**, 170
- Dilute glycerol, *see* Glycerol 85% *m/m*
- Dilute hydrochloric acid, **4**, 114
- Dilute lead PbTS, **1**, 187
- Diluted isosorbide dinitrate, **5**, 105
- Dimercaprol, **3**, 100; **5**, 286
- Dimercaprolum, **3**, 100; **5**, 286
- Dimethylacetamide R, **3**, 347
- Dimethylamine R, **2**, 294
- Dimethylamine/ethanol TS, **2**, 295
- 4-Dimethylaminobenzaldehyde R, TS1, TS2, TS3, TS4, **2**, 295; TS5, TS6, **3**, 348
- 4-Dimethylaminocinnamaldehyde R, TS1, TS2, **2**, 295
- N,N*-Dimethylaniline R, **3**, 348
- Dimethyl 2,6-dimethyl-4-(2-nitrophenyl)pyridine-3,5-dicarboxylate RS, **5**, 242
- Dimethyl 2,6-dimethyl-4-(2-nitrosophenyl)pyridine-3,5-dicarboxylate RS, **5**, 242
- Dimethylformamide R, **1**, 178
- N,N*-Dimethyloctylamine R, **5**, 242
- 1,4-Di[2-(4-methyl-5-phenyloxazole)]benzene R, **1**, 178
- Dimethyl-POPOP, *see* 1,4-Di[2-(4-methyl-5-phenyloxazole)]benzene
- Dimethyl sulfoxide R, **3**, 348
- Dinatrii edetas, **4**, 166
- Dinitrobenzene R, **2**, 296
- Dinitrobenzene/ethanol TS, **2**, 296
- 2,4-Dinitrochlorobenzene R, **3**, 348
- Dinitrogen oxide, **5**, 78
- Dinitrogen oxide R, **5**, 242
- Dinitrogenii oxidum, **5**, 78
- Dinonyl phthalate R, **2**, 296
- Dioxan R, **1**, 178
- Diphenoxylate hydrochloride, **3**, 102
- Diphenoxylate hydrochloride RS, **3**, 348
- Diphenoxylati hydrochloridum, **3**, 102
- Diphenylamine R, **2**, 296
- Diphenylamine/sulfuric acid TS, **3**, 348
- Diphenylbenzene, *see p*-Terphenyl R
- Diphenylbenzidine R, **1**, 178
- 1,5-Diphenylcarbazine R, **3**, 348
- Diphenylcarbazine TS, **3**, 348
- Diphenylcarbazono R, **1**, 179
- Diphenylcarbazono/ethanol TS, **1**, 179
- Diphenyl ether R, **1**, 179
- 1,2-Diphenylethylammonium 3-mercapto-2-methylpropanoate RS, **5**, 242
- 2,5-Diphenyloxazole R, **1**, 179
- Dipotassium hydrogen phosphate R, **1**, 179
- Diprazinum, *see* Promethazini hydrochloridum
- Direct inoculation, **4**, 17
- Disintegration test for tablets and capsules, **4**, 40
for suppositories, **5**, 13, 14
- Disodium chromotropate R, **2**, 296; TS, **4**, 298; (10 g/l) TS, **2**, 296
- Disodium edetate, **4**, 166
- Disodium edetate R, **1**, 179; RS, **4**, 298; (50 g/l) TS, **2**, 296; (20 g/l) TS, (10 g/l) TS, **3**, 349; (0.1 mol/l) VS, **2**, 296, **3**, 385; (0.05 mol/l) VS, **1**, 179, **3**, 377; (0.01 mol/l) VS, **3**, 349
- Disodium hydrogen phosphate, anhydrous, R, **1**, 179
- Disodium hydrogen phosphate R, **2**, 296; (100 g/l) TS, **3**, 349; (40 g/l) TS, **2**, 297; (28.4 g/l) TS, **3**, 349
- Dissolution media, **5**, 243
- Dissolution test for solid oral dosage forms, **5**, 18
- 5,5'-Dithiobis 2-nitrobenzoic acid R, **5**, 243
- 5,5'-Dithiobis 2-nitrobenzoic acid/methanol TS, **5**, 244
- Dithizone R, **2**, 297; TS, **3**, 349 standard TS, **3**, 349
- Dithranol, **5**, 86
- Dithranol RS, **5**, 244
- Dithranolum, **5**, 86
- Domiphen bromide R, (10 g/l) TS, **4**, 298
- Dopamine hydrochloride, **3**, 103; **5**, 286
- Dopamine hydrochloride RS, **3**, 349
- Dopamini hydrochloridum, **3**, 103; **5**, 286

Dosage forms, general requirements, **5**, **7**
Dosage forms, monographs, **5**, **309**
Dosage forms, tests for, **5**, **14**
Dosage forms, tests for,
disintegration test for suppositories, **5**, **14**
extractable volume for parenteral
preparations, **5**, **27**
dissolution test for solid oral, **5**, **18**
Doxorubicin hydrochloride, **3**, **105**
Doxorubicin hydrochloride RS, **3**, **349**
Doxorubicini hydrochloridum, **3**, **105**
Doxycycline hyclate, **3**, **107**
tablets, **5**, **159**
Doxycycline hyclate RS, **5**, **244**
Doxycyclini hyclas, **3**, **107**
Doxycyclini hyclatis compressi, **5**, **159**
Dragendorff reagent TS, modified, TS, **4**, **298**
Dried peptone R, **1**, **194**
Drops, ophthalmic, **5**, **9**
Dry-heat sterilization, **4**, **20**
Drying, loss on, **1**, **12**; **2**, **12**; **4**, **5**

E

Econazole nitrate RS, **5**, **244**
Edetate disodium, *see* Disodium edetate
Edrophonii chloridum, **3**, **109**
Edrophonium chloride, **3**, **109**
Effervescent tablets, **4**, **29**
Electrophoresis, **1**, **98**
Emetine hydrochloride, **3**, **111**
Emetine hydrochloride RS, **3**, **349**
Emetini hydrochloridum, **3**, **111**
Emulsions, ophthalmic, **5**, **10**
Endotoxin RS, **5**, **244**
Endotoxins, bacterial, test for, **5**, **30**
Enteric, capsules, **4**, **36**
-coated, tablets, **4**, **31**
Eosin Y R, **3**, **349**; (5 g/l) TS, **3**, **350**
Ephedrine, **3**, **113**
Ephedrine hydrochloride, **3**, **115**
Ephedrine sulfate, **3**, **117**
injection, **4**, **263**
Ephedrine sulfate RS, **4**, **298**
Ephedrini hydrochloridum, **3**, **115**
Ephedrini sulfas, **3**, **117**
Ephedrini sulfatis injectio, **4**, **363**
Ephedrinum, **3**, **113**
4-Epianhydrotetracycline hydrochloride RS, **2**,
297
6-Epidoxycycline hydrochloride RS, **5**, **244**
Epinephrine, **2**, **112**; **3**, **381**; **5**, **271**
Epinephrine hydrogen tartrate, **2**, **110**; **3**, **380**;
5, **270**
Epinephrine hydrogen tartrate R, **2**, **297**
Epinephrini hydrogenotartras, **2**, **110**; **3**, **380**;
5, **270**
Epinephrinum, **2**, **112**; **3**, **381**; **5**, **271**
4-Epitetracycline hydrochloride RS, **2**, **297**

Epsom salt, *see* Magnesium sulfate
heptahydrate
Ergocalciferol, **3**, **119**; **4**, **316**
Ergocalciferol RS, **3**, **350**
Ergocalciferolum, **3**, **119**; **4**, **316**
Ergometrine hydrogen maleate, **2**, **114**; **5**, **271**
injection, **4**, **264**
tablets, **4**, **237**
Ergometrine hydrogen maleate RS, **2**, **297**
Ergometrini hydrogenomaleas, **2**, **114**; **5**, **271**
Ergometrini hydrogenomaleatis compressi, **4**,
237
injectio, **4**, **264**
Ergosterol R, **3**, **350**
Ergotamine tartrate, **2**, **116**; **3**, **381**
Ergotamine tartrate RS, **2**, **297**
Ergotamini tartras, **2**, **116**; **3**, **381**
Eriochrome Black, *see* Mordant Black 11
Eriochrome Black T, *see* Mordant Black 11
Eriochrome Blue Black R, *see* Calcon
Erythromycin, **3**, **121**
Erythromycin RS, **3**, **350**
Erythromycin ethylsuccinate, **3**, **123**; **5**, **286**
tablets, **5**, **161**
Erythromycin ethylsuccinate RS, **3**, **350**
Erythromycin lactobionate, **5**, **90**
Erythromycin lactobionate RS, **5**, **244**
Erythromycin stearate, **3**, **125**
tablets, **5**, **163**
Erythromycin stearate RS, **3**, **350**
Erythromycini ethylsuccinas, **3**, **123**; **5**, **286**
Erythromycini ethylsuccinatis compressi, **5**, **161**
Erythromycini lactobionas, **5**, **90**
Erythromycini stearas, **3**, **125**
Erythromycini stearatis compressi, **5**, **163**
Erythromycinum, **3**, **121**
Eserine salicylate, *see* Physostigmine salicylate
Estrone RS, **2**, **297**
Ethambutol hydrochloride, **2**, **119**
tablets, **5**, **165**
Ethambutol hydrochloride RS, **2**, **297**
Ethambutoli hydrochloridi compressi, **5**, **165**
Ethambutoli hydrochloridum, **2**, **119**
2,2'-(Ethanediylidenedinitrilo)diphenol, *see*
Glyoxal bis(2-hydroxyanil)
Ethanol, **4**, **167**
(95 per cent), *see* Ethanol (~750 g/l) TS
aldehyde-free, (95 per cent), *see* Ethanol
(~750 g/l), aldehyde-free, TS
Ethanol, dehydrated, R, **1**, **179**; neutralized,
TS, **2**, **297**; (~750 g/l) TS, **1**, **179**;
(~750 g/l), aldehyde-free, TS, **2**, **297**;
(~750 g/l), sulfate-free, TS, (~710 g/l) TS,
1, **180**; (~675 g/l) TS, (~600 g/l) TS, **2**,
297; (535 g/l) TS, (457 g/l) TS, **4**, **298**;
(~375 g/l) TS, (~150 g/l) TS, **1**, **180**
Ethanolum, **4**, **167**
Ether, anaesthetic, **3**, **128**
Ether R, **1**, **179**
diphenyl, R, **1**, **179**
peroxide-free, R, **4**, **298**

Ether anaesthetic, **3**, 128
 Ethinylestradiol, **2**, 121
 Ethinylestradiol RS, **2**, 297
 Ethinylestradiolum, **2**, 121
 Ethionamide, **3**, 129
 Ethionamide RS, **3**, 350
 Ethionamidum, **3**, 129
 Ethosuximide, **2**, 123; **3**, 381
 Ethosuximide RS, **2**, 297
 Ethosuximidum, **2**, 123; **3**, 381
 Ethyl acetate R, **1**, 180
 Ethyl alcohol, *see* Ethanol
 Ethyl aminobenzoate, *see* Benzocaine
 Ethyl hydroxybenzoate, **4**, 170
 Ethyl iodide R, **2**, 298
 Ethylcellulose, **4**, 169
 Ethylcellulosum, **4**, 169
 Ethylenediamine R, **2**, 298
 Ethylene glycol monoethyl ether R, **1**, 180
 Ethylene glycol monomethyl ether R, **3**, 350
 Ethylene oxide R, TS, **5**, 244
 stock solution R, **5**, 244
 Ethylis hydroxybenzoas, **4**, 170
 Ethylmethylketone R, **2**, 298
 Ethylparaben, *see* Ethyl hydroxybenzoate
 1-Ethylquinaldinium iodide R, (15 g/l) TS, **5**, 245
 Etoposide, **5**, 92
 Etoposide RS, **5**, 245
 Etoposidum, **5**, 92
 Examination in ultraviolet light, **2**, 12; **4**, 4
 Excipients, monographs for **4**, 105; **5**, 305
 Exposure to ionizing radiation, **4**, 21
 Extended-release capsules, **4**, 35
 tablets, **4**, 31
 Extractable volume for parenteral preparations, test for, **5**, 27

F

Fat, hard, **4**, 120
 Ferric ammonium sulfate R, (45 g/l) TS **1**, 180; TS1, TS2, **2**, 298; (0.1 mol/l) VS, **3**, 350
 Ferric chloride R, (25 g/l) TS, **1**, 180; (65 g/l) TS, **3**, 350; (50 g/l) TS **3**, 351
 Ferric chloride/ferricyanide/arsenite TS, **3**, 351
 Ferric chloride/potassium ferricyanide TS, **3**, 351
 Ferricyanide standard (50 µg/ml) TS, **3**, 351
 Ferrocyanide standard (100 µg/ml) TS, **3**, 351
 Ferroin TS, **4**, 298
 Ferrosi fumaras, **3**, 131
 Ferrosi sulfas, **2**, 125
 Ferrous ammonium sulfate R, (1 g/l) TS, **1**, 180; (0.1 mol/l) VS, **4**, 299
 Ferrous fumarate, **3**, 131
 Ferrous salts, **1**, 113

Ferrous sulfate, **2**, 125
 Ferrous sulfate R, (15 g/l) TS, **1**, 180; (7 g/l) TS, **4**, 299; (0.1 mol/l) VS, **1**, 180
 Ferrous sulfate/hydrochloric acid TS, **5**, 245
 Film-coated tablets, **4**, 31
 Filtration, membrane, **4**, 16
 sterilization by, **4**, 21
 Firebrick, pink, R, **2**, 298
 Flucloxacillin sodium RS, **4**, 299
 Flucytosine, **3**, 133; **5**, 286
 Flucytosine RS, **3**, 351
 Flucytosinum, **3**, 133; **5**, 286
 Fludrocortisone acetate, **3**, 135
 Fludrocortisone acetate RS, **3**, 351
 Fludrocortisoni acetas, **3**, 135
 Fluorescein sodium, **3**, 138; **5**, 287
 Fluoresceinum natricum, **3**, 138; **5**, 287
 Fluorescence spectrophotometry, **1**, 45
 Fluorine, determination of, **1**, 125
 Fluoroquinolonic acid RS, **5**, 245
 Fluorouracil, **3**, 141; **5**, 287
 Fluorouracil RS, **3**, 351
 Fluorouracilum, **3**, 141; **5**, 287
 Fluphenazine decanoate, **2**, 127; **5**, 271
 Fluphenazine decanoate RS, **2**, 298
 Fluphenazine enantate, **2**, 129; **5**, 272
 Fluphenazine enantate RS, **2**, 298
 Fluphenazine hydrochloride, **2**, 131
 Fluphenazine hydrochloride RS, **2**, 298
 Fluphenazini decanoas, **2**, 127; **5**, 271
 Fluphenazini enantas, **2**, 129; **5**, 272
 Fluphenazini hydrochloridum, **2**, 131
 Folic acid, **2**, 24
 Folic acid RS, **2**, 298
 Formaldehyde TS, **2**, 298
 Formaldehyde/sulfuric acid TS, **2**, 298
 Formamide R, **2**, 298
 Formic acid, *see* Formic acid (~1080 g/l) TS
 Formic acid, anhydrous, R, **2**, 299
 Formic acid (~1080 g/l) TS, **1**, 181
 Formulas, chemical, **2**, 10
 3-Formylrifamycin SV RS, **3**, 351
 Fradiomycini sulfas, *see* Neomycini sulfas
 Framycetin sulfate RS, **3**, 357; **5**, 297
 Fuchsin, basic, R, TS, **2**, 299
 decolorized, TS, **3**, 351
 Fuchsin/sulfurous acid TS, **4**, 299
 Furadonium, *see* Nitrofurantoinum
 Furosemide, **2**, 133; **5**, 272
 Furosemide RS, **2**, 299
 Furosemidum, **2**, 133; **5**, 272

G

Gallamine triethiodide, **3**, 143
 Gallamine triethiodide RS, **3**, 352
 Gallamini triethiodidum, **3**, 143
 Gamma benzene hexachloride, *see* Lindane
 Gammahexachlorcyclohexane, *see* Lindane

Gas sterilization, **4**, 22
Gastric intestinal fluid, simulated, TS, **5**, 243
Gelatin, **4**, 172
Gelatin R, TS, **1**, 181
Gelatina, **4**, 172
Gels, **4**, 43
 hydrophilic, **4**, 44
 hydrophobic, **4**, 44
General guidelines for the establishment, maintenance, and distribution of chemical reference substances, **5**, 328
General identification tests, **1**, 111
General notices, **1**, 10; **2**, 10; **4**, 1; **5**, 1, 297
General principles for guidance in devising International Nonproprietary Names (INN) for pharmaceutical substances, **5**, 317
General requirements, **4**, 13; **5**, 297
 for dosage forms, **4**, 25; **5**, 7
 microbial purity, **5**, 29
 for substances, **4**, 25
 tests and methods, **4**, 13
Gentamicin sulfate, **3**, 145; **5**, 287
Gentamicin sulfate RS, **3**, 352
Gentamicini sulfas, **3**, 145; **5**, 287
Glacial acetic acid R, **1**, 168; R1, **2**, 279
Glauber's salt, *see* Sodium sulfate
Glibenclamide, **3**, 147; **4**, 316
Glibenclamide RS, **3**, 352
Glibenclamidum, **3**, 147; **4**, 316
Glucose, **2**, 135; **3**, 381; **5**, 272
Glucose, anhydrous, R, **3**, 352
 hydrate, R, **1**, 181
Glycerin, *see* Glycerol
Glucosum, **2**, 135; **3**, 381; **5**, 272
Glycerol, **4**, 167
Glycerol R, **1**, 181
Glycerol, dilute, *see* Glycerol 85% *m/m*
Glycerol 85% *m/m*, **4**, 178
Glyceroli monostearas, **4**, 174
Glycerolum, **4**, 176
Glycerolum 85% *m/m*, **4**, 178
Glyceryl monostearate, **4**, 174
Glyceryl trinitrate tablets, **4**, 239
Glycerylis trinitratis compressi, **4**, 239
Glycine R, **5**, 245
Glyoxal bis(2-hydroxyanil) R, TS, **1**, 182
Graphic representation of chemical formulae in the publications of International Nonproprietary Names (INNs) for pharmaceutical substances, **5**, 317
Granulated zinc AsR, **1**, 211
Green stock standard TS, **1**, 182
Griseofulvin, **2**, 137
 tablets, **4**, 241
Griseofulvin RS, **2**, 299
Griseofulvini compressi, **4**, 241
Griseofulvinum, **2**, 137
Guidelines, general, for the establishment, maintenance, and distribution of chemical reference substances, **5**, 328

Guidelines for the graphic representation of chemical formulae, **5**, 317
Gummi arabicum, **4**, 181

H

Haloperidol, **2**, 139; **5**, 272
Haloperidol RS, **2**, 299
Haloperidolum, **2**, 139; **5**, 272
Halothane, **2**, 141
Halothanum, **2**, 141
Hard capsules, **4**, 33
Hard fat, **4**, 120
Hard paraffin, **4**, 199
Heating in an autoclave, **4**, 19
Heavy metals, limit test for, **1**, 121
Helium R, **1**, 182
Heparin calcium, **5**, 95
Heparinum calcium, **5**, 95
Heparinum natrium, **5**, 99
Heparin sodium, **5**, 99
Heparin RS, **5**, 246
Heparinized saline TS, **1**, 182
Heptane R, **3**, 352
Hermetically closed containers, definition of, **2**, 12; **4**, 3
Hexamethyldisilazane R, **3**, 352
Hexamethylene, *see* Cyclohexane
Hexamethylenetetramine, *see* Methenamine
Hexane R, **2**, 299
Hexylamine R, **5**, 246
High-performance liquid chromatography, **3**, 373; **5**, 257
 Supports for, **5**, 252
High-pressure liquid chromatography, **1**, 88
Histamine, strong, TS, **1**, 182
Histamine dihydrochloride R, **1**, 182
Histamine-like substances, test for, **1**, 156
Histamine phosphate R, **1**, 183
Holmium oxide R, **1**, 183
Holmium perchlorate TS, **1**, 183
Homatropine hydrobromide, **3**, 149
Homatropine methylbromide, **4**, 63
Homatropini hydrobromidum, **3**, 149
Homatropini methylbromidum, **4**, 63
Hydralazine hydrochloride, **3**, 150
Hydralazini hydrochloridum, **3**, 150
Hydrargyri oxycyanidum, **2**, 143
Hydrated calcium chloride R, **1**, 172
Hydrazine hydrate R, **2**, 300
Hydrazine sulfate R, **3**, 352
Hydriodic acid, *see* Hydriodic acid (~970 g/l) TS
Hydriodic acid (~970 g/l) TS, **1**, 183
Hydrochloric acid, **4**, 112
Hydrochloric acid, brominated, AsTS, **2**, 300;
 ClTS, **1**, 184; (~420 g/l) TS, **1**, 183;
 (~330 g/l) TS, **3**, 352; (~250 g/l) TS,
 (~250 g/l) AsTS, **1**, 183; (~250 g/l) FeTS, **2**,

- 300; (~250 g/l), stannated, AsTS, (~70 g/l) TS, **1**, 184; (5 mol/l), **2**, 300; (2 mol/l) VS, (1 mol/l) VS, (0.5 mol/l) VS, **1**, 184; (0.2 mol/l) VS, **2**, 300; (0.1 mol/l) VS, **1**, 184; (0.05 mol/l) VS, **3**, 352; (0.02 mol/l) VS, **2**, 300; (0.015 mol/l) VS, (0.01 mol/l) VS, **1**, 185; (0.005 mol/l) VS, **3**, 353; (0.001 mol/l) VS, **2**, 300; (0.0001 mol/l) VS, **3**, 353
- Hydrochloric acid, dilute, **4**, 114
- Hydrochloric acid, saturated, *see* Hydrochloric acid (~420 g/l) TS
- Hydrochloric acid (0.1 mol/l) LAL, **5**, 246
- Hydrochloric acid/ethanol (1 mol/l) VS, **5**, 246, (0.1 mol/l) VS, **5**, 246
- Hydrochloric acid/methanol (0.5 mol/l) VS; (0.01 mol/l) VS, **3**, 353
- Hydrochlorothiazide, **2**, 145
- Hydrochlorothiazide RS, **2**, 301
- Hydrochlorothiazidum, **2**, 145
- Hydrocortisone, **2**, 149
- Hydrocortisone R, RS, **2**, 301
- Hydrocortisone acetate, **2**, 147
- Hydrocortisone acetate RS, **2**, 301
- Hydrocortisone sodium succinate, **3**, 152; **5**, 288
- Hydrocortisone sodium succinate RS, **3**, 353
- Hydrocortisoni acetas, **2**, 147
- Hydrocortisoni natrii succinas, **3**, 152; **5**, 288
- Hydrocortisonum, **2**, 149
- Hydrogen peroxide (30 per cent), *see* Hydrogen peroxide (~330 g/l) TS
- Hydrogen peroxide (~330 g/l) TS, **2**, 301; (~60 g/l) TS, **1**, 185
- Hydrogen sulfide R, TS, **1**, 185
- Hydrophilic creams (o/w), **4**, 43
gels, **4**, 44
ointments, **4**, 44
- Hydrophobic creams (w/o), **4**, 43
gels, **4**, 44
ointments, **4**, 44
- Hydroquinone R, **3**, 353
- Hydrous benzoyl peroxide, **5**, 51
- Hydrous benzoyl peroxide R, **5**, 239
- Hydrous wool fat, **4**, 118
- Hydroxocobalamin, **3**, 154; **5**, 288
- Hydroxocobalamin chloride, **3**, 158
- Hydroxocobalamin sulfate, **3**, 158
- Hydroxocobalamini chloridum, **3**, 158
- Hydroxocobalamini sulfas, **3**, 158
- Hydroxocobalaminum, **3**, 154; **5**, 288
- 1-Hydroxy-9-anthrone RS, **5**, 246
- Hydroxyethylcellulose, **4**, 182
- Hydroxyethylcellulose R, TS, **2**, 301
- Hydroxyethylcellulosum, **4**, 182
- Hydroxylamine hydrochloride R, **2**, 302; TS, **4**, 299; (~200 g/l) TS, **3**, 353; (70 g/l) TS, **4**, 299, TS2, **5**, 246
- Hydroxyl value, **4**, 25
- (-)-3-(4-Hydroxy-3-methoxyphenyl)-2-hydrazino-2-methylalanine RS, **3**, 353
- (-)-3-(4-Hydroxy-3-methoxyphenyl)-2-methylalanine RS, **2**, 302
- Hydroxypropylcellulose, **4**, 184
- Hydroxypropylcellulosum, **4**, 184
- Hydroxypropylmethylcellulose, *see* Hypromellose
- Hypromellose
- 8-Hydroxyquinoline R, **4**, 299
- 8-Hydroxyquinoline/chloroform TS, **4**, 299
- Hypophosphorous acid R, dilute, TS, **4**, 300
- Hypoxanthine R, **4**, 300
- Hypromellose, **4**, 185
- Hypromellosum, **4**, 185

I

- Ibuprofen, **2**, 151
tablets, **5**, 167
- Ibuprofen RS, **2**, 302
- Ibuprofeni compressi, **5**, 167
- Ibuprofenum, **2**, 151
- Identification tests, general, **1**, 111
- Identity tests, **2**, 11; **4**, 4
- Idoxuridine, **5**, 102
- Idoxuridine RS, **5**, 246
- Idoxuridinum, **5**, 102
- Imidazole R, crystallized, R, **2**, 302
- Imidazole/mercuric chloride TS, **2**, 302
- Iminodibenzyl R, **3**, 353
- Imipramine hydrochloride, **4**, 65
- Imipramine hydrochloride RS, **4**, 300
- Imipramini hydrochloridum, **4**, 65
- Imizine, *see* Imipramine hydrochloride
- Implants, **4**, 40
- Impurities, **2**, 11
- Indicator paper R, pH, **3**, 353
- Indicators, visual determination of pH values, **2**, 12; **4**, 5
- Indometacin, **2**, 154
tablets, **5**, 168
- Indometacin RS, **2**, 302
- Indometacini compressi, **5**, 168
- Indometacinum, **2**, 154
- Information, additional, **4**, 3
labelling, **4**, 3
stability, **4**, 3
supplementary, **5**, 315
- Infrared Reference Spectra, International, **5**, 326
- Infusions, intravenous, **4**, 40
parenteral, extractable volume for, **5**, 28
- Injections, **4**, 69, 263
extractable volume for, **5**, 27
- Injections, particulate matter inspection, **5**, 33
powders for, **4**, 40, 273
- Inoculation, direct, **4**, 17
- Insulin, **4**, 67
- Insulinum, **4**, 67
- International Chemical Reference Substances, **1**, 165; **4**, 7

list of, **5**, 319
 International Infrared Reference Spectra, list of, **5**, 326
 International Nonproprietary Names (INN) for pharmaceutical substances, general principles for guidance in devising, **5**, 317
 graphic representation of chemical formulae in the publications of, **5**, 317
 procedure for the selection of, **5**, 317
 Intestinal fluid, simulated, TS, **5**, 243
 Intravenous infusions, **4**, 40
 Iodide standard (20 µg I/ml) TS, **4**, 300
 Iodides, **1**, 113
 Iodine, **2**, 156; **5**, 273
 determination of, **1**, 125
 Iodine R, **1**, 185; TS, (0.1 mol/l) VS, **1**, 185, **3**, 377, **4**, 317; (0.05 mol/l) VS, **3**, 354, **4**, 317; (0.02 mol/l) VS, **1**, 185, **3**, 378, **4**, 317; (0.01 mol/l) VS, **1**, 185, **3**, 378, **4**, 317; (0.005 mol/l) VS, **3**, 354, **4**, 317; (0.0005 mol/l) VS, **4**, 300; (0.0001 mol/l) VS, **3**, 354, **4**, 317
 Iodine bromide R, **1**, 185; TS, **1**, 186
 Iodine/chloroform TS, **3**, 354
 Iodine/ethanol TS, **2**, 302
 Iodine pentoxide R, **5**, 247
 Iodine value, determination of, **1**, 137
 Iodum, **2**, 156; **5**, 273
 Iohexol, **4**, 68; **5**, 299
 Iohexol RS, **4**, 300
 Iohexolum, **4**, 68; **5**, 299
 Ionizing radiation, exposure to, **4**, 21
 Iopanoic acid, **4**, 53; **5**, 298
 Iopanoic acid RS, **4**, 300
 Iotroxic acid, **4**, 100; **5**, 304
 Iotroxic acid RS, **4**, 300
 Ipecacuanha root, **3**, 161
 Ipecacuanhae radix, **3**, 161
 Iron, limit test for, **1**, 120
 reduced R, **4**, 300
 Iron colour, strong, TS, **1**, 186; TS, **1**, 186
 Iron salicylate TS, **3**, 354
 Iron standard FeTS, **1**, 186
 Isobutyl methyl ketone R, **4**, 300
 Isoniazid, **2**, 157
 tablets, **5**, 170
 Isoniazid R, TS, **4**, 300; RS, **2**, 302
 Isoniazidi compressi, **5**, 170
 Isoniazidum, **2**, 157
 Isonicotinic acid hydrazide, *see* Isoniazid
 Isoprenaline hydrochloride, **2**, 159; **3**, 382; **5**, 273
 Isoprenaline sulfate, **2**, 161; **3**, 382; **5**, 273
 Isoprenalini hydrochloridum, **2**, 159; **3**, 382; **5**, 273
 Isoprenalini sulfas, **2**, 161; **3**, 382; **5**, 273
iso-Propanol, *see* 2-Propanol R
 Isopropyl alcohol, *see* 2-Propanol R
 Isopropyl ether, *see* Diisopropyl ether R
 Isopropylamine R, **3**, 354

Isosorbide dinitrate, diluted, **5**, 105
 Isosorbidi dinitras dilutus, **5**, 105

K

Kalii chloridum, **2**, 163; **3**, 382; **5**, 273
 Kalii citras, **3**, 164
 Kalii iodidum, **2**, 165; **3**, 382
 Kanamycin monosulfate RS, **4**, 300
 Kaolin, **4**, 186
 Kaolin, light, R, suspension TS, **5**, 247
 Kaolinum, **4**, 186
 Karl Fischer reagent TS, **1**, 186
 Ketamine hydrochloride, **4**, 71; **5**, 300
 Ketamine hydrochloride RS, **4**, 300
 Ketamini hydrochloridum, **4**, 71; **5**, 300
 Ketoconazole, **5**, 108
 Ketoconazole RS, **5**, 247
 Ketoconazolum, **5**, 108
 Kieselguhr R1, **2**, 302; R2, R3, R4, R5, **2**, 303

L

Labelling information, **4**, 3
 Labelling information, ophthalmic preparations, **5**, 8
 Labelling information, suppositories, **5**, 13
 Lactic acid, **4**, 115; **5**, 305
 Lactobionic acid R, **5**, 247
 Lactose, **4**, 188; **5**, 308
 anhydrous, **4**, 188
 monohydrate, **4**, 188
 Lactosum, **4**, 188; **5**, 308
 Lanolin, *see* Wool fat
 anhydrous, *see* Wool fat
 Lanthanum nitrate (30 g/l) TS, **1**, 187
 Lead, by complexometry, **1**, 129
 dilute, PbTS, **1**, 187,
 strong, PbTS, **1**, 187
 Lead acetate R, (80 g/l) TS, **1**, 187
 Lead acetate paper R, **3**, 354
 Lead nitrate, paper, R, **4**, 301; R, **1**, 187;
 (100 g/l) TS, **3**, 354; (0.1 mol/l) VS, **4**, 300;
 (0.05 mol/l) VS, **1**, 187
 Lead(IV) oxide, R, **3**, 355
 Lead subacetate TS, **4**, 301
 Leucovorin calcium, *see* Calcium folinate
 Levamisole hydrochloride, **5**, 110
 Levamisole hydrochloride RS, **5**, 247
 Levamisoli hydrochloridum, **5**, 110
 Levarterenol hydrogen tartrate R, **2**, 303;
 3, 385
 Levodopa, **2**, 167
 Levodopa RS, **2**, 303
 Levodopum, **2**, 167
 Levonorgestrel, **3**, 166
 Levonorgestrel RS, **3**, 355
 Levonorgestrelum, **3**, 166
 Levothyroxine sodium, **3**, 168

- Levothyroxine sodium RS, **3**, 355
 Levothyroxinum natricum, **3**, 168
 Lidocaine, **2**, 171
 Lidocaine RS, **2**, 303
 Lidocaine hydrochloride, **2**, 169; **5**, 274
 Lidocaini hydrochloridum, **2**, 169; **5**, 274
 Lidocainum, **2**, 171
 Light, protection from, **1**, 12; **4**, 3
 Light petroleum R, **1**, 195; R1, **2**, 307
 Limit test, arsenic, **1**, 121
 chlorides, **1**, 111
 heavy metals, **1**, 117
 iron, **1**, 120
 sulfates, **1**, 116
 Limulus amoebocyte lysate (LAL), **5**, 247
 Lincomycin hydrochloride RS, **5**, 247
 Lindane, **2**, 173; **3**, 382
 Lindane RS, **2**, 303
 Lindanum, **2**, 173; **3**, 382
 Liothyronine RS, **3**, 355
 Liquid chromatography, high performance, **3**, 373; **5**, 252, 257
 Liquid paraffin R, **1**, 192
 List of available International Chemical Reference Substances, **5**, 319
 List of International Infrared Reference Spectra, **5**, 326
 List of reagents, test solutions, and volumetric solutions, **1**, 167; **2**, 279; **3**, 337; **4**, 293; **5**, 235, 280, 296, 314
 Lithii carbonas, **2**, 175
 Lithium R, **2**, 303
 Lithium carbonate, **2**, 175
 Lithium carbonate R, **3**, 355
 Lithium carbonate/trinitrophenol TS, **3**, 355
 Lithium chloride R, (10 g/l) TS, **3**, 355
 Lithium methoxide (0.1 mol/l) VS, **2**, 304; **3**, 386
 Lithium perchlorate R, **1**, 188
 Lithium perchlorate/acetic acid TS, **1**, 188
 Litmus R, TS, **2**, 304
 Litmus paper R, **2**, 304
 Loperamide hydrochloride, **3**, 170
 Loperamide hydrochloride RS, **3**, 355
 Loperamidi hydrochloridum, **3**, 170
 Loss on drying, **1**, 12; **2**, 12; **4**, 5
- M**
 Macrogol 1000 R, **3**, 355; 400 R, **1**, 188; 200 R, **5**, 247; 20M R, **2**, 304; 200 TS, **5**, 247
 Macrogol *p*-isooctylphenyl ether R, **3**, 355
 Magenta, basic, *see* Fuchsin, basic
 Magnesii hydroxidum, **3**, 172
 Magnesii oxidum, **3**, 174
 Magnesii stearas, **4**, 190
 Magnesii sulfatis heptahydras, **4**, 73; **5**, 300
 Magnesium, by complexometry, **1**, 129
 Magnesium (0.1 mg/ml Mg) TS, **3**, 356
 Magnesium acetate R, **3**, 355
 Magnesium aluminosilicate, *see* Aluminium magnesium silicate
 Magnesium chloride R, (0.1 mol/l) VS, **3**, 355
 Magnesium hydroxide, **3**, 172
 Magnesium oxide, **3**, 174
 Magnesium oxide R, **1**, 169
 Magnesium standard (10 µg/ml Mg) TS, **3**, 356
 Magnesium stearate, **4**, 190
 Magnesium sulfate R, **1**, 189; (50 g/l) TS, **2**, 304
 Magnesium sulfate heptahydrate, **4**, 73; **5**, 300
 Magnesium sulfate/sulfuric acid TS, **3**, 356
 Malachite green G, *see* Brilliant green
 Maleic acid R, **4**, 301
 Manganese dioxide R, **1**, 189
 Manganese/silver paper R, **1**, 189
 Manganese sulfate R, (15 g/l) TS, **1**, 190
 Mannitol, **2**, 177; **3**, 383; **5**, 274
 Mannitolum, **2**, 177; **3**, 383; **5**, 274
 Mass, uniformity of, for single-dose preparations, **4**, 47
 density and relative density, **1**, 27
 measurement of, **1**, 17
 Mebendazole, **3**, 176
 tablets, **4**, 243; **5**, 311
 Mebendazole RS, **3**, 356
 Mebendazoli compressi, **4**, 243; **5**, 311
 Mebendazolium, **3**, 176
 Medroxyprogesterone acetate, **4**, 75; **5**, 300
 Medroxyprogesterone acetate RS, **4**, 301
 Medroxyprogesteroni acetas, **4**, 75; **5**, 300
 Mefloquine hydrochloride, **5**, 228
 Mefloquine hydrochloride RS, **5**, 247
 Mefloquini hydrochloridum, **5**, 228
 Meglumine, **4**, 103; **5**, 305
 Meglumine R, (100 g/l) TS, **4**, 301
 Megluminum, **4**, 103; **5**, 305
 Melarsoprol injection, **4**, 266
 Melarsoprol injectio, **4**, 266
 Melting range, determination of, **1**, 19
 Melting temperature, determination of, **1**, 19
 Membrane filtration, **4**, 16
 Menadione R, **3**, 356
 Meperidine hydrochloride, *see* Pethidine hydrochloride
 Mercaptoacetic acid R, **1**, 190
 Mercaptopurine, **4**, 77
 Mercaptopurinum, **4**, 77
 Mercuric acetate R, **1**, 190
 Mercuric acetate/acetic acid TS, **1**, 190
 Mercuric bromide R, AsTS, paper AsTS, **1**, 190
 Mercuric chloride R, (65 g/l) TS, (2.7 g/l) TS, **2**, 304
 Mercuric chloride/ethanol TS, **3**, 356
 Mercuric iodide R, **4**, 301
 Mercuric nitrate R, **1**, 190; TS, (0.02 mol/l) VS, **3**, 356; (0.01 mol/l) VS, **1**, 190
 Mercuric oxide, yellow, R, **1**, 191
 Mercuric oxycyanide, **2**, 143

- Mercuric sulfate TS, **1**, 191
Mercury R, **2**, 304
Mercury/nitric acid TS, **3**, 356
Metacycline hydrochloride RS, **5**, 247
Methanol R, dehydrated, R, **1**, 191
Methenamine R, **1**, 191
DL-Methionine, **5**, 112
DL-Methionine RS, **5**, 247
DL-Methioninum, **5**, 112
Methotrexate, **3**, 178; **5**, 288
Methotrexate RS, **3**, 357
Methotrexatum, **3**, 357; **5**, 288
Methoxyl, determination of, **1**, 135
Methyl alcohol, *see* Methanol
Methyl green R, **4**, 301
Methyl green/iodomercurate paper R, **4**, 302
Methyl hydroxybenzoate, **4**, 193
Methyl orange R, **1**, 191
Methyl orange/acetone TS, **2**, 304
Methyl orange/ethanol TS, **1**, 191
Methyl red R, **1**, 191
Methyl red/ethanol TS, **1**, 191
Methyl red/methylthionium chloride TS, **1**, 192
Methyl silicone gum R, **2**, 305
Methyl violet 2B R, **5**, 247
Methylamine hydrochloride R, (20 g/l) TS, **4**, 301
Methylcellulose, **4**, 192
Methylcellulosum, **4**, 192
Methylcyanide, *see* Acetonitrile
Methyldopa, **2**, 179
Methyldopa RS, **2**, 304
Methyldopum, **2**, 179
Methylene blue, *see* Methylthionium chloride
Methylene bromide, *see* Dibromomethane
Methylene chloride, *see* Dichloromethane
Methylis hydroxybenzoas, **4**, 193
Methylisobutylketone R, **2**, 304
2-Methyl-5-nitroimidazole R, **4**, 302
N-Methyl-N-nitrosotoluene-4-sulfonamide R, **2**, 304
Methylparaben, *see* Methyl hydroxybenzoate
N-Methylpiperazine R, **2**, 305
Methylrosanilini chloridum, **5**, 114
Methylrosanilinium chloride, **5**, 114
Methyltestosterone, **2**, 181
Methyltestosterone RS, **2**, 305
Methyltestosteronum, **2**, 181
Methylthioninii chloridum, **3**, 180; **5**, 289
Methylthioninium chloride, **3**, 180; **5**, 289
Methylthioninium chloride R, **1**, 192; (1 g/l) TS, **2**, 305; (0.2 g/l) TS, **1**, 192
Methylthymol blue R, **2**, 305
Methylthymol blue mixture R, **2**, 305
Metoclopramide hydrochloride, **3**, 182; **5**, 289
Metoclopramide hydrochloride RS, **3**, 357
Metoclopramidi hydrochloridum, **3**, 182; **5**, 289
Metrifonate, **3**, 184
Metrifonatum, **3**, 184
Metronidazole, **2**, 183; **5**, 275
tablets, **4**, 245
Metronidazole RS, **2**, 305
Metronidazole benzoate, **5**, 117
Metronidazole benzoate RS, **5**, 248
Metronidazole injection, **4**, 268
Metronidazoli benzoas, **5**, 117
Metronidazoli compressi, **4**, 245
injectio, **4**, 268
Metronidazolium, **2**, 183; **5**, 275
Miconazole nitrate, **3**, 186
Miconazole nitrate RS, **3**, 357
Miconazoli nitras, **3**, 186
Microbial purity of pharmaceutical preparations, **5**, 28
Microbiological assay of antibiotics, **1**, 145; **3**, 377
Microcrystalline cellulose, **4**, 156
Modified-release capsules, **4**, 35
tablets, **4**, 31
Molecular mass, relative, **4**, 1
Molybdenum trioxide R, **3**, 357
Monoethanolamine R, **3**, 357
Monoethanolamine (0.1 mol/l) VS, **5**, 248
Monograph nomenclature, **2**, 10; **4**, 1
Monographs, for antimalarial drugs, **5**, 185
for dosage forms, **4**, 217; **5**, 309
for excipients, **4**, 105; **5**, 305
for pharmaceutical substances, **2**, 17; **3**, 15; **4**, 51; **5**, 37, 298
Monographs, for tablets, **5**, 147
Mordant Black 11 R, **1**, 192
Mordant Black 11 indicator mixture R, **1**, 192
Mordant Black 17, *see* Calcon
Morphine hydrochloride, **2**, 185; **5**, 275
Morphine sulfate, **2**, 187; **5**, 275
tablets, **5**, 171
Morphini hydrochloridum, **2**, 185; **5**, 275
Morphini sulfas, **2**, 187; **5**, 275
Morphini sulfatis compressi, **5**, 171
Morpholine R, **4**, 302
Myelosanum, *see* Busulfanum

N

- Nagananinum, *see* Suramin sodium
Naloxone hydrochloride, **3**, 188; **5**, 289
Naloxone hydrochloride RS, **3**, 357
Naloxoni hydrochloridum, **3**, 188; **5**, 289
Names, chemical, **2**, 10
symbols, and relative atomic masses of elements, **1**, 166
Naphthalene-1,3-diol R, **4**, 302
Naphthalene-1,3-diol/ethanol TS, **4**, 302
1-Naphthol R, TS1, **2**, 305
1-Naphthol/ethanol TS, **4**, 302
2-Naphthol R, TS1, **1**, 192
 β -Naphthol, *see* 2-Naphthol
1-Naphtholbenzein R, **2**, 305

- 1-Naphtholbenzein/acetic acid TS, **2**, 305
 Naphthoresorcinol, *see* Naphthalene-1,3-diol
N-(1-Naphthyl)ethylenediamine/ethanol TS, **5**, 280
N-(1-Naphthyl)ethylenediamine hydrochloride R, **2**, 305; (5 g/l) TS, (1 g/l) TS, **2**, 306
N-(1-Naphthyl)ethylenediamine hydrochloride/ethanol TS, **2**, 306; **5**, 280
N-(1-Naphthyl)ethylenediamine hydrochloride/1-propanol TS, **4**, 302
N-(1-Naphthyl)ethylenediamine hydrochloride/propylene glycol TS, **4**, 302
 Natrii amidotrizoas, **4**, 79
 Natrii calcii edetas, **3**, 190; **5**, 290
 Natrii chloridum, **2**, 189; **5**, 275
 Natrii citras, **3**, 192
 Natrii cromoglicas, **3**, 194
 Natrii fluoridum, **3**, 196
 Natrii hydrogenocarbonas, **2**, 191; **5**, 276
 Natrii hydroxydum, **4**, 195
 Natrii nitris, **3**, 197; **5**, 290
 Natrii nitroprussidum, **3**, 199
 Natrii salicylas, **2**, 193; **3**, 383
 Natrii stibogluconas, **3**, 201; **4**, 316; **5**, 291
 Natrii sulfas, **3**, 203
 Natrii sulfas anhydricus, **3**, 205
 Natrii thiosulfas, **3**, 207; **5**, 291
 Natrii valproas, **3**, 209
 Neomycin sulfate, **3**, 211
 Neomycin B sulfate RS, *see* Framycetin sulfate RS
 Neomycini sulfas, **3**, 211
 Neostigmine bromide, **2**, 195
 Neostigmine metilsulfate, **3**, 214; **5**, 291
 Neostigmine metilsulfate RS, **3**, 357
 Neostigmini bromidum, **2**, 195
 Neostigmini metilsulfas, **3**, 213; **5**, 291
 Nephelometry and turbidimetry, **1**, 49
 Nessler's reagent, *see* Ammonium chloride TS
 Neutral red R, **3**, 357
 Neutral red/ethanol TS, **3**, 357
 Niclosamide, **2**, 196
 tablets, **4**, 246
 Niclosamide RS, **4**, 302
 Niclosamidi compressi, **4**, 246
 Niclosamidum, **2**, 196
 Nicotinamide, **2**, 198
 Nicotinamide RS, **2**, 306
 Nicotinamidum, **2**, 198
 Nicotinic acid, **2**, 26
 Nicotinic acid RS, **2**, 306
 Nifedipine, **5**, 119
 Nifedipine RS, **5**, 248
 Nifedipinum, **5**, 119
 Nifurtimox, **3**, 216
 Nifurtimox RS, **3**, 357
 Nifurtimoxum, **3**, 216
 Niridazole, **3**, 218
 Niridazole RS, **3**, 357
 Niridazole-chlorethylcarboxamide RS, **3**, 357
 Niridazolium, **3**, 218
 Nitrates, **1**, 114
 Nitrazepam, **3**, 220
 Nitrazepamum, **3**, 220
 Nitric acid (70 per cent), *see* Nitric acid (~1000 g/l) TS
 Nitric acid, fuming, R, **2**, 306; (~1000 g/l) TS, (~130 g/l) TS, (15 g/l) TS, (3 g/l) TS, **1**, 192; (1 mol/l) VS, **4**, 302; (0.05 mol/l) VS, **5**, 248
 Nitrite titration, **1**, 133
 4-Nitroaniline R, TS1, TS2, **2**, 306
 Nitrobenzene R, **1**, 192
 4-Nitrobenzoyl chloride R, **2**, 306
 Nitrofurantoin, **3**, 222
 tablets, **4**, 248
 Nitrofurantoin RS, **3**, 357
 Nitrofurantoini compressi, **4**, 248
 Nitrofurantoinum, **3**, 222
 Nitrogen, determination of, **1**, 136
 Nitrogen, oxygen-free, R, **2**, 306; R, **1**, 192
 Nitrogen-free sulfuric acid (~1760 g/l) TS, **1**, 209
 Nitrogen monoxide R, **5**, 248
 Nitrogen monoxide and nitrogen dioxide detector tube, **5**, 248
 Nitroglycerin tablets, *see* Glyceryl trinitrate tablets
 Nitromethane R, **3**, 357
 Nitrophenanthroline R, **4**, 303; **5**, 314; TS, **4**, 303
 1-Nitroso-2-naphthol-3,6-disodium disulfonate R, (2 g/l) TS **2**, 306
 1-Nitroso-2-naphthol-3,6-disodium sulfonate, *see* 1-Nitroso-2-naphthol-3,6-disodium disulfonate
 Nitrous oxide, *see* Dinitrogen oxide
 Nomenclature, monograph, **2**, 10; **4**, 1
 Non-aqueous titrations, **1**, 129
 Nonoxinol 9, **5**, 122
 Nonoxinol 9 RS, **5**, 248
 Nonoxinolum 9, **5**, 122
 Norethindrone enantate, *see* Norethisterone enantate
 Norethisterone, **2**, 202
 Norethisterone RS, **2**, 306
 Norethisterone acetate, **2**, 200
 Norethisterone acetate RS, **2**, 306
 Norethisterone enantate, **4**, 82; **5**, 301
 Norethisterone enantate RS, **4**, 303
 Norethisteroni acetas, **2**, 200
 Norethisteroni enantas, **4**, 82; **5**, 301
 Norethisteronum, **2**, 202
 Noroxymorphone hydrochloride RS, **3**, 358; **5**, 297
 Noscapine, **3**, 224
 Noscapine RS, **3**, 358
 Noscapine hydrochloride, **3**, 226
 Noscapini hydrochloridum, **3**, 226
 Noscapinum, **3**, 224
 Nystatin, **3**, 228; **4**, 317; **5**, 291

tablets, **4**, 249
 Nystatin RS, **3**, 358
 Nystatini compressi, **4**, 249
 Nystatinum, **3**, 228; **4**, 317; **5**, 291

O

iso-Octane, *see* 2,2,4-Trimethylpentane
 Octanoic acid R, **3**, 358
 Oil detector tube, **5**, 248
 Ointments, **4**, 44
 hydrophilic, **4**, 44
 hydrophobic, **4**, 44
 ophthalmic, **5**, 11
 water-emulsifying, **4**, 44
 Oleum arachidis, **4**, 197
 Olive oil R, **5**, 248
 Opalescence standard TS1, **2**, 306; TS2, **2**, 307; TS3, **4**, 303
 Opalescence stock standard TS, **2**, 307
 Ophthalmic preparations, **5**, 7
 drops, **5**, 9
 emulsions, **5**, 10
 ointments, **5**, 11
 suspensions, **5**, 10
 Optical rotation, determination of, **1**, 29
 Oracet blue B R, **3**, 358
 Oracet blue B/acetic acid TS, **3**, 358
 Oral Rehydration Salts, **4**, 219; **5**, 309
 ORS, *see* Oral Rehydration Salts
 Orthophosphates, **1**, 114
 Osmium tetroxide R, **2**, 307
 Other names, **4**, 2
 Oxalic acid R, (0.05 g/l) TS, **3**, 358
 Oxalic acid/sulfuric acid TS, **4**, 303
 Oxamniquine, **3**, 229
 Oxamniquine RS, **3**, 358
 Oxamniquinum, **3**, 229
 Ox brain, acetone-dried, R, **5**, 248
 Oxygen, **5**, 126
 Oxygen flask method, **1**, 123
 Oxygenium, **5**, 126
 Oxytetracycline dihydrate, **3**, 231; **5**, 291
 Oxytetracycline dihydrate RS, **3**, 358
 Oxytetracycline hydrochloride, **3**, 234; **5**, 292
 Oxytetracycline hydrochloride RS, **2**, 307
 Oxytetracyclini dihydras, **3**, 231; **5**, 291
 Oxytetracyclini hydrochloridum, **3**, 234; **5**, 292

P

Pancreatic digest of casein R, **1**, 192
 Papaic digest of soybean meal R, **1**, 192
 Papaverine hydrochloride, **2**, 204
 Papaverine hydrochloride RS, **2**, 307
 Papaverini hydrochloridum, **2**, 204

Paper chromatography, **1**, 84
 Paracetamol, **3**, 237
 tablets, **4**, 251; **5**, 312
 Paracetamol R, **4**, 303
 Paracetamol, 4-aminophenol-free, R, **3**, 358
 Paracetamoli compressi, **4**, 251; **5**, 312
 Paracetamolum, **3**, 237
 Paraffin, hard, **4**, 199
 liquid R, **1**, 192
 white soft, **4**, 198
 yellow soft, **4**, 198
 Paraffinum album, **4**, 198
 Paraffinum durum, **4**, 199
 Paraffinum flavum, **4**, 198
 Paraformaldehyde R, **3**, 358
 Paraldehyde R, **4**, 303
 Parenteral preparations, **4**, 36
 extractable volume for, **5**, 27
 injections, infusions, extractable volume for, **5**, 28
 specific types, **4**, 39
 Paromomycin sulfate, **3**, 239
 Paromomycin sulfate RS, **3**, 359
 Paromomycini sulfas, **3**, 239
 Particulate matter in injectable preparations, visual inspection of, **5**, 33
 Pastes, **4**, 44
 Patents, notice concerning, **1**, 12
 and trademarks, **4**, 6
 Peanut oil, *see* Arachis oil
 Penicillamine, **3**, 241
 Penicillaminum, **3**, 241
 Penicillin G benzathine, *see* Benzathine benzylpenicillin
 Penicillin G procaine, *see* Procaine benzylpenicillin
 Penicillinase R, **1**, 192; TS, **1**, 193
 Pentamidine isetionate, **3**, 243
 powder for injections, **4**, 282
 Pentamidine isetionate RS, **4**, 303
 Pentamidine mesilate, **3**, 245
 Pentamidini isetionas, **3**, 243
 Pentamidini isetionatis pulvis ad injectionem, **4**, 282
 Pentamidini mesilas, **3**, 245
n-Pentane R, **5**, 248
 1-Pentanesulfonic acid TS, **3**, 359
 1-Pentanesulfonic acid sodium salt R, **3**, 359
 Peptone, dried, R, R1, (5 g/l) TS, (1 g/l) TS1, (1 g/l) TS2, **1**, 194
 Perchloric acid (70 per cent w/w), *see* Perchloric acid (~1170 g/l) TS
 Perchloric acid (~1170 g/l) TS, (~140 g/l) TS, **1**, 194; TS, **5**, 249; (0.1 mol/l) VS, **1**, 194, **3**, 378; (0.05 mol/l) VS, **2**, 307; (0.02 mol/l) VS, **3**, 359
 Perchloric acid/dioxan (0.1 mol/l) VS, **3**, 359
 Periodic-acetic acid TS, **4**, 303
 Peroxides in fixed oils, determination of, **1**, 138
 Pethidine hydrochloride, **3**, 247; **5**, 292
 tablets, **5**, 172

- Pethidini hydrochloridi compressi, **5**, 172
 Pethidini hydrochloridum, **3**, 247; **5**, 292
 Petrolatum, *see* Paraffin
 Petroleum, light, **R**, **1**, 195; **R1**, **2**, 307
 pH, determination of, **1**, 95
 indicator paper **R**, **3**, 353
 pH values, precision of, **1**, 11
 Pharmaceutical preparations, microbial purity of, **5**, 28
 Phase solubility analysis, **1**, 102
o-Phenanthroline **R**, (1g/l) **TS**, **TS**, **1**, 195
 Phenobarbital, **2**, 206
 tablets, **5**, 174
 Phenobarbital **RS**, **5**, 249
 Phenobarbital sodium, **2**, 208, **3**, 383
 Phenobarbitali compressi, **5**, 174
 Phenobarbitalum, **2**, 206
 Phenobarbitalum natricum, **2**, 208, **3**, 383
 Phenol **R**, **1**, 195; (50g/l) **TS**, **4**, 304
 Phenol red **R**, **1**, 195
 Phenol red/ethanol **TS**, **1**, 195
 Phenoldisulfonic acid **TS**, (250g/l) **TS**, **4**, 304
 Phenolphthalein **R**, **1**, 195
 Phenolphthalein/ethanol **TS**, **1**, 195
 Phenolphthalein/pyridine **TS**, **1**, 195
 Phenoxyacetic acid **R**, **4**, 304
 2-Phenoxyethanol **R**, **2**, 307
 Phenoxyethylpenicillin, **2**, 210
 Phenoxyethylpenicillin **RS**, **2**, 307
 Phenoxyethylpenicillin calcium, **2**, 212
 Phenoxyethylpenicillin calcium **RS**, **2**, 308
 Phenoxyethylpenicillin potassium, **2**, 214
 tablets, **4**, 253
 Phenoxyethylpenicillin potassium **RS**, **2**, 308
 Phenoxyethylpenicillini kalici compressi, **4**, 253
 Phenoxyethylpenicillinum, **2**, 210
 Phenoxyethylpenicillinum calcicum, **2**, 212
 Phenoxyethylpenicillinum kalicum, **2**, 214
 1,4-Phenylenediamine dihydrochloride **R**, **3**, 359
 2-Phenylethanol **R**, **TS**, **2**, 308
 Phenylhydrargyri nitras, **4**, 200
 Phenylhydrazine **R**, **2**, 308
 Phenylhydrazine hydrochloride **R**, **2**, 308;
 (10g/l) **TS**, **3**, 360
 Phenylhydrazine/hydrochloric acid **TS**, **3**, 360
 Phenylhydrazine/sulfuric acid **TS**, **2**, 308
 Phenylmercuric nitrate, **4**, 200
 Phenyl/methylpolysiloxane **R**, **3**, 360
 Phenytoin, **2**, 216
 Phenytoin **RS**, **2**, 308
 Phenytoin sodium, **2**, 218; **5**, 276
 tablets, **5**, 176
 Phenytoini natrici compressi, **5**, 176
 Phenytoinum, **2**, 216
 Phenytoinum natricum, **2**, 218; **5**, 276
 Phloroglucinol **R**, **4**, 304
 Phosphate buffer, pH 4.0, **TS**, **4**, 304; pH 7.0,
 TS, **1**, 196; pH 7.0 (0.067 mol/l) **TS**, **4**,
 304; pH 7.2, **5**, 249; pH 7.4, **TS**, pH 7.6,
 TS, pH 8.0, **TS**, **3**, 360
 Phosphate buffer, sterile, pH 4.5, **TS**, **1**, 195;
 pH 6.0, **TS1**, **TS2**, **TS3**, **1**, 196; pH 7.0,
 TS, pH 7.2, **TS**, **1**, 196; pH 7.8, **TS**, **3**,
 360; pH 8.0, **TS1**, **TS2**, **1**, 197; pH 10.5,
 TS1, **3**, 360
 Phosphate/citrate buffer pH 4.5, **TS**, **2**, 308;
 pH 6.0, **TS**, **3**, 361
 Phosphate standard (5µg/ml) **TS**, **3**, 361
 Phosphate standard buffer, pH 6.8, **TS**, **1**, 97,
 196; pH 7.4, **TS**, **1**, 97, 197
 Phosphomolybdic acid **R**, **2**, 308; (80g/l) **TS**,
 4, 304
 Phosphomolybdic acid/ethanol **TS**, **4**, 304
 Phosphoric acid, *see* Phosphoric acid
 (~1440g/l) **TS**
 Phosphoric acid (~1440g/l) **TS**, **1**, 197;
 (~105g/l) **TS**, **3**, 361; (~20g/l) **TS**,
 (~2.8g/l) **TS**, **5**, 249
 Phosphorus, red, **R**, **2**, 308
 Phosphorus pentoxide **R**, **1**, 197
 Phosphotungstic acid **TS**, **3**, 361
 Phthalate buffer, pH 4.0, **TS**, **4**, 305
 Phthalic anhydride **R**, **1**, 197
 Phthalic anhydride/pyridine **TS**, **1**, 197
 Phyllochinonum, *see* Phytomenadionum
 Physostigmine salicylate, **2**, 220
 Physostigmini salicylas, **2**, 220
 Phytomenadione, **3**, 249; **5**, 293
 Phytomenadionum, **3**, 249; **5**, 293
 Phytanadione, *see* Phytomenadione
 Pilocarpine hydrochloride, **2**, 222; **4**, 314; **5**,
 276
 Pilocarpine nitrate, **2**, 224; **4**, 314; **5**, 277
 Pilocarpini hydrochloridum, **2**, 222; **4**, 314; **5**,
 276
 Pilocarpini nitras, **2**, 224; **4**, 314; **5**, 277
 Piperazine adipate, **2**, 226
 tablets, **4**, 255
 Piperazine adipate **RS**, **4**, 305
 Piperazine citrate, **2**, 228
 tablets, **4**, 256
 Piperazine citrate **RS**, **4**, 305
 Piperazine hydrate **R**, **4**, 305
 Piperazini adipas, **2**, 226
 Piperazini adipatis compressi, **4**, 255
 Piperazini citras, **2**, 228
 Piperazini citratis compressi, **4**, 256
 Piperidine **R**, **3**, 361
 Pix lithanthracis, **3**, 251
 Plasma substrate **R**, **5**, 249
 Platonic chloride **R**, (60g/l) **TS**, **2**, 308
 Podophylli resina, **4**, 84
 Podophyllinum, *see* Podophyllum resin
 Podophyllum resin, **4**, 84
 Polydimethylsiloxane **R**, **5**, 250
 Polyethylene glycol 400, *see* Macrogol 400
 Polysorbata 20, 60, 80, **4**, 202
 Polysorbate 80 **R**, **1**, 197
 Polysorbates 20, 60, 80, **4**, 202

- Polyvidone, **4**, 204; *see also* Povidone
 Polyvidonum, **4**, 204; *see also* Povidonum
 Polyvinylpyrrolidone, *see* Polyvidone
 Potassio-cupric tartrate TS, **2**, 309
 Potassio-mercuric iodide TS, alkaline TS, **2**, 309
 Potassium, **1**, 114
 Potassium acetate R, TS, **1**, 198
 Potassium antimonate R, TS, **3**, 361
 Potassium bicarbonate R, **1**, 198
 Potassium bitartrate, *see* Potassium hydrogen tartrate
 Potassium bromate R, (50 g/l) TS, **2**, 309; (0.0333 mol/l) VS, **4**, 305; (0.0167 mol/l) VS, **2**, 309; (0.00833 mol/l) VS, **3**, 361
 Potassium bromide R, IR, **1**, 198; (125 g/l) TS, **4**, 305; (100 g/l) TS, **1**, 198; (0.119 g/l) TS, **2**, 309
 Potassium carbonate R, **3**, 361
 anhydrous, R, **3**, 362
 Potassium chloride, **2**, 163; **3**, 382; **5**, 274
 Potassium chloride R, IR, (350 g/l) TS, **1**, 198; (100 g/l) TS, **3**, 362
 Potassium chromate R, (100 g/l) TS, **2**, 309
 Potassium citrate, **3**, 164
 Potassium cyanide R, **2**, 309; PbTS, **3**, 362; (100 g/l) TS, (50 g/l) TS, **2**, 309
 Potassium dichromate R, R1, TS, **1**, 198; TS2, TS3, **3**, 362; (100 g/l) TS, **2**, 309; (0.0167 mol/l) VS, **1**, 198
 Potassium dihydrogen phosphate R, **1**, 198; (100 g/l) TS, **3**, 362; (70 g/l) TS, **4**, 305; (27.2 g/l) TS, (13.6 g/l) TS, **3**, 362
 Potassium ferricyanide R, **1**, 198; (50 g/l) TS, **2**, 309; (10 g/l) TS, **1**, 199
 Potassium ferrocyanide R, (45 g/l) TS, **2**, 310
 Potassium hydrogen phthalate R, **1**, 199
 standard TS, **1**, 97, 199
 Potassium hydrogen sulfate R, **4**, 305
 Potassium hydrogen tartrate R, **1**, 199
 standard TS, **1**, 97, 199
 Potassium hydroxide R, **1**, 199; (~560 g/l) TS, **5**; (~400 g/l) TS, **4**, 305; (~100 g/l) TS, (1 mol/l) VS, **1**, 199; (0.5 mol/l) VS, (0.1 mol/l) VS, **1**, 200; (0.01 mol/l) VS, **2**, 310
 Potassium hydroxide/ethanol TS1, **1**, 199; TS2, **2**, 310; (1 mol/l) VS, **2**, 310; (0.5 mol/l) VS, **1**, 200; (0.1 mol/l) VS, **5**, 250; (0.02 mol/l) VS, **1**, 200
 Potassium hydroxide/methanol TS, **2**, 310
 Potassium iodate R, **2**, 310; (3.6 mg/l) TS, **3**, 362; (0.05 mol/l) VS, (0.01 mol/l) VS, **2**, 310
 Potassium iodide, **2**, 165; **3**, 382
 Potassium iodide R, AsR, **1**, 200; (400 g/l) TS, (300 g/l) TS, **2**, 310; (160 g/l) TS, **5**, 250; (100 g/l) TS, **3**, 362; (80 g/l) TS, **1**, 200; (60 g/l) TS, **2**, 311
 Potassium iodide/starch TS1, **2**, 311
 Potassium iodobismuthate TS1, TS2, **2**, 311
 Potassium iodobismuthate/acetic acid TS, **5**, 250
 Potassium iodoplatinate TS, **2**, 311; TS2, **3**, 362
 Potassium nitrate R, **1**, 200
 Potassium nitrite R, (100 g/l) TS, **1**, 200
 Potassium periodate R, TS, **2**, 311
 Potassium permanganate R, **1**, 201; (25 g/l) TS, **3**, 363; (10 g/l) TS, **1**, 201; (1 g/l) TS, **5**, 250; (0.02 mol/l) VS, **1**, 201; (0.002 mol/l) VS, **2**, 311; (0.0002 mol/l) VS, **4**, 305
 Potassium permanganate/phosphoric acid TS, **4**, 305
 Potassium sodium tartrate R, **2**, 311
 Potassium sulfate R, **1**, 201; (0.1 g/l) TS, **4**, 305; (174 mg/l) TS, **1**, 201
 Potassium tetraoxalate R, **1**, 201
 standard TS, **1**, 97, 201
 Potassium thiocyanate R, **2**, 311, **3**, 386; (200 g/l) TS, **3**, 363
 Potato starch, *see* Starches
 Povidone, 308, **5**; *see also* Polyvidone
 Povidonum, 308, **5**; *see also* Polyvidonum
 Powder fineness and sieves, **1**, 74
 Powders for injections, **4**, 40, 273
 PPO, *see* 2,5-Diphenyloxazole
 Praziquantel, **3**, 252; **5**, 293
 tablets, **5**, 177
 Praziquantel RS, **3**, 363
 Praziquanteli compressi, **5**, 177
 Praziquantelum, **3**, 252; **5**, 293
 Precision, expression of concentration, **4**, 6
 pH values, **1**, 11; **4**, 6
 quantities, **1**, 10; **4**, 6
 temperature measurements, **1**, 11; **4**, 6
 volumes, **4**, 6
 Prednisolone, **2**, 230
 tablets, **5**, 179
 Prednisolone RS, **2**, 312
 Prednisolone acetate, **3**, 254
 Prednisolone acetate RS, **3**, 363
 Prednisolone sodium phosphate, **5**, 132
 injection, **4**, 269; **5**, 312
 Prednisolone sodium phosphate RS, **3**, 363
 Prednisolone sodium succinate powder for injections, **4**, 284; **5**, 312
 Prednisolone succinate RS, **4**, 305
 Prednisoloni acetas, **3**, 254
 Prednisoloni compressi, **5**, 179
 Prednisoloni natrii phosphas, **5**, 132
 Prednisoloni et natrii phosphatis injectio, **4**, 269; **5**, 312
 Prednisoloni et natrii succinatis pulvis ad injectionem, **4**, 284; **5**, 312
 Prednisolonum, **2**, 230
 Preface, **1**, 7; **2**, 7; **3**, 8; **4**, ix; **5**, vii
 Preparations, ophthalmic, **5**, 7
 Primaquine diphosphate, **2**, 232
 tablets, **4**, 258
 Primaquine diphosphate RS, **2**, 312

- Primaquini diphosphas, **2**, 232
 Primaquini diphosphatis compressi, **4**, 258
 Probenecid, **3**, 256
 tablets, **4**, 260
 Probenecid RS, **3**, 363
 Probenecidi compressi, **4**, 260
 Probenecidum, **3**, 256
 Procainamide hydrochloride, **2**, 234; **5**, 277
 Procainamidi hydrochloridum, **2**, 234; **5**, 277
 Procaine benzylpenicillin, **3**, 258; **5**, 293
 powder for injections, **4**, 287; **5**, 312
 Procaine hydrochloride, **2**, 236
 Procaine hydrochloride RS, **2**, 312
 Procaine penicillin, *see* Procaine benzylpenicillin
 Procaini benzylpenicillini pulvis ad injectionem, **4**, 287; **5**, 312
 Procaini benzylpenicillinum, **3**, 258; **5**, 293
 Procaini hydrochloridum, **2**, 236
 Procarbazine hydrochloride, **3**, 260
 Procarbazine hydrochloride RS, **3**, 363
 Procarbazine hydrochloridum, **3**, 260
 Procedure for the selection of recommended International Nonproprietary Names (INN) for pharmaceutical substances, **5**, 317
 Progesterone, **2**, 238
 Progesterone RS, **2**, 312
 Progesteronum, **2**, 238
 Proguanil hydrochloride, **5**, 231
 Proguanil hydrochloride RS, **5**, 250
 Proguanili hydrochloridum, **5**, 231
 Promethazine hydrochloride, **3**, 262; **5**, 294
 Promethazini hydrochloridum, **3**, 262; **5**, 294
 1-Propanol R, **2**, 312
 2-Propanol, **4**, 206
 2-Propanol R, **2**, 312
 2-Propanolum, **4**, 206
 Propranolol hydrochloride, **2**, 240; **3**, 383
 Propranolol hydrochloride RS, **2**, 312
 Propranololi hydrochloridum, **2**, 240; **3**, 383
 Propylene glycol, **4**, 207
 Propylene glycol R, **2**, 312
 Propyleneglyolum, **4**, 207
 Propyl hydroxybenzoate, **4**, 209
 Propyliodone, **4**, 86; **5**, 301
 Propyliodonum, **4**, 86; **5**, 301
 Propylis hydroxybenzoas, **4**, 209
 Propylparaben, *see* Propyl hydroxybenzoate
 Propylthiouracil, **2**, 242
 Propylthiouracilum, **2**, 242
 Protamine sulfate, **5**, 135
 Protamini sulfas, **5**, 135
 Protionamide, **3**, 264
 Protionamide RS, **3**, 363
 Protionamidum, **3**, 264
 Provitamini D₂, *see* Ergosterol
 Purified water, **4**, 131; **5**, 306
 Pyranel embonate, **3**, 265
 tablets, **5**, 181
 Pyranel embonate RS, **3**, 363
 Pyranel pamoate, *see* Pyranel embonate
 Pyranteli embonas, **3**, 265
 Pyranteli embonatis compressi, **5**, 181
 Pyrazinamide, **3**, 268
 tablets, **4**, 261
 Pyrazinamide RS, **3**, 363
 Pyrazinamidi compressi, **4**, 261
 Pyrazinamidum, **3**, 268
 Pyridine, anhydrous R, R, **1**, 201
 Pyridine/acetic anhydride TS, **4**, 305
 Pyridostigmine bromide, **2**, 244; **3**, 383; **5**, 277
 Pyridostigmine bromide RS, **2**, 312
 Pyridostigmini bromidum, **2**, 244; **3**, 383; **5**, 277
 Pyridoxine hydrochloride, **2**, 246; **4**, 314
 Pyridoxini hydrochloridum, **2**, 246; **4**, 314
 Pyrimethamine, **3**, 269
 Pyrimethamine RS, **3**, 363
 Pyrimethaminum, **3**, 269
 Pyrogallol R, alkaline, TS, **2**, 313
 Pyrogens, test for, **1**, 155
- ## Q
- Quantities and their precision, **1**, 10
 Quinaldine red R, **2**, 313
 Quinaldine red/ethanol TS, **2**, 313
 Quinaldine red/methanol TS, **2**, 313
 Quinhydrone R, **4**, 306
 Quinhydrone/methanol TS, **4**, 306
 Quinidine sulfate, **3**, 271
 Quinidini sulfas, **3**, 271
 Quinine R, **2**, 313
 Quinine bisulfate, **3**, 273
 Quinine dihydrochloride, **3**, 276; **5**, 294
 injection, **4**, 271
 Quinine hydrochloride, **2**, 248; **3**, 384
 Quinine sulfate, **2**, 250; **3**, 384
 Quinini bisulfas, **3**, 273
 Quinini dihydrochloridi injectio, **4**, 271
 Quinini dihydrochloridum, **3**, 276; **5**, 294
 Quinini hydrochloridum, **2**, 248; **3**, 384
 Quinini sulfas, **2**, 250; **3**, 384
- ## R
- Radiopharmaceuticals, **1**, 52
 Reagents, **1**, 13
 test solutions and volumetric solutions, list of, **1**, 167; **2**, 277; **3**, 337; **4**, 293; **5**, 235, 280, 296, 314
 Red stock standard RS, **1**, 201; **3**, 378
 Reference spectra, **4**, **8**; **5**, 326
 Reference substances, **4**, **7**
 biological, **4**, **7**
 chemical, **4**, **8**

Refractive index, determination of, **1**, 32
Rehydration salts, oral **4**, 219; **5**, 309
Relative atomic masses, names, and symbols, of elements, **1**, 167
Relative density and mass density, determination of, **1**, 27
Relative molecular mass, **4**, 1
Resazurin sodium R, (1 g/l) TS, **1**, 201
Reserpine, **2**, 252; **3**, 384; **5**, 277
Reserpine RS, **2**, 313
Reserpinum, **2**, 252; **3**, 384; **5**, 277
Resorcinol R, (20 g/l) TS, **1**, 201
Resorcinol/toluene TS, **4**, 306
Results, calculation of, **1**, 11; **4**, 6
Retinol acetate RS, **5**, 250
Retinol concentrate, oily form, **5**, 138
Retinol palmitate RS, **5**, 250
Retinol propionate RS, **5**, 250
Retinolum densatum oleosum, **5**, 138
Riboflavin, **2**, 254; **5**, 278
Riboflavin RS, **2**, 313
Riboflavinum, **2**, 254; **5**, 278
1-β-D-Ribofuranosyluracil, *see* Uridine
Rice starch, *see* Starches
Rifampicin, **3**, 278
Rifampicin RS, **3**, 363
Rifampicin quinone RS, **3**, 363
Rifampicinum, **3**, 278
Rotation, optical, specific, determination of, **1**, 29

S

Saccharin sodium, **4**, 211; **5**, 309
Saccharimidum natricum, *see* Saccharin sodium
Saccharinum natricum, **4**, 211; **5**, 309
Salazosulapyridine, *see* Sulfasalazine
Salbutamol, **3**, 280
Salbutamol RS, **3**, 363
Salbutamol sulfate, **3**, 282; **5**, 294
Salbutamol sulfate RS, **3**, 363
Salbutamoli sulfas, **3**, 282; **5**, 294
Salbutamololum, **3**, 280
Sales perorales ad rehydrationem, **4**, 219; **5**, 309
Salicylaldehyde R, TS, **3**, 363
Salicylates, **1**, 114
Salicylic acid, **2**, 28
Salicylic acid R, **2**, 313
Saline TS, **1**, 202
Saponification value, determination of, **1**, 139
Selenii disulfidum, **5**, 140
Selenious acid R, **2**, 313; **4**, 315
Selenious acid/sulfuric acid TS, **2**, 314
Selenium R, **1**, 202
Selenium disulfide, **5**, 140
Semi-solid dosage forms, topical, **4**, 42

Sennae folium, **3**, 284
Sennae fructus, **3**, 286
Senna fruit, **3**, 286
Senna leaf, **3**, 284
Sieves and powder fineness, **1**, 74
Silica gel, desiccant, R, **1**, 202; R1, R2, R3, R4, R5, **2**, 314; R6, **3**, 363
for chromatography R, **5**, 251
Silver nitrate, **3**, 28
Silver nitrate R, **1**, 202; (100 g/l) TS, **3**, 364; (40 g/l) TS, (0.1 mol/l) VS, **1**, 202; (0.05 mol/l) VS, **4**, 306; (0.01 mol/l) VS, **3**, 364; (0.001 mol/l) VS, **4**, 306
Silver nitrate/methanol TS, **3**, 364
Silver oxide R, **2**, 314
Silver standard (5 µg Ag/ml) TS, **4**, 306
Silver sulfadiazine, *see* Sulfadiazine silver
Simulated gastric intestinal fluid TS, **5**, 243
Simulated intestinal fluid TS, **5**, 243
Soda lime R, **1**, 202
Sodium, **1**, 115
Sodium R, **2**, 315
Sodium acetate (150 g/l) TS, **1**, 202; R, (60 g/l) TS, (50 g/l) TS, **2**, 315; (0.04 mol/l) VS, **4**, 306
Sodium acetate/glacial acetic acid (0.1 mol/l) VS, **3**, 364
Sodium alizarinsulfonate R, **1**, 203; (10 g/l) TS, **3**, 364; (1 g/l) TS, **1**, 203
Sodium amidotrizoate, **4**, 79
Sodium amidotrizoate RS, **4**, 306
Sodium antimonyltartrate, *see* Antimony sodium tartrate
Sodium arsenite (0.1 mol/l) VS, **2**, 316; (0.05 mol/l) VS, **2**, 316, **3**, 386
Sodium bicarbonate, *see* Sodium hydrogen carbonate
Sodium bicarbonate R, **1**, 203; **2**, 317
Sodium biphosphate, *see* Sodium dihydrogen phosphate
Sodium calcium edetate, **3**, 190; **5**, 290
Sodium carbonate, anhydrous, FeR, **2**, 316; anhydrous, R, R, **1**, 203; (200 g/l) TS, (75 g/l) TS, **2**, 316; (50 g/l) TS, **1**, 203; (10 g/l) TS, **2**, 316; standard TS, **1**, 97, 203; **4**, 313
Sodium chloride, **2**, 189; **5**, 276
Sodium chloride R, **1**, 203; pyrogen-free R, **2**, 316; (400 g/l) TS, **3**, 364; (300 g/l) TS, **5**, 251; (10 g/l) TS, **3**, 364; (9 g/l) TS, **5**, 251
Sodium citrate, **3**, 192
Sodium citrate R, **1**, 203; (250 g/l) TS, **4**, 306
Sodium cobaltinitrite R, (100 g/l) TS, **1**, 203
Sodium cromoglicate, **3**, 194
Sodium cromoglicate RS, **3**, 364
Sodium diatrizoate, *see* Sodium amidotrizoate
Sodium diethyldithiocarbamate R, (0.8 g/l) TS, **2**, 316
Sodium dihydrogen phosphate R, **2**, 317; (275 g/l) TS, **3**, 364; (45 g/l) TS, **2**, 317

- Sodium dithionate R, (200 g/l) TS, **5**, 251
 Sodium fluoride, **3**, 196
 Sodium fluoride R, **1**, 203
 Sodium formate R, **3**, 364
 Sodium hexanesulfonate R, **5**, 251
 Sodium hydrogen carbonate, **2**, 191; **5**, 276
 Sodium hydrogen carbonate R, **2**, 317;
 (100 g/l) TS, **4**, 306; (40 g/l) TS, **2**, 317
 Sodium hydroxide, **4**, 195
 Sodium hydroxide R (~400 g/l) TS, **1**, 203;
 (~300 g/l) TS, (~200 g/l) TS, **1**, 204;
 (~150 g/l) TS, **2**, 317; (~80 g/l) TS, **1**, 204;
 (50 g/l) TS, **3**, 365; (10 g/l) TS, **2**, 317;
 (1 mol/l) VS, **1**, 204; (0.5 mol/l) VS, **2**,
 317; (0.2 mol/l) VS, (0.1 mol/l) VS, (0.05
 mol/l) VS, **1**, 204; (0.02 mol/l) VS, **2**, 317;
 (0.01 mol/l) VS, **1**, 204; (0.001 mol/l) VS,
2, 317
 Sodium hydroxide (0.1 mol/l) LAL, **5**, 251
 Sodium hydroxide (1 mol/l), carbonate-free,
 VS, (0.5 mol/l), carbonate-free, VS,
 (0.2 mol/l), carbonate-free, VS, (0.1 mol/l),
 carbonate-free, VS, **1**, 205; (0.02 mol/l),
 carbonate-free, VS, (0.01 mol/l),
 carbonate-free, VS, **1**, 206
 Sodium hydroxide/ethanol TS, **3**, 365
 Sodium hydroxide/methanol TS, **2**, 317
 Sodium hypobromite TS, **5**, 251
 Sodium hypochlorite, TS1, **2**, 318; (~40 g/l)
 TS, **2**, 317
 Sodium laurilsulfate R, **4**, 306; (10 g/l) TS, **4**,
 307
 Sodium mercaptoacetate R, **1**, 206
 Sodium metabisulfite R, **2**, 318; (50 g/l) TS, **4**,
 307
 Sodium metaperiodate R, **2**, 318; TS, **4**, 307
 Sodium methoxide (0.1 mol/l) VS, **2**, 318
 Sodium molybdotungstophosphate TS, **2**, 318
 Sodium 1,2-naphthoquinone-4-sulfonate R,
 (5 g/l) TS, **2**, 318
 Sodium nitrate R, **5**, 251
 Sodium nitrite, **3**, 197; **5**, 290
 Sodium nitrite R, **1**, 206; (100 g/l) TS, **2**, 319;
 (50 g/l) TS, **4**, 307; (35 g/l) TS, **3**, 365;
 (20 g/l) TS, **4**, 307; (10 g/l) TS, **1**, 206;
 (3 g/l) TS, (1 g/l) TS, **2**, 319; (0.1 mol/l)
 VS, **1**, 206
 Sodium nitrite/hydrochloric acid TS, **4**, 307
 Sodium nitroferricyanide, *see* Sodium
 nitroprusside
 Sodium nitroprussiate, *see* Sodium
 nitroprusside
 Sodium nitroprusside, **3**, 199
 Sodium nitroprusside R, **2**, 319; alkaline, TS,
3, 365; (45 g/l) TS, **2**, 319; (8.5 g/l) TS, **3**,
 365
 Sodium octanesulfonate R, **5**, 251
 Sodium oxalate R, **1**, 206
 Sodium peroxide R, **3**, 365
 Sodium phosphate, *see* Disodium hydrogen
 phosphate
 Sodium phosphate, anhydrous, *see* Disodium
 hydrogen phosphate, anhydrous
 Sodium potassium tartrate, *see* Potassium
 sodium tartrate
 Sodium salicylate, **2**, 193; **3**, 388
 Sodium salicylate R, (11.5 g/l) TS, **3**, 365
 Sodium standard (200 µg Na/ml) TS, **5**, 251
 Sodium stibogluconate, **3**, 201; **4**, 316; **5**, 291
 Sodium sulfate, **3**, 203
 Sodium sulfate, anhydrous, **3**, 205
 Sodium sulfate, anhydrous, R, **1**, 206
 Sodium sulfide, R, TS, **1**, 206
 Sodium sulfite, R, **3**, 365
 Sodium tetraborate R, **1**, 206; (10 g/l) TS, **2**,
 319
 standard, TS, **1**, 97, 207
 Sodium tetrabromofluorescein, *see* Eosin Y
 Sodium tetraphenylborate R, (30 g/l) TS, **1**, 207
 Sodium thioglycolate, *see* Sodium
 mercaptoacetate
 Sodium thiosulfate, **3**, 207; **5**, 291
 Sodium thiosulfate R, **1**, 208; (320 g/l) TS, **2**,
 319; (0.1 mol/l) VS, **1**, 207, **2**, 319;
 (0.05 mol/l) VS, **1**, 208; (0.02 mol/l) VS, **2**,
 319; (0.01 mol/l) VS, **1**, 208; (0.002 mol/l)
 VS, **5**, 252
 Sodium tungstate R, **2**, 319
 Sodium valproate, **3**, 209
 Soft capsules, **4**, 34
 Solid oral dosage forms, dissolution test, **5**,
 18
 Solochrome Black, *see* Mordant Black 11
 Solochrome Dark Blue, *see* Calcon
 Solubility, **1**, 11; **4**, 2
 Soluble starch R, **1**, 208
 Soluble tablets, **4**, 29
 Solutions, **1**, 11, 13
 Solutions, list of, *see* Test solutions
 Solvent blue 19, *see* Oracet blue B
 Sorbitol R, **2**, 319
 Specific rotation, determination of, **1**, 29
 Spectinomycin hydrochloride, **3**, 288; **5**,
 295
 Spectinomycin hydrochloride RS, **3**, 365
 Spectinomycini hydrochloridum, **3**, 288; **5**,
 295
 Spectrophotometry, atomic absorption, **1**, 43
 fluorescence, **1**, 45
 in the infrared region, **1**, 40
 in the visible and ultraviolet regions, **1**, 33
 Spermaceti, synthetic, *see* Cetyl esters wax
 Spironolactone, **3**, 290
 Spironolactone RS, **3**, 365
 Spironolactonium, **3**, 290
 Squalane R, **3**, 365
 Stability information, **2**, 12; **4**, 3
 Standard buffer solutions, **1**, 97, 98
 Standard colour solutions, **1**, 51
 Stannated hydrochloric acid (~250 g/l) AsTS,
1, 184
 Stannous chloride R, AsTS, TS, **1**, 208

- Stannous chloride/hydrochloric acid TS1, **4**, 307
- Starch, soluble, R, **1**, 208
- Starch R, TS, **1**, 208
- Starch iodide TS, **2**, 320
- Starch/iodide paper R, **1**, 208
- Starches, **4**, 129
- Stationary phases for High-Performance Liquid Chromatography, A, B, C, D, **5**, 252, 258
- Steam sterilization, **4**, 19
- Sterile phosphate buffer, pH 4.5, TS, **1**, 195; pH 6.0, TS1, TS2, TS3, **1**, 196; pH 7.0, TS, pH 7.2, TS, **1**, 196; pH 7.8, TS, **3**, 360; pH 8.0, TS1, TS2, **1**, 197; pH 10.5, TS1, **3**, 360
- Sterile water for injections, **4**, 134
- Sterility, test for, **4**, 15, **5**, 32
testing for antibiotics, **1**, 151
- Sterilization, methods of, **4**, 18
dry-heat, **4**, 20
filtration, **4**, 21
gas, **4**, 22
ionizing radiation, **4**, 21
steam, **4**, 19
- Stibii natrii tartras, **3**, 393
- Stock colour standard solutions, **1**, 51
- Storage, **4**, 2
containers, **4**, 2
protection from light, **4**, 3
temperature, **4**, 3; **5**, 9, 14
- Streptomycin sulfate, **2**, 256; **5**, 278
powder for injections, **4**, 289; **5**, 313
- Streptomycin sulfate RS, **4**, 307
- Streptomycini sulfas, **2**, 256; **5**, 278
- Streptomycini sulfatis pulvis ad injectionem, **4**, 289; **5**, 313
- Strong arsenic AsTS, **1**, 170
- Strong cobalt colour TS, **1**, 174
- Strong copper colour TS, **1**, 175
- Strong dichromate colour RS, **1**, 177
- Strong histamine TS, **1**, 182
- Strong iron colour TS, **1**, 186
- Strong lead PbTS, **1**, 187
- Strychnine sulfate R, **2**, 320
- Sublingual tablets, **4**, 30
- Succamethonium chloratum, *see*
Suxamethonii chloridum
- Succinylcholine chloride, *see* Suxamethonium chloride
- Sudan red G R, **3**, 365; TS, **3**, 366
- Sugar-coated tablets, **4**, 30
- Sulfacetamide, **3**, 294
- Sulfacetamide RS, **3**, 366
- Sulfacetamide sodium, **3**, 296
- Sulfacetamidum, **3**, 294
- Sulfacetamidum natricum, **3**, 296
- Sulfacylum-natricum, *see* Sulfacetamide sodium
- Sulfadiazine RS, **5**, 252
- Sulfadiazine silver, **5**, 142
- Sulfadiazinum argentum, **5**, 142
- Sulfadimezinum, *see* Sulfadimidinum
- Sulfadimidine, **3**, 298
- Sulfadimidine RS, **3**, 366
- Sulfadimidine sodium, **3**, 300
- Sulfadimidinum, **3**, 298
- Sulfadimidinum natricum, **3**, 300
- Sulfadoxine, **3**, 302
- Sulfadoxine RS, **3**, 366
- Sulfadoxinum, **3**, 302
- Sulfamethazine, *see* Sulfadimidine
- Sulfamethoxazole, **2**, 259; **5**, 279
- Sulfamethoxazole RS, **2**, 320
- Sulfamethoxazololum, **2**, 259; **5**, 279
- Sulfamethoxy-pyridazine, **2**, 261
- Sulfamethoxy-pyridazine RS, **2**, 320
- Sulfamethoxy-pyridazinum, **2**, 261
- Sulfamic acid R, **2**, 320; (80 g/l) TS, **4**, 307; (50 g/l) TS, **2**, 320; (5 g/l) TS, **3**, 366
- 4-Sulfamoylbenzoic acid, R, **4**, 307
- Sulfanilamide RS, **2**, 320
- Sulfanilic acid, R, **2**, 320
diazotized, TS, **3**, 366
- Sulfasalazine, **3**, 305
- Sulfasalazine RS, **3**, 366
- Sulfasalazinum, **3**, 305
- Sulfated ash, **1**, 123
- Sulfate-free ethanol (~750 g/l) TS, **1**, 180
- Sulfates, **1**, 115
limit test for, **1**, 116
- Sulfosalicylic acid R, **1**, 208; (175 g/l) TS, **1**, 209
- Sulfur, determination of, **1**, 125
- Sulfur dioxide R, **1**, 209
- Sulfuric acid, *see* Sulfuric acid (~1760 g/l) TS
- Sulfuric acid, nitrogen-free, TS, (~1760 g/l) TS, **1**, 209; (~1125 g/l) TS, **4**, 308; (~700 g/l) TS, (~635 g/l) TS, (~570 g/l) TS, **2**, 320; (~440 g/l) TS, **4**, 308; (~190 g/l) TS, (~100 g/l) TS, **1**, 209; (~50 g/l) TS, **2**, 320; (~10 g/l) TS, (0.5 mol/l) VS, **1**, 209; (0.25 mol/l) VS, **2**, 321; (0.125 mol/l) VS, **3**, 366; (0.1 mol/l) VS, **2**, 321; (0.05 mol/l) VS, (0.01 mol/l) VS, **1**, 209; (0.005 mol/l) VS, **1**, 210
- Sulfuric acid/ethanol TS, **2**, 321
- Sulfuric acid/methanol TS, **3**, 366
- Sulfurous acid TS, **2**, 321
- Supports for high-performance liquid chromatography, stationary phases A, B, C, D, **5**, 252
- Suppositories, **5**, 11
disintegration test for, **5**, 13, 14
- Suramin sodium, **3**, 307; **5**, 295
- Suraminum natricum, **3**, 307; **5**, 295
- Suspensions, ophthalmic, **5**, 10
- Suxamethonii chloridum, **3**, 310; **5**, 295
- Suxamethonium chloride, **3**, 310; **5**, 295
- Symbols, and abbreviations, **4**, 9

names, and relative atomic masses of elements, **1**, 167
 Synonyms, **4**, 2
 Synthetic spermaceti, *see* Cetyl esters wax

T

- Tablets, **4**, 26, 226; **5**, 147
 buccal, **4**, 30
 chewable, **4**, 30
 coated, **4**, 30
 delayed-release, **4**, 31
 effervescent, **4**, 29
 enteric-coated, **4**, 31
 extended-release, **4**, 31
 film-coated, **4**, 31
 for use in the mouth, **4**, 30
 modified-release, **4**, 31
 soluble, **4**, 29
 specific types, **4**, 29
 sublingual, **4**, 30
 sugar-coated, **4**, 30
 uncoated, **4**, 29
 Tablets and capsules, disintegration test for, **4**, 40
 Talc, **4**, 213
 Talcum, **4**, 213
 Tamoxifen citrate, **4**, 88; **5**, 302
 Tamoxifen citrate RS, **4**, 308
 Tamoxifen citrate *E*-isomer RS, **5**, 252, 314
 Tamoxifen citrate impurity standard RS, **4**, 308, **5**, 314
 Tamoxifeni citras, **4**, 88; **5**, 302
 Tannic acid R, (50 g/l) TS, **3**, 366
 Tartaric acid R, **2**, 321; (200 g/l) TS, **3**, 366; (10 g/l) TS, (5 g/l) TS, **2**, 321
 Tartrates, **1**, 115
 Temperature, measurements and their precision, **1**, 11
 storage, **4**, 3
p-Terphenyl R, **1**, 210
 Test for bacterial endotoxins, **5**, 30
 disintegration test for suppositories, **5**, 13, 14
 dissolution test for solid oral dose forms, **5**, 18
 extractable volume for parareteral preparations, **5**, 27
 particulate matter in injectable preparations, **5**, 33
 sterility of non-injectable preparations, **5**, 32
 Test solutions, reagents, and volumetric solutions, list of, **1**, 167; **2**, 277; **3**, 337; **4**, 293; **5**, 235, 280, 296, 314
 Testosterone enantate, **3**, 312; **5**, 295
 Testosterone enantate RS, **3**, 366
 Testosterone propionate, **2**, 263; **3**, 385
 Testosterone propionate R, **4**, 308; RS, **2**, 321
 Testosterone propionate/ethanol TS, **4**, 308
 Testosteroni enantas, **3**, 312; **5**, 295
 Testosteroni propionas, **2**, 263; **3**, 385
 Tests, and assays, **4**, 5
 for dosage forms, **5**, 14
 identity, **4**, 4
 methods and general requirements, **4**, 13; **5**, 297, 298
 Tetrabromophenolphthalein ethyl ester R, TS, **4**, 308
 Tetrabutylammonium hydrogen sulfate R, **5**, 252
 Tetrabutylammonium hydroxide TS, **3**, 367; (0.1 mol/l) VS, **2**, 321
 Tetrabutylammonium hydroxide/methanol TS, **3**, 366
 Tetrabutylammonium iodide R, **2**, 322
 Tetracaine hydrochloride, **3**, 314; **5**, 296
 Tetracaini hydrochloridum, **3**, 314; **5**, 296
 Tetrachloroethane R, **2**, 322
 Tetracycline hydrochloride, **2**, 266; **5**, 279
 Tetracycline hydrochloride RS, **2**, 322
 Tetracyclini hydrochloridum, **2**, 266; **5**, 279
n-Tetradecane R, **2**, 322
 Tetrahydrofuran R, **3**, 367
 Tetramethylammonium hydroxide (~100 g/l) TS, **2**, 322
 Tetramethylammonium hydroxide/ethanol TS, **2**, 323
 Thiamine hydrobromide, **3**, 316
 Thiamine hydrochloride, **3**, 318
 Thiamine mononitrate, **3**, 319
 Thiamini hydrobromidum, **3**, 316
 Thiamini hydrochloridum, **3**, 318
 Thiamini mononitras, **3**, 319
 Thin-layer chromatography, **1**, 80
 Thioacetamide R, **4**, 308; alkaline, TS, **4**, 308
 Thioacetazone, **3**, 321
 Thioacetazone RS, **3**, 367
 Thioacetazonum, **3**, 321
 4,4'-Thiodianiline RS, **2**, 323
 Thioglycolic acid, *see* Mercaptoacetic acid
 Thiopental RS, **4**, 308; **5**, 252, 314
 Thiopental sodium, **4**, 90, **5**, 302
 Thiopental sodium RS, *see* Thiopental RS
 Thiopentalum natriicum, **4**, 90; **5**, 302
 Thiourea R, (0.1 g/l) TS, **2**, 323
 Thorin R, (2 g/l) TS, **1**, 210
 Thorium nitrate R, (0.005 mol/l) VS, **1**, 210
 Thymol R, TS1, TS2, TS3, **2**, 323
 Thymol blue R, **2**, 323
 Thymol blue/dimethylformamide RS, **2**, 324
 Thymol blue/ethanol TS, **2**, 324
 Thymol blue/methanol TS, **2**, 324
 Thymolphthalein R, **1**, 210
 Thymolphthalein/dimethylformamide TS, **2**, 324
 Thymolphthalein/ethanol TS, **1**, 210
 Thyroxine sodium, *see* Levothyroxine sodium
 Tiabendazole, **3**, 323

Tiabendazole RS, **3**, 367
Tiabendazolium, **3**, 323
Tightly closed containers, definition of, **1**, 12;
4, 3
Timolol maleate, **4**, 93; **5**, 303
Timolol maleate RS, **4**, 308
Timololi maleas, **4**, 93; **5**, 303
Titan yellow R, TS, **3**, 367
Titanium dioxide R, **2**, 324
Titanium dioxide/sulfuric acid TS, **2**, 324
Titanium trichloride R, (0.1 mol/l) VS, **3**, 367
Titration, complexometric, **1**, 126
 nitrite, **1**, 133
 non-aqueous, **1**, 129
Tolbutamide, **2**, 270
Tolbutamide RS, **2**, 324
Tolbutamidum, **2**, 270
Toluene R, **1**, 210
4-Toluenesulfonamide R, **2**, 324
Toluene-2-sulfonamide RS, **4**, 308
4-Toluenesulfonic acid R, **2**, 324
4-Toluenesulfonic acid/ethanol TS, **2**, 324
Topical semi-solid dosage forms, **4**, 42
Tosylchloramide sodium R, **2**, 325; **3**, 386;
(15 g/l) TS, **2**, 325
Toxicity, undue, **1**, 154
Trademarks, and patents, **4**, 6
 trade names, notices concerning, **1**, 12, 13
Tribasic calcium phosphate, *see* Calcium
 phosphate
Tributyl phosphate R, **4**, 309
Trichloroacetic acid R, **2**, 325
Trichloroethylene R, **2**, 325
Trichlorotrifluoroethane R, TS, **2**, 325
Triethylamine R, **4**, 309
Triethylenediamine R, **4**, 309
Trihexyphenidyl hydrochloride, **3**, 325
Trihexyphenidyl hydrochloride RS, **3**, 367
Trihexyphenidyl hydrochloridum, **3**, 325
Triketohydrindene/butanol TS, **3**, 367
Triketohydrindene/butanol/acetic acid TS, **5**,
252
Triketohydrindene/cadmium TS, **2**, 325
Triketohydrindene/ethanol TS, **4**, 309
Triketohydrindene hydrate R, **2**, 325; (1 g/l)
TS, **3**, 368
Triketohydrindene/methanol TS, **3**, 368
Triketohydrindene/pyridine/acetone TS, **3**,
368
Triketohydrindene/pyridine/butanol TS, **3**,
368
Triketohydrindene/sodium metabisulfite TS,
4, 309
Triketohydrindene/stannous chloride TS, **3**,
368
Trimethadione, **2**, 272; **3**, 385
Trimethadione RS, **2**, 325
Trimethadionum, **2**, 272; **3**, 385
Trimethoprim, **2**, 274; **5**, 279
Trimethoprim TS, **2**, 325
Trimethoprimum, **2**, 274; **5**, 279

2,2,4-Trimethylpentane R, **3**, 368
Trimethylpyridine R, (50 g/l) TS, **2**, 326
Trinitrophenol R, (7 g/l) TS, **2**, 326
 alkaline, TS, **2**, 326
Trinitrophenol/ethanol RS, **5**, 252
Triphenylantimony R, **3**, 368
Trisodium orthophosphate R, (2 g/l) TS, **3**, 368
Tropicamide, **5**, 144
Tropicamide RS, **5**, 252
Tropicamidum, **5**, 144
Tubocurarine chloride, **3**, 326
Tubocurarini chloridum, **3**, 326
Turbidity and nephelometry, **1**, 49
Tyrosine R, **2**, 326

U

Ultraviolet light, examination in, **2**, 12
Uncoated tablets, **4**, 29
Undue toxicity, **1**, 154
Uniformity of content for single-dose
 preparations, **4**, 46; **5**, 13
Uniformity of mass for single-dose
 preparations, **4**, 47; **5**, 13
Units of measurement, **1**, 13
Unsaponifiable matter, determination of, **1**,
139
Uranyl acetate R, **1**, 210
Uranyl/zinc acetate TS, **1**, 210
Urea R, **2**, 326
Uridine R, **3**, 368

V

Valproic acid RS, **3**, 368
Vanadium pentoxide R, **3**, 369
Vanadium/sulfuric acid TS, **3**, 369
Vanillin R, (10 g/l) TS, **2**, 326
Vanillin/hydrochloric acid TS, **3**, 369; **4**, 317
Vanillin/sulfuric acid TS1, **5**, 252, TS2, **5**, 253
Vaselineum album, *see* White soft paraffin
Vaselineum flavum, *see* Yellow soft paraffin
Verapamil hydrochloride, **3**, 328; **5**, 296
Verapamil hydrochloride RS, **3**, 369
Verapamili hydrochloridum, **3**, 328; **5**, 296
Vinblastine sulfate, **4**, 95; **5**, 304
Vinblastine sulfate RS, **4**, 309
Vinblastini sulfas, **4**, 95; **5**, 304
Vincristine sulfate, **3**, 330
Vincristine sulfate RS, **3**, 369
Vincristini sulfas, **3**, 330
Visual inspection of particulate matter in
 injectable preparations, **5**, 33
Vitamin B₁₂, *see* Cyanocobalamin
Vitamin B_{12a} and B_{12b}, *see* Hydroxocobalamin
Vitamin D₂, *see* Ergocalciferol
Vitamin K₁, *see* Phytomenadione

Volumetric solutions, **1**, 13
 reagents and test solutions, list of, **1**, 167;
2, 277; **3**, 337; **4**, 293; **5**, 235, 280, 296,
 314

W

Warfarin RS, **3**, 369
 Warfarin sodium, **3**, 332
 Warfarinum natricum, **3**, 332
 Water, **2**, 11
 ammonia-free, R, **2**, 326
 -bath, **2**, 12
 carbon-dioxide-free and ammonia-free, R,
2, 326
 carbon-dioxide-free, R, **1**, 211
 determination by the Karl Fischer method,
1, 134
 -emulsifying ointments, **4**, 44
 for injections, **4**, 132, **5**, 307, R, **5**, 253
 LAL, **5**, 253
 purified, **4**, 131; **5**, 306
 -soluble yeast extract R, **1**, 211
 sterile, **4**, 134; **5**, 307
 sterile, R, **2**, 326
 vapour detector tube, **5**, 253
 Well-closed containers, definition of, **1**, 12; **4**,
3
 Wheat starch, *see* Starches
 White petrolatum, *see* White soft paraffin
 White soft paraffin, **4**, 198
 Wool fat, **4**, 118
 hydrous, **4**, 118

X

Xanthidrol R, TS, **3**, 369
 Xylene R, **2**, 326
 Xylenol orange R, **1**, 211
 Xylenol orange indicator mixture R, **1**, 211

Y

Yeast extract, water-soluble, R, **1**, 211
 Yellow mercuric oxide, R, **1**, 191
 Yellow petrolatum, *see* Yellow soft paraffin
 Yellow soft paraffin, **4**, 198
 Yellow stock standard TS, **1**, 211

Z

Zinc, by complexometry, **1**, 129
 Zinc AsR, granulated, R, **1**, 211
 Zinc acetate R, **1**, 211
 Zinc bis(dibenzylthiocarbamate) R, TS, **3**,
 369
 Zinc chloride R, **2**, 236
 Zinc oxide, **3**, 335
 Zinc oxydum, **3**, 335
 Zinc standard (20 µg/ml Zn) TS, **2**, 327
 Zinc sulfate R, **2**, 327
 Zirconyl nitrate R, TS, **2**, 327
 Zuclofemifene RS, **5**, 297